



# Technical Catalogue

2019





TECHNICAL CATALOGUE 2019



## Filmop International: a world leader Italian company in the professional cleaning market

**Filmop** was founded in the early 70s as a company specialized in the manufacturing of manual cleaning equipment for professional use.

Located in the main production areas in the North East of Italy, it is a leading company in the professional cleaning and a reliable partner for thousands of professional people who operate in this market, proud to develop the **"Made in Italy"** trademark all over the world. This is why the company has always designed, planned and produced its own products only and exclusively in Italy.

It has a plant of about 30.000 square meters, including warehouses for storage of finished and semi-manufactured products, administration and commercial offices, marketing, production and assembly departments, and a laboratory for research and development.

Today **Filmop International** exports to over 80 countries worldwide with the maximum speed, reliability and efficiency. It has a French and an American branch (since 1997 and since 2004 respectively).

## Mission

Filmop International has always been inspired by the following main principles, that are surely behind its growth and development:

- An important spur to innovation and research
- A constant attention towards customer's satisfaction
- Unequaled production flexibility
- A considerable quick order processing with very fast and on time deliveries

FILMOP INTERNATIONAL PRIMARY GOAL IS TO DESIGN AND CREATE THE BEST CLEANING SYSTEMS PLACING AT THE CENTRE OF ANY NEW PROJECT THE WELLBEING AND HEALTH OF PEOPLE IN THE FULL RESPECT FOR THE ENVIRONMENT



## Your trusted partner

Filmop International is not merely a supplier of cleaning tools, but also a **trusted partner** totally oriented towards customer's satisfaction.

People choosing Filmop International know they can count on a **qualified, available and efficient partner**, organized to ship orders promptly with fast and on-time deliveries.

But the added value of the company is without doubt its **great manufacturing flexibility**: at every new customer's request there follows an immediate and careful research by the R&D department to identify and develop the best possible solution.

Moreover, Filmop International guarantees an excellent **pre- and after-sales service**, advising its customers on the cleaning system mostly fitting their own needs and supporting them with trainings on site and/or on its premises, with inspections at cleaning yards too.

Finally, the company provides its customers with different easy-to-use and accessible **marketing tools** to let them take a closer look at its products and services, such as:

- **Web site** with detailed and constantly updated information: technical sheets, catalogue downloads, updates on latest innovations and other information useful for customers
- **YouTube and Vimeo channels** with presentation videos and operating/handling instructions of the products
- **Alpha Configurator Software** in order to build autonomously one's own ideal professional cleaning trolley
- **New app YOU FIL** to consult easy the complete range of Filmop products with Tablet or Ipad and access any other always updated information

FILMOP INTERNATIONAL IS A TRUSTED PARTNER TOTALLY ORIENTED TOWARDS CUSTOMER'S SATISFACTION

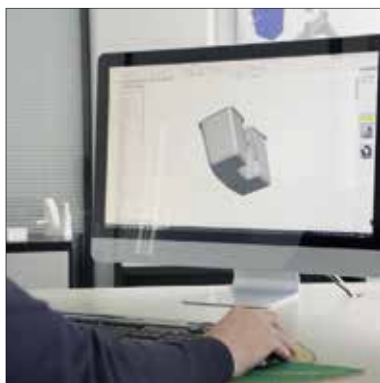

## The certifications obtained by Filmop International

The quality of the products and services offered by the company is guaranteed by the following certifications:

**Quality Certification UNI EN ISO 9001:2015** (certified company since 2000): Filmop International is based on an organized company system with an efficient management, appropriate structures and an adequate knowledge.

**Environmental Certification UNI EN ISO 14001:2015** (certified company since 2011): the company has decided to carry out its own environment management system to keep the environmental impact of its own activities under control.

**Plastic Second Life** (certified company since 2012): today Filmop International can offer a wide range of products made of recycled plastic materials.

**EU Ecolabel** certified company since 2015): for one microfiber flat mop line the company has obtained the prestigious EU Ecolabel certification, that rewards the best low environmental impact products, qualifying them in the market and differentiating them from the competitors.

**EPD** (certificated company since 2017): Filmop has increased its range of green products obtaining the EPD certification (Environmental Product Declaration) for the Alpha trolley with Top-Down pre-soaking system, ref. MA2606701U000. The uncertainty value for each environmental impact category has been inserted in the specific Life Cycle Evaluation (LCA Life Cycle Assessment), according to the UNI 11698:2017 rule.

The company satisfies the requirements of the European **REACH** regulation (since 2007): it purchases raw materials only from trusted and qualified suppliers, who declare to respect and follow the current laws concerning the supply chain.

On top of that, Filmop fulfils the criteria of **BRC** (since 2006): a structured management control system for hygiene supervision and product security.

FILMOP INTERNATIONAL HAS DEVELOPED TECHNICAL, ORGANIZATIONAL AND MANUFACTURING SKILLS THAT HAVE MADE IT POSSIBLE TO REACH HIGH COMPANY AND PRODUCT STANDARDS



Certification valid for Rapido Super microfiber mop line



Certification valid for Alpha trolley MA2606701U000

## A successful range of products

Innovation, research, development and sustainability are the keywords that have contributed to Filmop International growth. The Venetian company has always been successful thanks to its capacity to feel, get, understand and anticipate the requests and needs in the market; this is what differentiates a leading company from all the other ones operating in the same field.

Since its establishment the company has always been investing a lot in new technologies, thus being **one of the main figure** in the changing process affecting professional cleaning during the last 30 years.

In particular, Filmop International was the first Italian manufacturing company with a special attention to:

- **The importance of metal-replacing materials**, such as polypropylene, very strong, light and completely recyclable
- **The necessity to separate clean water from rinsing water**, a fundamental issue for a professional cleaning
- **Ergonomic cleaning systems** in order to make easier and improve the working conditions of the operators in the cleaning field

These three concepts are the main pillars of a successful business and production policy, that has led to a complete range of products for professional cleaning with more than 4.000 finished items.

INNOVATION, RESEARCH, DEVELOPMENT AND SUSTAINABILITY ARE THE KEYWORDS THAT HAVE CONTRIBUTED TO FILMOP INTERNATIONAL GROWTH



Fred



Morgan



Alpha



Emotion



Morgan Hotel



Speedy®



Duo Face®



Equodose®

## Filmop International engagement towards environment preservation and sustainable development

In an age in which the preservation of our environment is the world top priority, Filmop International is strongly engaged and oriented towards a policy of sustainable development.

Sustainable development is a process of change finalized to improve environmental, economic, social and institutional conditions of nations. This process implies an exploitation of natural resources, a direction of investments and an orientation of technological development totally respectful of the needs of today and future generations.

Filmop International contribution to these important goals finds fulfilment in its engagement:

- **To make the most of each person as a human being:** the company has a modern and avant-garde structure with wide offices featuring individual booths and working tools, respecting healthcare laws, bright warehouses and industrial machines in compliance with workers' safety. Moreover, Filmop International is strongly against the exploitation of minors' work, offers continuous employment to disabled people and can boast a staff with long term seniority (15 – 20 years).
- **To protect the environment:** today, compared to the past time, there are surely the means and knowledge to make conscious choices for environment preservation. Favouring products in compliance with EU laws and manufactured by certified companies can really make the difference.

Since the very beginning the company has indeed undertaken **a clear path towards eco-sustainability**. Many are the steps that translate the green soul of Filmop International into several concrete and certified results:

- Efficient organization of the separate collection of waste and leftovers deriving from production processes
- Environmental certifications
- Use of recycled raw materials
- Constant investment in the design of low environmental impact products, lasting over time and ergonomic for the benefit of workers health
- Selection of qualified suppliers according to REACH regulation for the supply of non-polluting, high-quality raw materials
- Offer of a wide range of 100% recycled products
- Energetic autonomy in the textile production: a photovoltaic plant has been functioning since 2011 and has made it possible an annual medium reduction of 110 ton of CO<sub>2</sub>

FILMOP INTERNATIONAL CONTRIBUTION TO SUSTAINABLE DEVELOPMENT FINDS FULFILMENT IN ITS ENGAGEMENT TO MAKE THE MOST OF EACH PERSON AS A HUMAN BEING AND TO PROTECT THE ENVIRONMENT



### YOUR GREEN PRODUCTS SUPPLIER

<p>Equodose® adjustable dispenser</p>  <p>to save cleaning solution</p>	<p>Wide range of high performance</p>  <p>dTex ≤ 1 microfibers</p>	<p>AlphaSplit System</p>  <p>to facilitate separate waste collection</p>	<p>7 lines of trolleys</p>  <p>certified PSV Plastic Second Life</p>
--	--	---	---



## Our certified products:

### Plastic Second Life

Confirming its own engagement to protect and respect the environment, and in compliance with the laws concerning the **Green Public Procurement**, Filmop International is proud to be the very first Italian manufacturer of janitorial products to get the **Plastic Second Life** certification by the Institute for the Promotion of Recycled Plastics (IPPR).

**PSV** (Italian acronym for Plastic Second Life) is the first Italian and European trademark for recycled plastic materials; a product's environmental certification to guarantee, highlight and identify more easily all products manufactured by using recycled plastics, simplifying the selection criteria for public authorities and for other companies, that are interested in buying eco-sustainable products.

Nowadays public authorities are obliged to meet their annual requirements for manufactured products and goods with a minimal level of products manufactured with recycled materials (Italy has taken into consideration the rules concerning Green Public Procurement with the law 448/01, the ministerial decree D.M. 203/03 and the ministerial memorandum dated 4 August 2004); consequently, all cleaning distributors selling to public authorities have now the possibility to offer PSV certified products and this means to be qualified as preferred suppliers in accordance with the policies defined in the **CAM** criterias (**Criteri Ambientali Minimi = Minimum Environmental Criteria**).

### EU Ecolabel

Filmop International has obtained the prestigious **Ecolabel UE** certification for its **RAPIDO SUPER** microfiber mops, the most common and widespread European Union environmental quality label among consumers.

EU Ecolabel rewards the best low environmental impact products, qualifying them in the market and differentiating them from the competitors, after having evaluated their sustainability over their entire life cycle through a very selective series of parameters established by the European Union.

According to the **National Action Plan** of Green Public Procurement (**PAN GPP**) this product certification, classified as Environmental Label Type I, is indeed the main reference for the identification of the **best products** from the point of view of **environmental sustainability** and, consequently, it is at the basis of the Italian legislation in relation to Green Public Procurement.

«...These "Minimum Environmental Criteria" are highly consistent with the criteria for the award of the "Community EU Ecolabel" trademark...» - (Extract from **CAM for the cleaning service** - D.L. dtd 24 May 2012)

The complete range of Rapido Super microfiber mops with EU Ecolabel certification is available in the official web site of Ispra Ambiente, see the web page: <http://www.isprambiente.gov.it/it/certificazioni/ecolabel-ue/prodotti-certificati>

PREFER PRODUCTS WITH ENVIRONMENTAL CERTIFICATIONS: A PRECIOUS ADDED VALUE TO BE QUALIFIED AS A SUPPLIER OF ECO-FRIENDLY PRODUCTS, A RESPONSIBLE CHOICE FOR ENVIRONMENTAL PROTECTION

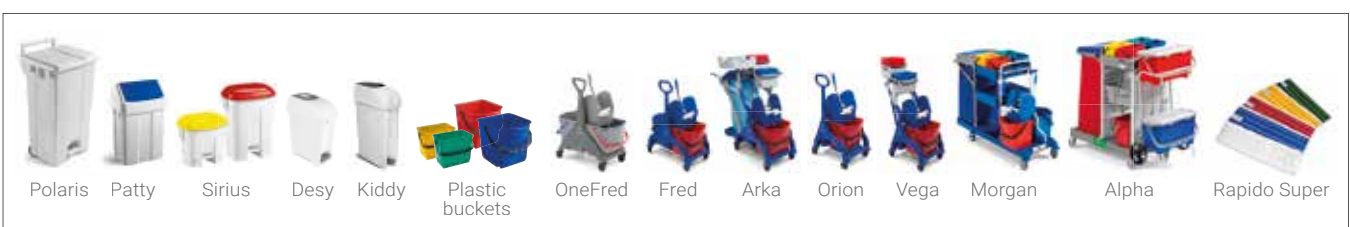

## **NEW** A window always open on the Filmop world

A concentrate of **useful details and practical recommendations** in a new graphic style: the Filmop website now includes content capable of meeting the specific requirements of the various sectors, brought together by the need of ensuring clean and healthy environments.

A new online resource available to all, consistently offering **indications and suggestions** based on decades of professional cleaning experience.

### Explore the new website

- Discover the wide range of **products** and their individual features, technical details and applications.
- Learn about the top Filmop **systems**, the various options available and their correct uses.
- Rely on our **recommendations** on the best tool based on the specific application and environment of use.
- Keep up to date with what's happening at Filmop through the **articles** of our publications; discover specific product features through our **videos** tutorials
- Visit and download our **catalogues, technical data sheets**, and the many company and product **certificates** held by the company



# You Fil: Filmop world in your hands

Filmop is completely at your disposal thanks to the **new You Fil app**.

**You Fil** allows you to:

- comfortably explore **our full range of products**
- discover their features and functions thanks to the available **videos**
- download the **catalogues** you need
- share **technical sheets**
- consult the obtained **certifications**
- customize your **favourite product playlist**
- always be updated on **all the latest news**

**You Fil** is easy to use, fast and available, wherever you are: once it has been downloaded on your device, you can **consult it even offline**.

Available both for **Tablets** (Android operating system) and **iPad** (iOs operating system).



## The right tool for every situation!

Filmop International is constantly committed to better satisfy all your needs.

You can **consult freely** our range of products according to the specific situation and requirements, choosing the easier instrument for you!



Technical Catalogue

General Catalogue

Web site

App You Fil

## Create your ideal trolley with Alpha Configurator

Do you think all the trolleys for professional cleaning are the same? You can finally create your ideal trolley with **Alpha Configurator**, the innovative application developed by Filmop International for distributors, cleaning companies and cleaning operators.

Just a few simple clicks and you can create your custom-made multipurpose trolley for the professional cleaning of environments according to your specific needs. Have fun with total freedom of choice of compartments, washing systems, doors, colours and accessories.

Alpha Configurator software is available both for **PC** and for mobile devices: **iPad** and **Tablet**.

WITH ALPHA CONFIGURATOR YOU CAN ENJOY CREATING YOUR IDEAL TROLLEY FOR PROFESSIONAL CLEANING ACCORDING TO YOUR SPECIFIC NEEDS

... do you think all the **trolleys look the same?**

*Express your Style*  
create your ideal trolley with

# Alpha

configurator



- Discover the endless combinations and the wide range of accessories available to meet all your requirements for a specific customized product
- Save and send us the projects of your Alpha trolleys: you will get any support and our best quotations for the requested versions
- Change, share and store your configurations
- Check immediately your configurations complete with your purchasing net prices
- Mark up your sales prices



## **NEW** Your ideal trolley with a click

With the **new 3D Alpha Configurator** of Filmop International it is even easier to create a multipurpose trolley, customized right to the smallest detail: discover all the features of the new version, explore the wide range of products and start creating your ideal trolley!

- Modern design
- High definition images
- Intuitive and easy to use interface
- Several combinations available
- Always updated products
- New interactive tools

## Maintenance and care of textile products

Filmop International **guarantees high-quality products**, resistant, strong, recyclable and ergonomic beyond doubt; they are the result of a careful and accurate research and selection of raw materials.

Any product has to be used in the right and proper way in order to last longer and to keep its main features and performances as much and as long as possible.

As far as all textile products are concerned, please, follow very carefully the **washing instructions** here below:

- Read the washing instructions on the package of the detergent carefully before washing
- Do not use softener
- Do not use chlorine or bleach
- Use alkaline detergents with PH <11
- The use of the specific net bags for washing is recommended
- As regards microfiber mops at least a pre-wash cycle in cold water is recommended in order to remove residual detergent or disinfectant
- The mentioned washing temperatures refer only to washing with water, without detergent

For further details, please, visit our web site [www.filmop.com](http://www.filmop.com) or consult our product sheets, asking our sales staff for them.

**MADE IN ITALY**



## General safety of plastic, metal and mixed products

Our products do not need product certification, as they meet the definition of Italian Legislative Decree 115 of 17.03.95.

Based on such decree, a safe product is a product that during normal or reasonably predictable use, including in terms of duration, does not pose any hazards or only minimum hazards, compatible with the use of the product itself.

The items listed, produced by **FILMOP INTERNATIONAL S.r.l.** are not within the scope of any European Product Directives. In specific, they are not within the scope of the 93/37/EC Machine Directive, the 73/23/EC Low Voltage Directive and the 89/336/EC Electromagnetic Compatibility Directive.

Also, no specific risks connected with the cleaning items or systems of relevance have been identified.

The material used are all materials which don't constitute a chemical health hazard to the end users

The company constantly monitors the materials used, keeping their safety data sheets on file.

As far as safety is concerned, it must be pointed out that the product may not be used by non-professional users, or on non-level surfaces with slopes exceeding 1%.

It is also recommended that the items are stored away from the reach of children.

Lastly, the company shall not be held responsible for any damage caused by the substances used by operators.

## Safety of electric items and motor-driven trolleys

Our electric items - Aura range - meet the 89/336/EEC Electromagnetic Compatibility Directive and are all CE marked.

Our motor-driven trolleys meet the essential safety requirements of Attached I of the 2006/42/EC Machine Directive, the requirements of the 2014/35/EU Low Voltage Directive and of the 89/336/EEC Electromagnetic Compatibility Directive.

Also as far as motor-driven trolleys:

- The **RISK** assessment has been completed in compliance with UNI EN 12100:2010
- The **MECHANICAL** hazard assessment has been completed in compliance with UNI EN ISO 14120
- The **ELECTRICAL** hazard assessment has been completed in compliance with IEC 60204

Before using electric items and motor-driven trolleys, the operator must read the instruction booklet, which must be strictly followed. For any doubts, the operator can refer to the Manufacturer or the available Support Centres.

The materials used for the manufacturing of electric items and motor-driven trolleys are all materials that do not pose any chemical hazards for the health of users. The company constantly monitors the materials used, keeping their safety data sheets on file.

However, the batteries of motor-driven trolleys must be treated in compliance with the instruction booklet provisions and instructions for their conservation and replacement.

Motor-driven trolleys must only be used for transporting cleaning materials and items, laundry and similar, and always by qualified professional personnel, meaning personnel trained by the employer on their use and the risks that such use may entail. All the provisions of the instruction booklet must be followed during use. It is also recommended that the items are stored away from the reach of children.

Lastly, the manufacturer shall not be held responsible for any damage caused by the use of the electric items and the motor-driven trolleys produced by the operator.

## Compliance Declaration

All Filmop International products are in full compliance with the laws in force regarding safety and covered by a "product liability" **insurance policy**.



# Floor care and dusting

- Dust mopping
- Damp mopping
- Dustpans
- Industrial brooms
- Household articles
- Equipment for wax application
- Pad holders
- Scrapers
- Floor squeegees





# Floor care and dusting

- DUST MOPPING**
- DAMP MOPPING
- DUSTPANS
- INDUSTRIAL BROOMS
- HOUSEHOLD ARTICLES
- EQUIPMENT FOR WAX APPLICATION
- PAD HOLDERS
- SCRAPERS
- FLOOR SQUEEGEES

**Dust mopping** with flat mops and the specific mop holders is the ideal system to collect and keep the dust, unlike the household brooms which just raise the dust to let it deposit on the floor again afterwards. Filmop dust mops are available in different sizes from 40 to 160 cm.

## YARNS



### COTTON

Natural highly absorbing fiber that keeps dirt, releasing it only during the washing of the mop. It is available in three versions: 100% cotton, mixed cotton or first rate (regenerated) cotton.

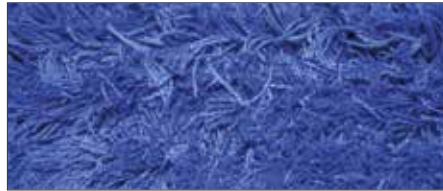

### ACRYLIC

A high electrostatic charged fiber that collects and attracts dust particles, thus increasing the performances of the mop.



### MICROFIBER

It is a synthetic fiber which penetrates deep into the grooves and pores of floors, absorbing the removed dirt and retaining it till mop washing.



*Please, refer to page 11 for the washing instructions.*

## KIND OF SUPPORT



**Strings**



**Pockets**



**Buttons**



**Velcro system**

## Dust mops

### 100% cotton mop with buttons



REF.	NOTES	PCK	VOLUME (m³)	GROSS WEIGHT (kg)	SIZE (cm) ↓ ↓ ↓
5141		25	0,028	5,57	40
5161		25	0,043	7,33	60
5181		25	0,064	9,53	80
5111		25	0,083	11,72	100

### 100% cotton pocket mop



REF.	NOTES	PCK	VOLUME (m³)	GROSS WEIGHT (kg)	SIZE (cm) ↓ ↓ ↓
5141/1		25	0,024	4,42	40
5161/1		25	0,033	5,61	60
5181/1		25	0,052	7,2	80
5111/1		25	0,083	9,47	100

### Normal cotton mop with buttons



REF.	NOTES	PCK	VOLUME (m³)	GROSS WEIGHT (kg)	SIZE (cm) ↓ ↓ ↓
5142		25	0,028	5,43	40
5162		25	0,043	7,58	60
5182		25	0,064	10,28	80
5112		25	0,083	12,22	100



**DUST MOPPING**

DAMP MOPPING

DUSTPANS

 INDUSTRIAL  
BROOMS

 HOUSEHOLD  
ARTICLES

 EQUIPMENT FOR  
WAX APPLICATION

PAD HOLDERS

SCRAPERS

 FLOOR  
SQUEEGEES

## Normal cotton pocket mop



REF.	NOTES	PCK	VOLUME (m³)	GROSS WEIGHT (kg)	SIZE (cm) ↓ ↓ ↓
5142/1		25	0,028	4,43	40
5162/1		25	0,033	6,36	60
5182/1		25	0,052	8,2	80
5112/1		25	0,083	10,47	100

## Blue acrylic mop with buttons



REF.	NOTES	PCK	VOLUME (m³)	GROSS WEIGHT (kg)	SIZE (cm) ↓ ↓ ↓
5144		25	0,028	4,07	40
5164		25	0,043	6,08	60
5184		25	0,064	7,78	80
5114		25	0,083	9,22	100

## Blue acrylic pocket mop



REF.	NOTES	PCK	VOLUME (m³)	GROSS WEIGHT (kg)	SIZE (cm) ↓ ↓ ↓
5144/1		25	0,028	3,18	40
5164/1		25	0,033	4,61	60
5184/1		25	0,052	5,95	80
5114/1		25	0,083	7,72	100

## First rate cotton mop with polyester backing and strings



REF.	NOTES	PCK	VOLUME (m³)	GROSS WEIGHT (kg)	SIZE (cm) ↓ ↓ ↓
5746		25	0,028	5,43	40
5766		25	0,043	7,58	60
5786		25	0,064	10,03	80
5716		25	0,083	11,97	100

## Blue acrylic mop with polyester backing and strings



REF.	NOTES	PCK	VOLUME (m³)	GROSS WEIGHT (kg)	SIZE (cm) ↓ ↓ ↓
5147		25	0,028	3,68	40
5167		25	0,043	5,33	60
5187		25	0,064	7,03	80
5117		25	0,083	8,47	100
5178/2		15	0,049	6,09	110
5128/2		15	0,043	6,13	120
5138/2		15	0,043	6,28	130
5158/2		15	0,064	7,68	160

## 100% cotton mop with polyester backing and strings



REF.	NOTES	PCK	VOLUME (m³)	GROSS WEIGHT (kg)	SIZE (cm) ↓ ↓ ↓
5176/2		15	0,043	7,93	110
5126/2		15	0,049	8,43	120
5136/2		15	0,049	9,03	130
5156/2		15	0,064	10,98	160

## Set of 100% cotton V-sweeper mop with buttons



REF.	NOTES	PCK	VOLUME (m³)	GROSS WEIGHT (kg)	SIZE (cm) ↓ ↓ ↓
5101	for mop holder art. 5201 - 5201/1	12	0,083	11,77	100

**DUST MOPPING**

DAMP MOPPING

DUSTPANS

INDUSTRIAL  
BROOMSHOUSEHOLD  
ARTICLESEQUIPMENT FOR  
WAX APPLICATION

PAD HOLDERS

SCRAPERS

FLOOR  
SQUEEGEES
**Set of normal cotton V-sweeper mop with buttons**

REF.	NOTES	PCK	VOLUME (m³)	GROSS WEIGHT (kg)	SIZE (cm) ↓ ↓ ↓
5102	for mop holder art. 5201 - 5201/1	12	0,083	12,01	100

**Set of blue acrylic V-sweeper mop with buttons**

REF.	NOTES	PCK	VOLUME (m³)	GROSS WEIGHT (kg)	SIZE (cm) ↓ ↓ ↓
5104	for mop holder art. 5201 - 5201/1	12	0,083	9,37	100

**Set of first rate cotton V-sweeper mop with polyester backing and strings**

REF.	NOTES	PCK	VOLUME (m³)	GROSS WEIGHT (kg)	SIZE (cm) ↓ ↓ ↓
5706	for mop holder art. 5201 - 5201/1	12	0,083	11,77	100

**Set of blue acrylic V-sweeper mop with polyester backing and strings**

REF.	NOTES	PCK	VOLUME (m³)	GROSS WEIGHT (kg)	SIZE (cm) ↓ ↓ ↓
5107	for mop holder art. 5201 - 5201/1	12	0,083	8,17	100

**RAPIDO - white microfibre mop head for large surfaces, with Velcro backing**

REF.	NOTES	PCK	VOLUME (m³)	GROSS WEIGHT (kg)	SIZE (cm) ↓ ↓ ↓
0000246DA	for mop holder art. 5201/28 and art. 5278	14	0,015	2,71	80x10
0000247DA	for mop holder art. 5201/21 and art. 5278	10	0,015	2,39	100x10



- DUST MOPPING
- DAMP MOPPING
- DUSTPANS
- INDUSTRIAL BROOMS
- HOUSEHOLD ARTICLES
- EQUIPMENT FOR WAX APPLICATION
- PAD HOLDERS
- SCRAPERS
- FLOOR SQUEEGEES



**The mop holders for dust mopping** are made of metal, metal and plastic or completely made of plastic. It is possible to choose the best solution to meet one's own needs: foldable mop holders to set the mop easier or fixed mop holders. We advise the longest sizes, from 110 up to 160 cm, or the V-sweeper dust mop holders for the cleaning of wide areas.

## Mop holders for dust mops

### Foldable metal dust mop holder with metal joint



REF.	NOTES	PCK	VOLUME (m³)	GROSS WEIGHT (kg)	SIZE (cm) ↓ ↓ ↓
5241		25	0,028	9,53	40
5261		25	0,043	11,83	60
5281		25	0,064	15,03	80
5211	reinforced	25	0,083	23,47	100

### Foldable metal dust mop holder with plastic joint



REF.	NOTES	PCK	VOLUME (m³)	GROSS WEIGHT (kg)	SIZE (cm) ↓ ↓ ↓
5241/PA		25	0,035	8,99	40
5261/PA		25	0,049	11,38	60
5281/PA		25	0,064	14,53	80
5211/PA	reinforced	25	0,083	22,97	100

### Foldable dust mop holder with plastic plate and joint



REF.	NOTES	PCK	VOLUME (m³)	GROSS WEIGHT (kg)	SIZE (cm) ↓ ↓ ↓
5341A		25	0,035	6,74	40
5361A		25	0,049	8,38	60
5381A		25	0,064	11,03	80
5311A	reinforced	25	0,083	17,22	100

### Fixed plastic dust mop holder



REF.	NOTES	PCK	VOLUME (m³)	GROSS WEIGHT (kg)	SIZE (cm) ↓ ↓ ↓
5342H		25	0,035	6,04	40
5362H		25	0,049	9,53	60

### Foldable plastic mop holder with pedal opening device



REF.	NOTES	PCK	VOLUME (m³)	GROSS WEIGHT (kg)	SIZE (cm) ↓ ↓ ↓
5540		15	0,028	3,6	40
5560		15	0,043	4,42	60



# Floor care and dusting

DUST MOPPING

DAMP MOPPING

DUSTPANS

INDUSTRIAL  
BROOMSHOUSEHOLD  
ARTICLESEQUIPMENT FOR  
WAX APPLICATION

PAD HOLDERS

SCRAPERS

FLOOR  
SQUEEGEES

Foldable plastic mop holder with button opening device



REF.	NOTES	PCK	VOLUME (m³)	GROSS WEIGHT (kg)	SIZE (cm) ↓ ↓ ↓
5442		15	0,028	3,7	40
5462A		15	0,043	4,7	60

## Mop holder for big areas

Fixed metal dust mop holder with two supports



REF.	NOTES	PCK	VOLUME (m³)	GROSS WEIGHT (kg)	SIZE (cm) ↓ ↓ ↓
5271		10	0,065	16,27	110
5221		10	0,065	17,33	120
5231		10	0,065	17,83	130
5251		10	0,074	18,47	160

Fixed metal dust mop holder with plastic joint



REF.	NOTES	PCK	VOLUME (m³)	GROSS WEIGHT (kg)	SIZE (cm) ↓ ↓ ↓
5271/PA		10	0,052	12,9	110
5221/PA		10	0,052	17,44	120
5231/PA		10	0,052	17,94	130
5251/PA		10	0,074	18,47	160

Wooden V-sweeper dust mop holder



REF.	NOTES	PCK	VOLUME (m³)	GROSS WEIGHT (kg)	SIZE (cm) ↓ ↓ ↓
5201		10	0,078	17,66	100

Metal V-sweeper dust mop holder



REF.	NOTES	PCK	VOLUME (m³)	GROSS WEIGHT (kg)	SIZE (cm) ↓ ↓ ↓
5201/1		10	0,062	21,39	100

Plastic V-sweeper mop holder with velcro system



REF.	NOTES	PCK	VOLUME (m³)	GROSS WEIGHT (kg)	SIZE (cm) ↓ ↓ ↓
5201/28A		10	0,064	16,82	80
5201/21		10	0,083	19,75	100



**DUST MOPPING**

DAMP MOPPING

DUSTPANS

INDUSTRIAL BROOMS

HOUSEHOLD ARTICLES

EQUIPMENT FOR WAX APPLICATION

PAD HOLDERS

SCRAPERS

FLOOR SQUEEGEES

## Chromed V-sweeper handle



REF.	NOTES	PCK	VOLUME (m³)	GROSS WEIGHT (kg)	SIZE (cm) ↓ ↓ ↓
5202		5	0,054	10,09	134

## Chromed V-sweeper handle with central plastic reinforcement



REF.	NOTES	PCK	VOLUME (m³)	GROSS WEIGHT (kg)	SIZE (cm) ↓ ↓ ↓
5203		5	0,054	10,21	134

## Articulated plastic connection with screws for V-sweeper handle art.5203



REF.	NOTES
5503	





# Floor care and dusting

DUST MOPPING

**DAMP MOPPING**

DUSTPANS

INDUSTRIAL BROOMS

HOUSEHOLD ARTICLES

EQUIPMENT FOR WAX APPLICATION

PAD HOLDERS

SCRAPERS

FLOOR SQUEEGEES

**Damp mopping** is very important because it allows to collect and keep also the smallest dust particles reducing micro-organisms in the air. Filmop offers mop holders with rubber blades or lamellas or mop holders with foam soles for pre-soaked cloths or cotton gauzes. The special trapezoidal shaped mop holders allow to clean edges and hard-to-reach areas, they are light and handy.

All Filmop mop holders can be equipped with **Lock System** that improves the cleaning of walls and ceilings just locking and unlocking the joint simply pushing up and down the special device using one's foot.



### MOP HOLDERS WITH VELCRO SYSTEM

Thanks to the wide range of accessories, like foam soles, mop and pads, the mop holders with velcro system can be used for different cleaning operations.



### CLOTH HOLDERS WITH RUBBER BLADES OR LAMELLAS

The 30° inclination of the flexible rubber blades allows to collect all dust particles assuring the utmost hygiene also on uneven floors. The cloth holders with rubber blades or lamellas are **washable** and **sterilizable**.



### MOP HOLDER WITH FOAM SOLE

The mop holders with foam sole are light and practical, they are suitable also for uneven surfaces. Available in 2 versions: cloth holders with incorporated foam sole or cloth holder with velcro system with removable foam sole

### Unlocked joint: floor mopping



### Locked joint: cleaning of walls and ceilings



## Cloth holder with rubber blades and with foam sole

### SPARK - cloth holder with rubber blades



Autoclavable

REF.	NOTES	PCK	VOLUME (m³)	GROSS WEIGHT (kg)	SIZE (cm) ↓ ↓ ↓
72000A		1	0,006	0,68	40
72001A		1	0,006	0,85	60
72002A		1	0,008	1,33	80

### SPARK - cloth holder with rubber blades, with Lock System



Autoclavable

REF.	NOTES	PCK	VOLUME (m³)	GROSS WEIGHT (kg)	SIZE (cm) ↓ ↓ ↓
73000A		1	0,006	0,69	40

### SPARK - tool with rubber blades and ErgoSwing joint

**NEW**



Autoclavable - use with ErgoSwing system handle, code 0000AM3045

REF.	NOTES	PCK	VOLUME (m³)	GROSS WEIGHT (kg)	SIZE (cm) ↓ ↓ ↓
79000A		1	0,006	0,72	40



DUST MOPPING

**DAMP MOPPING**

DUSTPANS

INDUSTRIAL BROOMS

HOUSEHOLD ARTICLES

EQUIPMENT FOR WAX APPLICATION

PAD HOLDERS

SCRAPERS

FLOOR SQUEEGEES

**SPARK** - cloth holder with rubber blades complete with chromed handle 140 cm - 2 pcs



REF.	NOTES	PCK	VOLUME (m³)	GROSS WEIGHT (kg)	SIZE (cm) ↓ ↓ ↓
172000A		1	0,008	1,08	40
172001A		1	0,008	1,73	60

**FLEXY** - cloth holder with rubber blades complete with chromed metal handle 140 cm - 2 pcs



REF.	NOTES	PCK	VOLUME (m³)	GROSS WEIGHT (kg)	SIZE (cm) ↓ ↓ ↓
5225A		1	0,008	1,63	60

Cloth holder with foam sole complete with chromed metal handle 140 cm - 2 pcs



REF.	NOTES	PCK	VOLUME (m³)	GROSS WEIGHT (kg)	SIZE (cm) ↓ ↓ ↓
5213A		1	0,008	1,2	40
5212A		1	0,008	1,31	60

Cloth holder with foam sole, no handle



REF.	NOTES	PCK	VOLUME (m³)	GROSS WEIGHT (kg)	SIZE (cm) ↓ ↓ ↓
100/5213A		10	0,028	3,83	40
100/5212A		10	0,043	5,08	60

Cloth holder with velcro system and replaceable foam sole, complete with chromed handle 140 cm - 2 pcs



REF.	NOTES	PCK	VOLUME (m³)	GROSS WEIGHT (kg)	SIZE (cm) ↓ ↓ ↓
5252A		1	0,008	1,19	40
5254A		1	0,008	1,19	60

## Rapido mop holders

**RAPIDO** - plastic holder with back fixing hooks



REF.	NOTES	PCK	VOLUME (m³)	GROSS WEIGHT (kg)	SIZE (cm) ↓ ↓ ↓
0000TA0001A		10	0,019	2,73	40

Pad for cloth holder with velcro system



REF.	NOTES	PCK	VOLUME (m³)	GROSS WEIGHT (kg)	SIZE (cm) ↓ ↓ ↓
5224		25	0,019	0,84	40
5223		25	0,03	1,19	60



DUST MOPPING

**DAMP MOPPING**

DUSTPANS

INDUSTRIAL  
BROOMSHOUSEHOLD  
ARTICLESEQUIPMENT FOR  
WAX APPLICATION

PAD HOLDERS

SCRAPERS

FLOOR  
SQUEEGEES

## Components and accessories for holders with rubber blades and with foam sole

### Plastic joint with articulation



REF.	NOTES
<b>4008A</b>	

### Lock System plastic joint



REF.	NOTES
<b>4028AB</b>	

### Round cloth star fixing clip



REF.	NOTES
<b>60062U</b>	

### Autoclavable round cloth star fixing clip for Spark cloth holders



REF.	NOTES
<b>P191061E</b>	

### Foam sole for cloth holder with velcro system



REF.	NOTES	PCK	VOLUME (m <sup>3</sup> )	GROSS WEIGHT (kg)	SIZE (cm) ↓ ↓ ↓
<b>5247</b>		125	0,095	1,75	30
<b>5239</b>		25	0,028	1,18	40
<b>5240</b>		25	0,043	1,78	60

## Cotton gauzes and cloths

### Cotton gauze in roll h 80 cm



REF.	NOTES	PCK	VOLUME (m <sup>3</sup> )	GROSS WEIGHT (kg)
<b>5220</b>	roll 100 mt long	100	0,03	7,6

Available while stocks last

### Hemmed cotton gauze



REF.	NOTES	PCK	VOLUME (m <sup>3</sup> )	GROSS WEIGHT (kg)	SIZE (cm) ↓ ↓ ↓
<b>5215</b>		300	0,106	15,51	60x80
<b>5216</b>		250	0,106	19,11	80x100
<b>5217</b>		200	0,106	21,11	80x140
<b>5219</b>		200	0,106	21,11	80x120

Item sold in polybags with 25 pcs each

Available while stocks last





DUST MOPPING

**DAMP MOPPING**

DUSTPANS

INDUSTRIAL BROOMS

HOUSEHOLD ARTICLES

EQUIPMENT FOR WAX APPLICATION

PAD HOLDERS

SCRAPERS

FLOOR SQUEEGEES

## White pre-soaked disposable cloth



REF.	NOTES	PCK	VOLUME (m³)	GROSS WEIGHT (kg)	SIZE (cm) ↓ ↓ ↓
<b>50001</b>	pck.: 20 polybags with 50 pcs	1	0,024	2,97	17x60
<b>50002</b>	pck.: 20 polybags with 50 pcs	1	0,023	3,3	20x60
<b>50003</b>	pck.: 20 polybags with 50 pcs	1	0,035	4,54	30x60
<b>50011</b>	pck.: 12 polybags with 50 pcs	1	0,024	2,44	20x85

## Coloured pre-soaked disposable cloth



REF.	NOTES	PCK	VOLUME (m³)	GROSS WEIGHT (kg)	SIZE (cm) ↓ ↓ ↓
<b>50100S</b>	pck.: 40 polybags with 25 pcs	1	0,029	3,15	25x42
<b>5206</b>	pck.: 10 polybags with 50 pcs	1	0,024	3,73	20x60
<b>5210</b>	pck.: 10 polybags with 50 pcs	1	0,067	11,11	57x60

## Pre-soaked disposable cloth in roll



REF.	NOTES	PCK	VOLUME (m³)	GROSS WEIGHT (kg)	SIZE (cm) ↓ ↓ ↓
<b>0000PN0501</b>	pck.: 20 rolls with 50 tears	1	0,024	2,5	17x60
<b>0000PN0502</b>	pck.: 20 rolls with 50 tears	1	0,024	2,8	20x60

## QUIK-STIK - Disposable antistatic cloth

**NEW**



REF.	NOTES	PCK	VOLUME (m³)	GROSS WEIGHT (kg)	SIZE (cm) ↓ ↓ ↓
<b>00PU0001000</b>	Pkg: 08 polybags with 50 pcs each	1	0,05	3,8	22x60

## QUIK-STIK - Disposable cloth with glue

**NEW**



REF.	NOTES	PCK	VOLUME (m³)	GROSS WEIGHT (kg)	SIZE (cm) ↓ ↓ ↓
<b>00PU0101000</b>	Pkg: 8 rolls with 50 tears	1	0,037	3,13	20x60



DUST MOPPING

**DAMP MOPPING**

DUSTPANS

INDUSTRIAL BROOMS

HOUSEHOLD ARTICLES

EQUIPMENT FOR WAX APPLICATION

PAD HOLDERS

SCRAPERS

FLOOR SQUEEGEES

**Dry-Up, the high absorbent disposable cloth** made by Filmop, lets you solve any loss of liquid instantly: thanks to its performances, surfaces dry very quickly with the highest hygiene, allowing to continue with the ongoing activities.



- **High absorbency in a few seconds:** the high absorbing polymers of the cloth soak up till 1000 ml from 30 to 150 seconds. Absorbing time and capacity depend on the type of liquid: Dry-Up can indeed absorb water, drinks, chlorine bleach, oil, urine and blood.
- **Maximum safety and hygiene:** the absorbed liquid is bonded safe in the cloth and transformed into gel, allowing a safe and hygienic disposal of the cloth, neither dripping nor trickle, and avoiding cross contamination.
- **High versatility:** perfect to be used in healthcare facilities, elderly homes, restaurants, bars, supermarkets, communities, schools, airports, public toilets, industries, mechanical workshops.

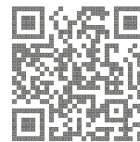

Put Dry-Up onto the leakage of liquid and wait until it absorbs it completely. If necessary, move it slightly without lifting it to absorb the rest of the liquid. Do not step on it, because it could be slippery.

Remove Dry-Up. The liquid, now transformed into gel, is bonded safe in the cloth, avoiding dripping and trickling. Dry-Up leaves the surface completely dry, allowing a fast restart of ongoing activities.

Dispose of the cloth as general waste (please, comply with the specific protocol for hospital waste). Then proceed with the cleaning of the area.

## DRY-UP - super-absorbing disposable cloth



REF.	NOTES	PCK	VOLUME (m <sup>3</sup> )	GROSS WEIGHT (kg)	SIZE (cm) ↓ ↓ ↓
0000PN02060		10	0,005	0,37	45x33
0000PN02069	pck.: 5 polybags with 10 pcs	1	0,025	2,07	45x33



DUST MOPPING

DAMP MOPPING

**DUSTPANS**

INDUSTRIAL BROOMS

HOUSEHOLD ARTICLES

EQUIPMENT FOR WAX APPLICATION

PAD HOLDERS

SCRAPERS

FLOOR SQUEEGEES

## Baggy and Jobby with folding hand grip

Baggy and Jobby dust pans are also available in the space-saving **folding hand grip** and shock resistant versions.

The grip closes with a simple click on the press-button, guaranteeing a minimal volume, a compact design, avoiding any accidental entanglement, especially during transport and storing of the trolley.

## Pocker dustpan with wheels

The Pocker dustpan has a practical **handle** and 80 mm **wheels** for better ergonomics and practicality of use and transport.

Pocker is also available in the **4-wheel version** for easier manoeuvrability and handling, particularly during the collection of waste.



## Dustpans with floor squeegee

**KIT BAGGY** - dustpan with rubber profile, floor squeegee with rubber blade and no. 10 bags 50x60 cm



REF.	NOTES	PCK	VOLUME (m <sup>3</sup> )	GROSS WEIGHT (kg)
0000PA20400		6	0,067	6,1



**BAGGY** - dustpan with rubber profile, foldable grip, aluminium handle and bag fixing device, h 82 cm



REF.	NOTES	PCK	VOLUME (m <sup>3</sup> )	GROSS WEIGHT (kg)
0000PA10400		6	0,067	3,43





DUST MOPPING

DAMP MOPPING

**DUSTPANS**INDUSTRIAL  
BROOMSHOUSEHOLD  
ARTICLESEQUIPMENT FOR  
WAX APPLICATION

PAD HOLDERS

SCRAPERS

FLOOR  
SQUEEGEES
**KIT BAGGY** - dustpan with rubber profile, floor squeegee with rubber blade and no.10 bags 50x60 cm

REF.	NOTES	PCK	VOLUME (m <sup>3</sup> )	GROSS WEIGHT (kg)
0000PA20300		6	0,067	6,1

**BAGGY** - dustpan with rubber profile, aluminium handle, bag fixing device, plastic grip with handle support - h 82 cm

REF.	NOTES	PCK	VOLUME (m <sup>3</sup> )	GROSS WEIGHT (kg)
0000PA10300		6	0,067	3,43

Floor squeegee for Baggy dustpan 32 cm with aluminium handle - h 97 cm



REF.	NOTES	PCK	VOLUME (m <sup>3</sup> )	GROSS WEIGHT (kg)
0000SC10200		6	0,011	1,88

Floor squeegee for Baggy dustpan 32 cm, no handle



REF.	NOTES	PCK	VOLUME (m <sup>3</sup> )	GROSS WEIGHT (kg)
0000SC00200		12	0,006	1,24

Set of 10 bags 50x60 cm for Baggy dustpan



REF.	NOTES	PCK	VOLUME (m <sup>3</sup> )	GROSS WEIGHT (kg)
SAC025		80	0,04	13,76



DUST MOPPING

DAMP MOPPING

**DUSTPANS**

INDUSTRIAL BROOMS

HOUSEHOLD ARTICLES

EQUIPMENT FOR WAX APPLICATION

PAD HOLDERS

SCRAPERS

FLOOR SQUEEGEES

Floor squeegee 55 cm with joint, no handle



REF.	NOTES	PCK	VOLUME (m³)	GROSS WEIGHT (kg)
0000SC00211		12	0,03	3,15

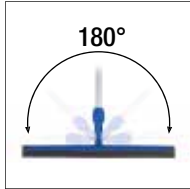

180° articulation

## Dustpans with brooms

**JOBBY** - plastic coloured dustpan with aluminium handle and foldable grip, without cover



REF.	NOTES	PCK	VOLUME (m³)	GROSS WEIGHT (kg)
000010404A		6	0,073	4,57
000010404B		6	0,073	4,57
000010404C		6	0,073	4,57
000010404F		6	0,073	4,57
000010404H		6	0,073	4,57



With serrated edge for an easy removal of the dirt from the broom

**JOBBY** - plastic coloured dustpan with aluminium handle, without cover



REF.	NOTES	PCK	VOLUME (m³)	GROSS WEIGHT (kg)
000010104A		6	0,073	4,57
000010104B		6	0,073	4,57
000010104C		6	0,073	4,57
000010104F		6	0,073	4,57
000010104H		6	0,073	4,57



With serrated edge for an easy removal of the dirt from the broom



# Floor care and dusting

- DUST MOPPING
- DAMP MOPPING
- DUSTPANS**
- INDUSTRIAL BROOMS
- HOUSEHOLD ARTICLES
- EQUIPMENT FOR WAX APPLICATION
- PAD HOLDERS
- SCRAPERS
- FLOOR SQUEEGEES

**JOBBY** - plastic coloured dustpan with aluminium handle, foldable grip and black cover



REF.	NOTES	PCK	VOLUME (m³)	GROSS WEIGHT (kg)
000010405A		6	0,073	5,35
000010405B		6	0,073	5,35
000010405C		6	0,073	5,35
000010405F		6	0,073	5,35
000010405H		6	0,073	5,35



With serrated edge for an easy removal of the dirt from the broom

**JOBBY** - plastic coloured dustpan with aluminium handle and black cover



REF.	NOTES	PCK	VOLUME (m³)	GROSS WEIGHT (kg)
000010105A		6	0,073	5,35
000010105B		6	0,073	5,35
000010105C		6	0,073	5,35
000010105F		6	0,073	5,35
000010105H		6	0,073	5,35



With serrated edge for an easy removal of the dirt from the broom

Broom with handle 80 cm for Jobby dustpan



REF.	NOTES	PCK	VOLUME (m³)	GROSS WEIGHT (kg)
0000SC01010		12	0,035	3,68

Broom with telescopic handle 65-110 cm for Jobby dustpan



REF.	NOTES	PCK	VOLUME (m³)	GROSS WEIGHT (kg)
0000SC01020		12	0,035	5,8

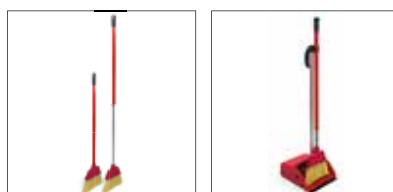



DUST MOPPING

DAMP MOPPING

**DUSTPANS**

INDUSTRIAL BROOMS

HOUSEHOLD ARTICLES

EQUIPMENT FOR WAX APPLICATION

PAD HOLDERS

SCRAPERS

FLOOR SQUEEGEES

## Metal dustpan with handle



REF.	NOTES	PCK	VOLUME (m³)	GROSS WEIGHT (kg)	SIZE (cm) ↓ ↓ ↓
0000VA01010		12	0,044	10,02	35x26x75

## VERDE - polypropylene broom with wooden handle 110 cm



REF.	NOTES	PCK	VOLUME (m³)	GROSS WEIGHT (kg)
9045		10	0,133	8,88

## POCKER - dustpan 15 L with 2 wheels ø 80 mm and ergonomic grip



REF.	NOTES	PCK	VOLUME (m³)	GROSS WEIGHT (kg)	SIZE (cm) ↓ ↓ ↓
000010100A	blue with yellow cover	4	0,149	8,4	20x32x91
000010100F	green with yellow cover	4	0,149	8,4	20x32x91



## POCKER-4 - dustpan 15 L with 4 wheels ø 80 mm and ergonomic grip



REF.	NOTES	PCK	VOLUME (m³)	GROSS WEIGHT (kg)	SIZE (cm) ↓ ↓ ↓
000020100A	blue with yellow cover	4	0,214	9,89	20x32x91
000020100F	green with yellow cover	4	0,214	9,89	20x32x91



## Plastic dustpan with rubber profile and grip



REF.	NOTES	PCK	VOLUME (m³)	GROSS WEIGHT (kg)
0000PA01020U		12	0,063	2,69



DUST MOPPING

DAMP MOPPING

**DUSTPANS****INDUSTRIAL BROOMS**

HOUSEHOLD ARTICLES

EQUIPMENT FOR WAX APPLICATION

PAD HOLDERS

SCRAPERS

FLOOR SQUEEGEES

## Nipper for safe waste pick-up

REF.	NOTES	PCK	VOLUME (m <sup>3</sup> )	GROSS WEIGHT (kg)	SIZE (cm) ↓ ↓ ↓
9122		10	0,045	4,24	100
9121		10	0,018	2,44	40



Ideal for the safety collection of syringes, broken glass and similar

## Brooms for outdoor use

### STREET - polypropylene broom, no handle

REF.	NOTES	PCK	VOLUME (m <sup>3</sup> )	GROSS WEIGHT (kg)
9039	Weight: 700 gr	10	0,042	7,01



Fitting handle art. 1070

## Food-grade items

### Blue PBT industrial broom

REF.	NOTES	PCK	VOLUME (m <sup>3</sup> )	GROSS WEIGHT (kg)	SIZE (cm) ↓ ↓ ↓
0000G11001A		10	0,024	3,99	30
0000G11006A		10	0,029	6,96	45



In compliance with the H.A.C.C.P. rules - Autoclavable up to 120° C - It can be used with handles art. 0000AM30010U and art. 0000PM3000D - Suitable for refrigerated environments.

### Food-grade blue BPT oval broom

**NEW**

REF.	NOTES	PCK	GROSS WEIGHT (kg)	SIZE (cm) ↓ ↓ ↓
0000G11009A	Italian screw thread	6	2,11	23x14x14



In compliance with the H.A.C.C.P. rules - Autoclavable up to 120° C - It can be used with handles art. 0000AM30010U and art. 0000PM3000D - Recommended for cleaning round containers, tanks, reservoirs and basins.





- DUST MOPPING
- DAMP MOPPING
- DUSTPANS
- INDUSTRIAL BROOMS
- HOUSEHOLD ARTICLES
- EQUIPMENT FOR WAX APPLICATION
- PAD HOLDERS
- SCRAPERS
- FLOOR SQUEEGEES

## Food-grade blue BPT brush

**NEW**

REF.	NOTES	PCK	VOLUME (m³)	GROSS WEIGHT (kg)	SIZE (cm) ↓ ↓ ↓
0000GI2000A		6	0,013	2,29	26x12x6



In compliance with the H.A.C.C.P. rules - Autoclavable up to 120° C - Recommended for cleaning containers, work benches, cutters and machine components

## Food-grade blue BPT brush with handle

**NEW**

REF.	NOTES	PCK	VOLUME (m³)	GROSS WEIGHT (kg)	SIZE (cm) ↓ ↓ ↓
0000GI2001A	maxi	6	0,013	1,36	25x9x10
0000GI2002A	mini	12	0,01	1,45	25,5x5,5x8



In compliance with the H.A.C.C.P. rules - Autoclavable up to 120° C - Recommended for cleaning dishes, pots and tools of various kinds

## Food-grade white brush with handle

**NEW**

REF.	NOTES	PCK	VOLUME (m³)	GROSS WEIGHT (kg)	SIZE (cm) ↓ ↓ ↓
0000GI2003D		12	0,015	2,3	38x7,5x6,5



In compliance with the H.A.C.C.P. rules - Autoclavable up to 120° C - Recommended for cleaning containers, work benches, graters and cutters

## Nylon and coconut fibers brooms

### Industrial broom, stiff nylon with thread

REF.	NOTES	PCK	VOLUME (m³)	GROSS WEIGHT (kg)	SIZE (cm) ↓ ↓ ↓
9020		10	0,049	4,57	33



Fitting handle art. 0000LM30023

### Industrial broom, stiff nylon

REF.	NOTES	PCK	VOLUME (m³)	GROSS WEIGHT (kg)	SIZE (cm) ↓ ↓ ↓
9021		10	0,064	11,54	60
9025		6	0,083	13,79	100



Fitting handle art. 1057



# Floor care and dusting

DUST MOPPING

DAMP MOPPING

DUSTPANS

**INDUSTRIAL BROOMS****HOUSEHOLD ARTICLES**

EQUIPMENT FOR WAX APPLICATION

PAD HOLDERS

SCRAPERS

FLOOR SQUEEGEES

## Industrial broom, coconut fibers



REF.	NOTES	PCK	VOLUME (m <sup>3</sup> )	GROSS WEIGHT (kg)	SIZE (cm) ↓ ↓ ↓
9022		6	0,049	7,19	60
9026		6	0,083	11,56	100

Fitting handle art. 1057

## Industrial broom, soft nylon



REF.	NOTES	PCK	VOLUME (m <sup>3</sup> )	GROSS WEIGHT (kg)	SIZE (cm) ↓ ↓ ↓
9028		6	0,049	8,13	60
9029		6	0,083	12,74	100

Fitting handle art. 1057

## Brooms for household use

### LIANA - coloured acrylic broom



REF.	NOTES	PCK	VOLUME (m <sup>3</sup> )	GROSS WEIGHT (kg)
1008		50	0,079	12,48

### LIANA - acrylic broom with flexible handle



REF.	NOTES	PCK	VOLUME (m <sup>3</sup> )	GROSS WEIGHT (kg)
1012		6	0,031	3,79

### BRILLO - cloth holder for pre-soaked cloths with a set of 25 cloths 25x42 cm



REF.	NOTES	PCK	VOLUME (m <sup>3</sup> )	GROSS WEIGHT (kg)
5253A	pck. hang-up bag	10	0,043	3,44

### Pre-soaked cloths for Brillo



REF.	NOTES	PCK	VOLUME (m <sup>3</sup> )	GROSS WEIGHT (kg)
5248	pck. hang-up bag with 25 pcs	20	0,019	1,9



DUST MOPPING

DAMP MOPPING

DUSTPANS

INDUSTRIAL BROOMS

HOUSEHOLD ARTICLES

EQUIPMENT FOR WAX APPLICATION

PAD HOLDERS

SCRAPERS

FLOOR SQUEEGEES

## GIADA - plastic broom



REF.	NOTES	PCK	VOLUME (m <sup>3</sup> )	GROSS WEIGHT (kg)
9041		10	0,032	3,2

Fitting handle art. 0000LM30023 and art. 1059

## PVC broom with bumpers

**NEW**



REF.	NOTES	PCK	VOLUME (m <sup>3</sup> )	GROSS WEIGHT (kg)	SIZE (cm) ↓ ↓ ↓
9044		12	0,029	4,5	34x8x11

Fitting handle art. 0000LM30023 and art. 1059

## Wax applicator tools

### SLIDER - wax applicator with tank 1,5 L and sleeve 40 cm



REF.	NOTES	PCK	VOLUME (m <sup>3</sup> )	GROSS WEIGHT (kg)
8150		1	0,033	2,79



### UNILAV SIDE GRIP - tool for wax application with refilling bottle 1 L, Rapido cloth holder and Smart-Fur microfiber mop



REF.	NOTES	PCK	VOLUME (m <sup>3</sup> )	GROSS WEIGHT (kg)
0002TD1147A		1	0,038	2,08



DUST MOPPING

DAMP MOPPING

DUSTPANS

INDUSTRIAL  
BROOMSHOUSEHOLD  
ARTICLESEQUIPMENT FOR  
WAX APPLICATION

PAD HOLDERS

SCRAPERS

FLOOR  
SQUEEGEES

## Mops for wax application





### RAPIDO - plastic holder with back fixing hooks

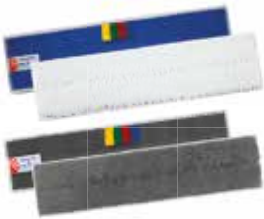

REF.	NOTES	PCK	VOLUME (m³)	GROSS WEIGHT (kg)	SIZE (cm) ↓ ↓ ↓
0000TA0001A		10	0,019	2,73	40

### SMART-FUR - microfiber mop with backing for velcro system and colour-coded tags



REF.	NOTES	PCK	VOLUME (m³)	GROSS WEIGHT (kg)	SIZE (cm) ↓ ↓ ↓
00PN0403A00		25	0,015	1,69	40
00PN0403A00E		25	0,015	1,69	40
00PN0603A00		20	0,015	1,79	60
00PN0603A00E		20	0,015	1,79	60

Ideal for all smooth surfaces with a medium-low dirt level

### Jointed support with sleeve for wax application



REF.	NOTES	PCK	VOLUME (m³)	GROSS WEIGHT (kg)	SIZE (cm) ↓ ↓ ↓
9400		12	0,024	2,78	35
9100		12	0,03	2,84	40

### Jointed support for wax application



REF.	NOTES	PCK	VOLUME (m³)	GROSS WEIGHT (kg)	SIZE (cm) ↓ ↓ ↓
9401		12	0,011	1,82	35
9147		12	0,011	1,75	40

### Polyester sleeve for wax application



REF.	NOTES	PCK	VOLUME (m³)	GROSS WEIGHT (kg)	SIZE (cm) ↓ ↓ ↓
9402		25	0,024	1,98	35
9109		25	0,03	2,24	40



- DUST MOPPING
- DAMP MOPPING
- DUSTPANS
- INDUSTRIAL BROOMS
- HOUSEHOLD ARTICLES
- EQUIPMENT FOR WAX APPLICATION
- PAD HOLDERS
- SCRAPERS
- FLOOR SQUEEGEES

## Systems for wax application

Bucket trolley for wax application complete with pushing handle, plastic sieve and sleeve 40 cm



REF.	NOTES	PCK	VOLUME (m³)	GROSS WEIGHT (kg)	SIZE (cm) ↓ ↓ ↓
9200/PRO		1	0,093	5,12	30x74x88

Plastic bucket 20 L with plastic handle



REF.	NOTES	PCK	VOLUME (m³)	GROSS WEIGHT (kg)	SIZE (cm) ↓ ↓ ↓
0000SE1222A		10	0,169	12,19	55x24x27
0000SE1222B		10	0,169	12,19	55x24x27
0000SE1222U		10	0,169	12,19	55x24x27

Plastic sieve fitting bucket trolley for wax application / window cleaning



REF.	PCK	VOLUME (m³)	GROSS WEIGHT (kg)	SIZE (cm) ↓ ↓ ↓
9206A	30	0,105	7,35	53x8x10

For window washer 35 and 40 cm

**TWIN** - plastic bucket 2x10 L with two plastic handles



REF.	NOTES	PCK	VOLUME (m³)	GROSS WEIGHT (kg)	SIZE (cm) ↓ ↓ ↓
7914A		5	0,132	8,79	45x36x26



Fitting window washer 35 cm

Plastic sieve for Twin bucket



REF.	NOTES
21021A	



# Floor care and dusting

DUST MOPPING

DAMP MOPPING

DUSTPANS

INDUSTRIAL  
BROOMSHOUSEHOLD  
ARTICLESEQUIPMENT FOR  
WAX APPLICATION



PAD HOLDERS

SCRAPERS

FLOOR  
SQUEEGEES

## Plastic bucket 28 L with plastic handle



REF.	NOTES	SIZE (cm) ↓ ↓ ↓
0000SE1428A		52x32x27
0000SE1428B		52x32x27



## Pierced plastic sieve for bucket 28 L



REF.	NOTES
P1190043A	

## Plastic cover for bucket 28 L

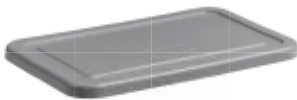

REF.	NOTES	SIZE (cm) ↓ ↓ ↓
0000CP1128U		53x33x2,8

## Wheel ø 50 mm



REF.	NOTES
7949	for King, Spider, Ro-cket Wheels, Prisma, Twin, Top-Down®, Pick-Up, Trend and art. 0000SE1428

## Mop holders and pads

### Manual pad holder



REF.	NOTES	PCK	VOLUME (m³)	GROSS WEIGHT (kg)	SIZE (cm) ↓ ↓ ↓
5228A		12	0,014	3,09	23x10

### Jointed pad holder



REF.	NOTES	PCK	VOLUME (m³)	GROSS WEIGHT (kg)	SIZE (cm) ↓ ↓ ↓
5229A		12	0,014	2,45	23,5x10



DUST MOPPING

DAMP MOPPING

DUSTPANS

 INDUSTRIAL  
BROOMS

 HOUSEHOLD  
ARTICLES

 EQUIPMENT FOR  
WAX APPLICATION

**PAD HOLDERS**
**SCRAPERS**

 FLOOR  
SQUEEGEES

## Jointed pad holder with Lock System



REF.	NOTES	PCK	VOLUME (m³)	GROSS WEIGHT (kg)	SIZE (cm) ↓ ↓ ↓
5329A		12	0,019	2,81	23,5x10

## Abrasive pad



REF.	NOTES	PCK	VOLUME (m²)	GROSS WEIGHT (kg)	SIZE (cm) ↓ ↓ ↓
5222		12	0,011	0,45	12x25
5222F		12	0,011	0,84	12x25
5222G		12	0,011	0,84	12x25
5222H		12	0,011	0,84	12x25

## Scrapers and blades

### Floor scraper with plastic grip



REF.	NOTES	PCK	VOLUME (m³)	GROSS WEIGHT (kg)	SIZE (cm) ↓ ↓ ↓
9151		25	0,019	4,29	22

### Floor scraper with metal handle



REF.	NOTES	PCK	VOLUME (m³)	GROSS WEIGHT (kg)	SIZE (cm) ↓ ↓ ↓
9152		25	0,019	6,89	25
9153		10	0,033	8,47	120

### Blades for floor scraper



REF.	NOTES
9154	1 pc art. 9154 = 250 blades



DUST MOPPING

DAMP MOPPING

DUSTPANS

INDUSTRIAL ROOMS

HOUSEHOLD ARTICLES

EQUIPMENT FOR WAX APPLICATION

PAD HOLDERS

SCRAPERS

**FLOOR SQUEEGEES**

Our **plastic floor squeegees** are composed of a polypropylene support and a single rubber blade and guarantee the highest hygiene and a very simple cleaning. Ideal for the food industries since **they are suitable for the contact with foodstuffs** according to European standards. Autoclavable up to 120° C, recommended also for hospitals.



The single rubber blade perfectly adheres to several kinds of floors and is resistant to low concentration acids and oil.

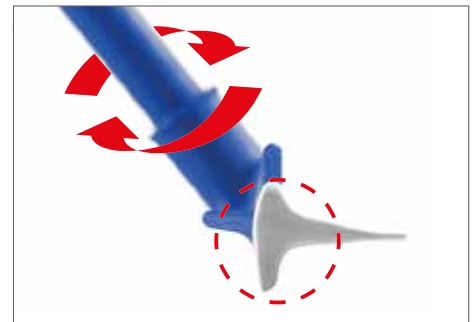

This floor squeegee can be used also as a scraper to eliminate possible deposits on the floor.

## Plastic floor squeegees

Autoclavable floor squeegee with soft rubber blade for food industry, with Italian screw and coloured support



REF.	NOTES	PCK	VOLUME (m³)	GROSS WEIGHT (kg)	SIZE (cm)
00009312DD		10	0,025	2,74	45
00009313AD		10	0,02	3,9	55
00009313BD		10	0,02	3,9	55
00009313CD		10	0,02	3,9	55
00009313DD		10	0,02	3,9	55
00009313FD		10	0,02	3,9	55
00009314DD		10	0,046	4,13	75



Products ideal for the contact with foodstuffs according to the European law (Directive CE 1935/2004 e Regulations CE No. 10/2011)





DUST MOPPING

DAMP MOPPING

DUSTPANS

INDUSTRIAL BROOMS

HOUSEHOLD ARTICLES

EQUIPMENT FOR WAX APPLICATION

PAD HOLDERS

SCRAPERS

**FLOOR SQUEEGES**

Plastic floor squeegee, with white rubber blade and coloured support

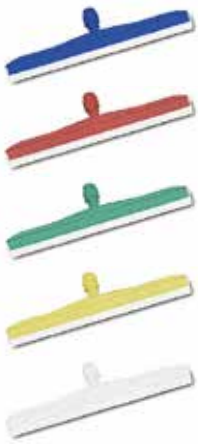

REF.	NOTES	PCK	VOLUME (m³)	GROSS WEIGHT (kg)	SIZE (cm) ↓ ↓ ↓
00009011AD		12	0,023	2,21	35
00009012AD		12	0,028	2,79	45
00009012BD		12	0,028	2,57	45
00009012CD		12	0,028	2,57	45
00009012DD		12	0,028	2,57	45
00009012FD		12	0,028	2,57	45
00009013AD		12	0,035	3,21	55
00009013BD		12	0,035	2,77	55
00009013CD		12	0,035	2,77	55
00009013DD		12	0,035	2,77	55
00009013FD		12	0,035	2,77	55
00009014AD		12	0,046	4,3	75
00009014BD		12	0,046	3,77	75
00009014CD		12	0,046	3,77	75
00009014DD		12	0,046	3,77	75
00009014FD		12	0,046	3,77	75

Plastic floor squeegee with black rubber



REF.	NOTES	PCK	VOLUME (m³)	GROSS WEIGHT (kg)	SIZE (cm) ↓ ↓ ↓
00009011AH		12	0,023	2,21	35
00009012AH		12	0,028	2,69	45
00009013AH		12	0,035	3,21	55
00009014AH		12	0,046	4,23	75

## Metal floor squeegee

Metal floor squeegee with black rubber



REF.	NOTES	PCK	VOLUME (m³)	GROSS WEIGHT (kg)	SIZE (cm) ↓ ↓ ↓
9007		12	0,028	5,09	45
9008		12	0,035	5,65	55
9009		12	0,046	6,92	75



# Floor cleaning

- Tab system
- Pocket system
- Pocket-tab system
- Duo Face system
- Velcro system
- Tools with tank
- Mop system





TAB SYSTEM

POCKET SYSTEM

POCKET-TAB SYSTEM

DUO FACE SYSTEM

VELCRO SYSTEM

TOOLS WITH TANK

MOP SYSTEM

## FILMOP YARNS



### COTTON

70% Cotton - 30% Polyester

Natural highly absorbing fiber that keeps dirt, releasing it only during the washing of the mop. Ideal for all inside floors with a medium degree of dirt.



### POLYESTER-COTTON

70% Polyester - 30% Cotton

The combination of cotton, a natural fiber with a high absorbing level, and polyester, a synthetic fiber very strong and resistant to washings, guarantees a perfect running of the mop on the floor. Ideal for all inside floors with a medium degree of dirt.



### MICROFIBER

80% Polyester - 20% Polyamide

**Microfiber** is a synthetic fiber which penetrates deep into the grooves and pores of floors, absorbing the removed dirt and retaining it till mop washing. Ideal for all inside floors with a medium degree of dirt.



### RAPIDO

80% Polyester - 20% Polyamide

The **microfiber** easily slides on the surfaces, efficiently removing all dirt. The high level of absorption ensures excellent cleaning properties, while the resistance to washing guarantees long life. Ideal for all inside floors with a medium-high degree of dirt.

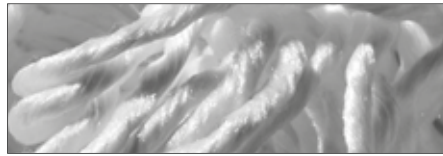

### RAPIDO SUPER

80% Polyester - 20% Polyamide

**Ultra-microfiber** guarantees excellent cleaning results, higher efficiency and smoothness thanks to its fibers which penetrate into the grooves and pores of floors. Ideal for all inside floors with a medium-high degree of dirt.



### MICROFIBER-COTTON-POLYESTER

70% Polyester - 30% Cotton

**Microfiber** better releases the micro-particles of dirt, cotton improves the absorbing capacity of the mop, covering more washable square meter, while polyester allows an easier running of the mop on the floors. Ideal for all inside floors with a medium-high degree of dirt.



### MICRO-ACTIVA

85% Polyester - 15% Polyamide

Specific variety of **microfiber** ideal for dust mopping thanks to the electrostatic properties of its fiber, washing and pre-soaking. Thanks to its internal microfiber, it has a high absorbing capacity. Ideal for the washing of smooth surfaces with a medium degree of dirt.

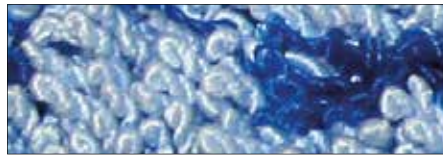

### PULI-SCRUB

50% Polyester - 20% Polyamide - 30% Polypropylene

**Microfiber** with polypropylene inserts which ensure a great removal action of dirt while offering excellent smoothness. Ideal for non-slip floors with a medium-high level of dirt.

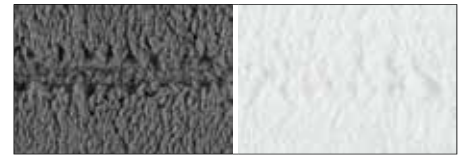

### SMART-FUR

100% Polyester

Thanks to its very thin fibers, **microfiber** acts physically and mechanically on particles of dirt removing and trapping them in its fibers. Ideal for dust mopping thanks to the high electrostatic power of its fibers and for spray cleaning.

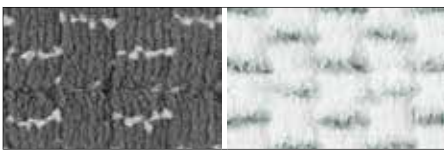

### ACTIVE-FUR

90% Polyester - 10% Polyamide

**Microfiber** with nylon inserts for a lower mop friction and a better dirt collection. Ideal for the washing of smooth surfaces with a medium degree of dirt.

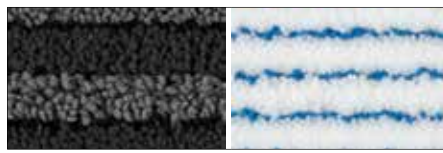

### SKILL-FUR

80% Polyester - 20% Polyamide

**Microfiber** with stripes. Its special composition provides a perfect balance between cleaning power and mop friction. Ideal for the washing of smooth surfaces with a medium degree of dirt.

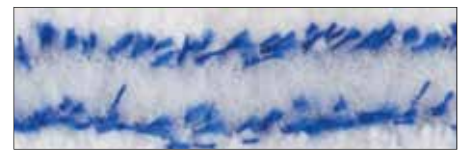

### ENERGY-FUR

87% Polyester - 13% Polyamide

White **Microfiber** with blue stripes of brushed fiber with intensive action. Polyester, thanks to its hooked micro-structure, generates non abrasive mechanical action of dirt removal. Polyamide, due to its high absorbing power, retains water and the dirt removed. Ideal for the washing of smooth surfaces with a medium degree of dirt.





TAB SYSTEM

POCKET SYSTEM

POCKET-TAB SYSTEM

DUO FACE SYSTEM

VELCRO SYSTEM

TOOLS WITH TANK

MOP SYSTEM



### PULI-BRUSH

50% Polypropylene - 40% Polyester - 10% Polyamide

The polypropylene inserts quickly loosen even the most stubborn dirt, which is then captured by the **microfibre**, leaving a perfectly clean surface. Ideal for medium to very dirty non-slip floors.

Ideal for the washing of smooth surfaces with a medium degree of dirt.



### ANTI BACTERIAL MICROFIBER

85% Polyester - 15% Polyamide

**AB-Plus microfibre**, thanks to a special anti-bacterial treatment of its fibers, is ideal to reduce the bacterial growth and risks of cross-contamination. It removes up to 99,98% of bacteria and fungi and it reduces growth of them thanks to the electrostatic action.

Ideal for the washing of smooth surfaces with a medium degree of dirt.



*Please, refer to page 11 for the washing instructions.*

## Tuft Line: special tufted mop for all surfaces

### High absorbency, lower friction and longer life

The Tuft line is composed by two kinds of mops: **Mastertuft** and **Dreituft**.

Thanks to the special closed-ring Tufting system, the yarn remains firmly sewn to the mop backing, guaranteeing a longer life of the mop.

**Tuft flat mops** are ideal for cleaning with wet, damp and disinfection mopping systems; they are perfect for any kind of floor.

The special thickly interwoven fabric allows a better distribution of the chemical material on the fiber structure. Better absorbency, a good mop friction for a cleaning without any effort. Available with pockets and colour-coded tags.

### WASHABLE UP TO 95°C - WASHABLE OVER 300 TIMES!

### DREITUFT: ideal for heavily soiled surfaces and deep cleaning



Made of microfibre-cotton-polyester and available in the versions:

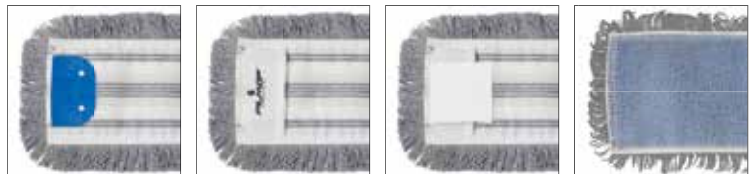

Flaps

Pockets

Pockets-flaps

Velcro system

### MASTERTUFT: ideal for normally soiled surfaces and frequent cleaning



Made of cotton-polyester and available in the versions:



Flaps

Pockets

Pockets-flaps

Velcro system



TAB SYSTEM

POCKET SYSTEM

POCKET-TAB SYSTEM

DUO FACE SYSTEM

VELCRO SYSTEM

TOOLS WITH TANK

MOP SYSTEM

Filmop is the first Italian company designing and producing an innovative floor flat mopping system, overcoming the traditional ones employing string mops.

Filmop has conceived a new mopping system based on a flat plastic mop holder, named "Telaio Speedy®", to increase the size of the cleaning tool mopping the floor with important advantages in terms of time and collection of dirt.

Moreover, Speedy mop holders are foldable allowing to wring the mop without dropping it from the mop holder.

All Filmop mop holders can be equipped with **Lock System** that improves the cleaning of walls and ceilings just locking and unlocking the joint simply pushing up and down the special device using one's foot.

**NEW**

## ErgoSwing ergonomic system

The Speedy® mop holder is available in the **ErgoSwing** version, for higher performance and lower effort.



Folded mop holder to wring the mop



Spin the mop holder and let it drop onto the floor to open it



**Unlocked joint:** floor cleaning



**Locked joint:** cleaning of walls and ceilings



Learn more about **ErgoSwing** in the handle section

## Speedy mop holders

### SPEEDY MOP HOLDER® - foldable plastic mop holder



REF.	NOTES	PCK	VOLUME (m³)	GROSS WEIGHT (kg)	SIZE (cm) ↓ ↓ ↓
00008116AB		10	0,024	5,8	40x11
8125AB		10	0,035	10,06	50x13

### SPEEDY MOP HOLDER® - foldable plastic mop holder with Lock System joint



REF.	NOTES	PCK	VOLUME (m³)	GROSS WEIGHT (kg)	SIZE (cm) ↓ ↓ ↓
00008316AB		10	0,024	6,1	40x11

### SPEEDY FRAME® - plastic folding frame with ErgoSwing fitting

**NEW**



REF.	NOTES	PCK	VOLUME (m³)	GROSS WEIGHT (kg)	SIZE (cm) ↓ ↓ ↓
00008916AB		10	0,028	6,45	40x11

Use with ErgoSwing system handle, code 0000AM3045



TAB SYSTEM

POCKET SYSTEM

POCKET-TAB SYSTEM

DUO FACE SYSTEM

VELCRO SYSTEM

TOOLS WITH TANK

MOP SYSTEM

## Speedy mops

Mop **SPEEDY** polyester and cotton, polyester backing, looped yarn, with flaps 2 holes

REF.	NOTES	PCK	VOLUME (m <sup>3</sup> )	GROSS WEIGHT (kg)	SIZE (cm) ↓ ↓ ↓
<b>8414</b>	for 40 x 11 cm mop holders	25	0,028	4,32	40x13
<b>8420</b>	for mop holders 50 x 13 cm	25	0,043	5,83	50x16



Mops with coloured borders available on request - Kindly contact our offices for the minimum order quantity

Mop **SPEEDY** polyester and cotton, polyester backing, looped yarn inside and cut yarn outside, with flaps 2 holes

REF.	NOTES	PCK	VOLUME (m <sup>3</sup> )	GROSS WEIGHT (kg)	SIZE (cm) ↓ ↓ ↓
<b>8414/M</b>	for 40 x 11 cm mop holders	25	0,028	4,32	40x13
<b>8420/M</b>	for mop holders 50 x 13 cm	25	0,043	6,3	50x16



Mop **SPEEDY** cotton, polyester backing, looped yarn, with flaps 2 holes

REF.	NOTES	PCK	VOLUME (m <sup>3</sup> )	GROSS WEIGHT (kg)	SIZE (cm) ↓ ↓ ↓
<b>0C08414</b>	for 40 x 11 cm mop holders	25	0,028	3,93	40x13
<b>0C08420</b>	for mop holders 50 x 13 cm	25	0,043	6,08	50x16



Mops with coloured borders available on request - Kindly contact our offices for the minimum order quantity

Mop **SPEEDY** cotton, polyester backing, looped yarn inside and cut yarn outside, with flaps 2 holes

REF.	NOTES	PCK	VOLUME (m <sup>3</sup> )	GROSS WEIGHT (kg)	SIZE (cm) ↓ ↓ ↓
<b>0C08414/M</b>	for 40 x 11 cm mop holders	25	0,028	3,93	40x13
<b>0C08420/M</b>	for mop holders 50 x 13 cm	25	0,043	6,08	50x16



Mops with coloured borders available on request - Kindly contact our offices for the minimum order quantity



**TAB SYSTEM**

POCKET SYSTEM

POCKET-TAB SYSTEM

DUO FACE SYSTEM

VELCRO SYSTEM

TOOLS WITH TANK

MOP SYSTEM

Mop **SPEEDY** polyester and cotton, polyester backing, looped yarn inside and cut yarn outside, with external flaps 2 holes



REF.	NOTES	PCK	VOLUME (m <sup>3</sup> )	GROSS WEIGHT (kg)	SIZE (cm) ↓ ↓ ↓
<b>8511/M</b>	for 40 x 11 cm mop holders	25	0,024	4,17	40x13
<b>8518/M</b>	for mop holders 50 x 13 cm	25	0,03	5,69	50x16

Mop **SPEEDY** polyester and cotton, polyester backing, looped yarn, with external flaps 2 holes



REF.	NOTES	PCK	VOLUME (m <sup>3</sup> )	GROSS WEIGHT (kg)	SIZE (cm) ↓ ↓ ↓
<b>8511</b>	for 40 x 11 cm mop holders	25	0,024	4,17	40x13

Mop **SPEEDY** cotton, polyester backing, looped yarn inside and cut yarn outside, with external flaps 2 holes



REF.	NOTES	PCK	VOLUME (m <sup>3</sup> )	GROSS WEIGHT (kg)	SIZE (cm) ↓ ↓ ↓
<b>0C08511/M</b>	for 40 x 11 cm mop holders	25	0,024	3,67	40x13

Mop **SPEEDY** cotton, polyester backing, looped yarn, with external flaps 2 holes



REF.	NOTES	PCK	VOLUME (m <sup>3</sup> )	GROSS WEIGHT (kg)	SIZE (cm) ↓ ↓ ↓
<b>0C08511</b>	for 40 x 11 cm mop holders	25	0,024	4,17	40x13

Mop **SPEEDY** microfiber, polyester backing, looped yarn, with flaps 2 holes



REF.	NOTES	PCK	VOLUME (m <sup>3</sup> )	GROSS WEIGHT (kg)	SIZE (cm) ↓ ↓ ↓
<b>0000121D</b>	for 40 x 11 cm mop holders	25	0,028	3,53	40x13
<b>0000611D</b>	for mop holders 50 x 13 cm	25	0,043	5,58	50x16

Ideal for any surface (especially the porous one) with a medium-high dirt level

Mop **SPEEDY** coloured microfiber, polyester backing, looped yarn, with flaps 2 holes



REF.	NOTES	PCK	VOLUME (m <sup>3</sup> )	GROSS WEIGHT (kg)	SIZE (cm) ↓ ↓ ↓
<b>0000121AA</b>		25	0,028	3,53	40x13
<b>0000121BB</b>		25	0,028	3,53	40x13
<b>0000121CC</b>		25	0,028	3,53	40x13
<b>0000121FF</b>		25	0,028	3,53	40x13

Ideal for any surface (especially the porous one) with a medium-high dirt level



**TAB SYSTEM**

POCKET SYSTEM

POCKET-TAB SYSTEM

DUO FACE SYSTEM

VELCRO SYSTEM

TOOLS WITH TANK

MOP SYSTEM

Mop **SPEEDY** microfiber, polyester backing, looped yarn, with external flaps 2 holes



REF.	NOTES	PCK	VOLUME (m <sup>3</sup> )	GROSS WEIGHT (kg)	SIZE (cm) ↓ ↓ ↓
<b>8516</b>	for 40 x 11 cm mop holders	25	0,024	3,67	40x13

Ideal for all inside floors (especially the porous ones)

Mop **SPEEDY** coloured microfiber, polyester backing, looped yarn, with external flaps 2 holes



REF.	NOTES	PCK	VOLUME (m <sup>3</sup> )	GROSS WEIGHT (kg)	SIZE (cm) ↓ ↓ ↓
<b>8516A</b>	for 40 x 11 cm mop holders	25	0,024	3,67	40x13
<b>8516B</b>	for 40 x 11 cm mop holders	25	0,024	3,67	40x13
<b>8516C</b>	for 40 x 11 cm mop holders	25	0,024	3,67	40x13
<b>8516F</b>	for 40 x 11 cm mop holders	25	0,024	3,67	40x13

Mop **SPEEDY** microfiber, cotton and polyester, polyester backing, looped yarn, with flaps 2 holes



REF.	NOTES	PCK	VOLUME (m <sup>3</sup> )	GROSS WEIGHT (kg)	SIZE (cm) ↓ ↓ ↓
<b>0000122D</b>	for 40 x 11 cm mop holders	25	0,028	3,67	40x13
<b>0000612D</b>	for mop holders 50 x 13 cm	25	0,043	5,58	50x16



Mops with coloured borders available on request - Kindly contact our offices for the minimum order quantity

Mop **SPEEDY** microfiber, cotton and polyester, polyester backing, looped yarn, with external flaps 2 holes

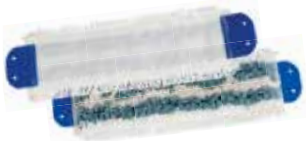

REF.	NOTES	PCK	VOLUME (m <sup>3</sup> )	GROSS WEIGHT (kg)	SIZE (cm) ↓ ↓ ↓
<b>0000FS0122D</b>	for 40 x 11 cm mop holders	25	0,024	3,42	40x13

**SPEEDY MASTERTUFT** - cotton mop, polyester backing, tufting, cut outside, with 2-hole flaps

**NEW**



REF.	NOTES	PCK	VOLUME (m <sup>3</sup> )	GROSS WEIGHT (kg)	SIZE (cm) ↓ ↓ ↓
<b>00TM0401C00</b>	for 40 x 11 cm mop holders	25	0,028	4,43	40x13
<b>00TM0501C00</b>	for mop holders 50 x 13 cm	25	0,043	5,58	50x16

Ideal for a medium level of dirt and frequent cleaning

**SPEEDY DREITUFT** - microfiber, cotton and polyester mop, polyester backing, tufting, cut outside, with 2-hole flaps

**NEW**



REF.	NOTES	PCK	VOLUME (m <sup>3</sup> )	GROSS WEIGHT (kg)	SIZE (cm) ↓ ↓ ↓
<b>00TM0414C00</b>	for 40 x 11 cm mop holders	25	0,028	4,68	40x13
<b>00TM0514C00</b>	for mop holders 50 x 13 cm	25	-	0	50x16

Ideal for heavily soiled surfaces and deep cleaning





**TAB SYSTEM**

POCKET SYSTEM

POCKET-TAB SYSTEM

DUO FACE SYSTEM

VELCRO SYSTEM

TOOLS WITH TANK

MOP SYSTEM

**SPEEDY MICRO-ACTIVA** microfibre mop, polyester backing, with 2-hole flaps and colour-coded tag



REF.	NOTES	PCK	VOLUME (m <sup>3</sup> )	GROSS WEIGHT (kg)	SIZE (cm) ↓ ↓ ↓
0000PN07012	for 40 x 11 cm mop holders	25	0,015	2,56	40x13
0000PN07032	for mop holders 50 x 13 cm	25	0,03	3,64	50x16

Ideal for all smooth surfaces with a medium dirt level

**SPEEDY PULI-SCRUB** microfibre and polypropylene mop, polyester backing, with 2-hole flaps and colour-coded tag



REF.	NOTES	PCK	VOLUME (m <sup>3</sup> )	GROSS WEIGHT (kg)	SIZE (cm) ↓ ↓ ↓
0000PN07011	for 40 x 11 cm mop holders	25	0,015	3,14	40x13

Ideal for all rough surfaces with a medium-high dirt level- !s|\_Ideal also to remove stubborn dirt and limestone

**SPEEDY PULI-BRUSH** microfibre and polypropylene mop, polyester backing, with 2-hole flaps and colour-coded tag

**NEW**



REF.	NOTES	PCK	VOLUME (m <sup>3</sup> )	GROSS WEIGHT (kg)	SIZE (cm) ↓ ↓ ↓
00PN0418C00A	for 40 x 11 cm mop holders	25	0,019	3,71	40x13
00PN0418C00B	for 40x11 cm mop holder	25	0,019	3,71	40x13

Ideal for all rough surfaces with a medium-high dirt level- !s|\_Ideal also to remove stubborn dirt and limestone

**SPEEDY SMART-FUR** microfibre mop, polyester backing, 2-hole flaps and colour-coded tags



REF.	NOTES	PCK	VOLUME (m <sup>3</sup> )	GROSS WEIGHT (kg)	SIZE (cm) ↓ ↓ ↓
00PN0403C00		50	0,056	5,88	40x13
00PN0403C00E		50	0,056	5,88	40x13

Ideal for all smooth surfaces with a medium-low dirt level

**SPEEDY ACTIVE-FUR** microfibre mop with nylon inserts, polyester backing, 2-hole flaps and colour-coded tags



REF.	NOTES	PCK	VOLUME (m <sup>3</sup> )	GROSS WEIGHT (kg)	SIZE (cm) ↓ ↓ ↓
00PN0406C00		50	0,056	6,08	40x13
00PN0406C00E		25	0,025	2,65	40x13

Ideal for all smooth surfaces with a medium dirt level



**TAB SYSTEM**

POCKET SYSTEM

POCKET-TAB SYSTEM

DUO FACE SYSTEM

VELCRO SYSTEM

TOOLS WITH TANK

MOP SYSTEM

**SPEEDY SKILL-FUR** striped microfiber mop, polyester backing, 2-hole flaps and colour-coded tags



REF.	NOTES	PCK	VOLUME (m³)	GROSS WEIGHT (kg)	SIZE (cm) ↓ ↓ ↓
00PN0413C00		25	0,025	2,4	40x13
00PN0413C00E		50	0,056	5,18	40x13

Ideal for all smooth or rough surfaces with a medium dirt level

**SPEEDY ENERGY-FUR** white microfiber mop with blue stripes and abrasive, polyester backing, 2-hole flaps and colour-coded tags



REF.	NOTES	PCK	VOLUME (m³)	GROSS WEIGHT (kg)	SIZE (cm) ↓ ↓ ↓
00PN0411C00		50	0,056	5,68	40x13

Ideal for all smooth surfaces with a medium dirt level

## Click mop holder

**CLICK** - mop holder with buttons and joint



REF.	NOTES	PCK	VOLUME (m³)	GROSS WEIGHT (kg)	SIZE (cm) ↓ ↓ ↓
5544		15	0,035	4,54	44

## Mops for Click mop holder

Polyester and cotton mop, polyester backing, looped yarn, with flaps fitting Click mop holder



REF.	NOTES	PCK	VOLUME (m³)	GROSS WEIGHT (kg)	SIZE (cm) ↓ ↓ ↓
8512		25	0,024	3,67	44

Cotton mop, polyester backing, looped yarn, with flaps fitting Click mop holder



REF.	NOTES	PCK	VOLUME (m³)	GROSS WEIGHT (kg)	SIZE (cm) ↓ ↓ ↓
0C08512		25	0,024	3,67	44



TAB SYSTEM

**POCKET SYSTEM**

POCKET-TAB SYSTEM

DUO FACE SYSTEM

VELCRO SYSTEM

TOOLS WITH TANK

MOP SYSTEM

As regards the **disinfection with pocket mop system**, Filmop proposes a range of plastic foldable mop holders in different sizes, including **UNIKO** mop holder.

Thanks to the special fixing system of the mop to the frame, Uniko saves the operator from bending continuously to fix and drop the mop, avoiding the direct contact of the hands with the dirty mops. Uniko mop holder offers several advantages, such as less fatigue and less effort, ergonomics, utmost hygiene and better cleaning results.

All Filmop mop holders can be equipped with **Lock System** that improves the cleaning of walls and ceilings just locking and unlocking the joint simply pushing up and down the special device using one's foot.

**NEW**

## ErgoSwing ergonomic system

The Uniko mop holder is available in the **ErgoSwing** version, for higher performance and lower effort.

### HOW TO USE IT



Insert the mop holder into the pre-soaked pocket mop



Start mopping the floor.



**Unlocked joint:** floor cleaning



**Locked joint:** cleaning of walls and ceilings



Learn more about **ErgoSwing** in the handle section

### HOW TO REMOVE THE MOP



Open the mop holder by pushing the red foot-operated button



Drop the mop pushing the fixing clamp and throw it directly into the waste bag

## Mop holders for pocket mop

**UNIKO** - foldable plastic mop holder with mop fixing clip



REF.	NOTES	PCK	VOLUME (m³)	GROSS WEIGHT (kg)	SIZE (cm) ↓ ↓ ↓
0000TD0020AB		10	0,024	5,39	40x11
0000TD0010AB		10	0,035	9,14	50x13

**UNIKO** - foldable plastic mop holder with mop fixing clip and Lock System



REF.	NOTES	PCK	VOLUME (m³)	GROSS WEIGHT (kg)	SIZE (cm) ↓ ↓ ↓
0000TD0320AB		10	0,024	5,69	40x11
0000TD0310AB		10	0,035	9,14	50x13

**UNIKO** - plastic folding mop holder with mop head hook and ErgoSwing joint

**NEW**



REF.	NOTES	PCK	VOLUME (m³)	GROSS WEIGHT (kg)	SIZE (cm) ↓ ↓ ↓
0000TD0920AB		10	0,028	6,05	40x11
0000TD0910AB		10	-	9,08	50x13

Use with ErgoSwing system handle, code 0000AM3045



TAB SYSTEM

**POCKET SYSTEM**

POCKET-TAB SYSTEM

DUO FACE SYSTEM

VELCRO SYSTEM

TOOLS WITH TANK

MOP SYSTEM

## Foldable plastic mop holder



REF.	NOTES	PCK	VOLUME (m³)	GROSS WEIGHT (kg)	SIZE (cm) ↓ ↓ ↓
8115U	completely grey	10	0,019	4,66	42x9
8132AB		10	0,024	3,93	40x11
8119AB		10	0,028	7,37	40x13
8130AB		10	0,035	6	50x13

## Plastic folding mop holder with ErgoSwing

**NEW**



REF.	NOTES	PCK	VOLUME (m³)	GROSS WEIGHT (kg)	SIZE (cm) ↓ ↓ ↓
8932AB		10	0,023	0,39	40x11
8930AB		10	0,035	0,54	50x13

Use with ErgoSwing system handle, code 0000AM3045

## Pocket mops

### Polyester and cotton pocket mop, polyester backing, looped yarn



REF.	NOTES	PCK	VOLUME (m³)	GROSS WEIGHT (kg)	SIZE (cm) ↓ ↓ ↓
0000FD2401D	for 40 x 11 cm mop holders	25	0,028	4,82	40x13
8422	for mop holder 40x13 cm	25	0,028	5,07	40x16
8423	for mop holders 50 x 13 cm	25	0,043	6,58	50x16



Mops with coloured borders available on request - Kindly contact our offices for the minimum order quantity

### Polyester and cotton pocket mop, polyester backing, looped yarn inside and cut yarn outside



REF.	NOTES	PCK	VOLUME (m³)	GROSS WEIGHT (kg)	SIZE (cm) ↓ ↓ ↓
0000FD2402D	for 40 x 11 cm mop holders	25	0,028	4,68	40x13
8422/M	for mop holder 40x13 cm	25	0,028	5,07	40x16
8423/M	for mop holders 50 x 13 cm	25	0,043	6,58	50x16



Mops with coloured borders available on request - Kindly contact our offices for the minimum order quantity



TAB SYSTEM

**POCKET SYSTEM**

POCKET-TAB SYSTEM

DUO FACE SYSTEM

VELCRO SYSTEM

TOOLS WITH TANK

MOP SYSTEM

FLOOR  
CLEANING

Cotton pocket mop, polyester backing, looped yarn



REF.	NOTES	PCK	VOLUME (m³)	GROSS WEIGHT (kg)	SIZE (cm) ↓ ↓ ↓
0000FD1401D	for 40 x 11 cm mop holders	25	0,028	4,18	40x13
0000FD0501D	for mop holders 50 x 13 cm	25	0,043	6,08	50x16



Mops with coloured borders available on request - Kindly contact our offices for the minimum order quantity

Cotton pocket mop, polyester backing, looped yarn inside and cut yarn outside



REF.	NOTES	PCK	VOLUME (m³)	GROSS WEIGHT (kg)	SIZE (cm) ↓ ↓ ↓
0000FD1402D	for 40 x 11 cm mop holders	25	0,028	4,18	40x13
0000FD0502D	for mop holders 50 x 13 cm	25	0,043	6,08	50x16



Mops with coloured borders available on request - Kindly contact our offices for the minimum order quantity

Microfiber pocket mop, polyester backing, looped yarn



REF.	NOTES	PCK	VOLUME (m³)	GROSS WEIGHT (kg)	SIZE (cm) ↓ ↓ ↓
00003111D	for 40 x 11 cm mop holders	25	0,028	4,43	40x13
00005111D	for mop holders 50 x 13 cm	25	0,043	5,58	50x16

Ideal for any surface (especially the porous one) with a medium-high dirt level

Coloured microfiber pocket mop, polyester backing, looped yarn



REF.	NOTES	PCK	VOLUME (m³)	GROSS WEIGHT (kg)	SIZE (cm) ↓ ↓ ↓
00003111AA	for 40 x 11 cm mop holders	25	0,028	4,68	40x13
00003111BB	for 40 x 11 cm mop holders	25	0,028	4,68	40x13
00003111CC	for 40 x 11 cm mop holders	25	0,028	4,68	40x13
00003111FF	for 40 x 11 cm mop holders	25	0,028	4,68	40x13

Microfiber-cotton-polyester pocket mop, polyester backing, looped yarn



REF.	NOTES	PCK	VOLUME (m³)	GROSS WEIGHT (kg)	SIZE (cm) ↓ ↓ ↓
0000312D	for 40 x 11 cm mop holders	25	0,028	4,32	40x13
0000512D	for mop holders 50 x 13 cm	25	0,043	6,08	50x16



Mops with coloured borders available on request - Kindly contact our offices for the minimum order quantity



TAB SYSTEM

**POCKET SYSTEM**

POCKET-TAB SYSTEM

DUO FACE SYSTEM

VELCRO SYSTEM

TOOLS WITH TANK

MOP SYSTEM

**MASTERTUFT** - cotton pocket mop, polyester backing, tufting, cut outside



REF.	NOTES	PCK	VOLUME (m³)	GROSS WEIGHT (kg)	SIZE (cm) ↓ ↓ ↓
00TM0401B00	for 40 x 11 cm mop holders	25	0,028	4,57	40x13
00TM0501B00	for mop holders 50 x 13 cm	25	0,043	6,08	50x16

Ideal for a medium level of dirt and frequent cleaning

**DREITUFT** - microfibre, cotton and polyester mop head, polyester backing, tufting, external cut wire, with pockets and colour-coded tag



REF.	NOTES	PCK	VOLUME (m³)	GROSS WEIGHT (kg)	SIZE (cm) ↓ ↓ ↓
00TM0414B00	for 40 x 11 cm mop holders	25	0,028	4,82	40x13
00TM0514B00	for mop holders 50 x 13 cm	25	0,043	6,08	50x16

Ideal for heavily soiled surfaces and deep cleaning

**MICRO-ACTIVA** - microfibre mop, polyester backing, with pockets and colour-coded tag



REF.	NOTES	PCK	VOLUME (m³)	GROSS WEIGHT (kg)	SIZE (cm) ↓ ↓ ↓
0000PN04012	for 40 x 11 cm mop holders	25	0,015	2,61	40x13
0000PN06012	for mop holders 50 x 13 cm	25	0,03	3,72	50x16

Ideal for all smooth surfaces with a medium dirt level

**SPEEDY PULI-SCRUB** microfibre and polypropylene mop, polyester backing, pockets and colour-coded tag



REF.	NOTES	PCK	VOLUME (m³)	GROSS WEIGHT (kg)	SIZE (cm) ↓ ↓ ↓
0000PN04011	for 40 x 11 cm mop holders	25	0,024	3,49	40x13

Ideal for all rough surfaces with a medium-high dirt level- |s|\_Ideal also to remove stubborn dirt and limestone

**PULI-BRUSH** - microfibre and polypropylene mop, polyester backing, pockets and colour-coded tag

**NEW**



REF.	NOTES	PCK	VOLUME (m³)	GROSS WEIGHT (kg)	SIZE (cm) ↓ ↓ ↓
00PN0418B00A	for 40 x 11 cm mop holders	25	0,028	2,88	40x13
00PN0418B00B	for 40 x 11 cm mop holders	25	0,028	2,88	40x13

Ideal for all rough surfaces with a medium-high dirt level- |s|\_Ideal also to remove stubborn dirt and limestone

**SMART-FUR** - microfibre mop with polyester backing, pockets and colour-coded tags



REF.	NOTES	PCK	VOLUME (m³)	GROSS WEIGHT (kg)	SIZE (cm) ↓ ↓ ↓
00PN0403B00	for 40 x 11 cm mop holders		0,025	3,12	40x13
00PN0403B00E	for 40 x 11 cm mop holders		0,056	6,48	40x13
00PN0503B00	for mop holders 50 x 13 cm		0,055	7,2	50x16
00PN0503B00E	for mop holders 50 x 13 cm		0,055	4,7	50x16

Ideal for all smooth surfaces with a medium-low dirt level



TAB SYSTEM

**POCKET SYSTEM**

POCKET-TAB SYSTEM

DUO FACE SYSTEM

VELCRO SYSTEM

TOOLS WITH TANK

MOP SYSTEM

## ACTIVE-FUR - microfiber mop with nylon inserts, polyester backing, pockets and colour-coded tags



REF.	NOTES		PCK	VOLUME (m <sup>2</sup> )	GROSS WEIGHT (kg)	SIZE (cm) ↓ ↓ ↓
00PN0406B00	for 40 x 11 cm mop holders		25	0,025	3	40x13
00PN0406B00E	for 40 x 11 cm mop holders		25	0,025	3	40x13
00PN0506B00	for mop holders 50 x 13 cm		25	0,03	4,13	50x16
00PN0506B00E	for mop holders 50 x 13 cm		25	0,03	3,75	50x16

Ideal for all smooth surfaces with a medium dirt level

## ENERGY-FUR - striped microfiber mop with polyester backing, pockets and colour-coded tags



REF.	NOTES		PCK	VOLUME (m <sup>2</sup> )	GROSS WEIGHT (kg)	SIZE (cm) ↓ ↓ ↓
00PN0413B00	for 40 x 11 cm mop holders		50	0,056	5,78	40x13
00PN0413B00E	for 40 x 11 cm mop holders		50	0,056	5,78	40x13
00PN0513B00	for mop holders 50 x 13 cm		25	0,03	3,83	50x16
00PN0513B00E	for mop holders 50 x 13 cm		25	0,03	3,5	50x16

Ideal for all smooth or rough surfaces with a medium dirt level

## ENERGY-FUR - white microfiber mop with blue stripes and abrasive, polyester backing, pockets and colour-coded tags



REF.	NOTES		PCK	VOLUME (m <sup>2</sup> )	GROSS WEIGHT (kg)	SIZE (cm) ↓ ↓ ↓
00PN0411B00	for 40 x 11 cm mop holders		50	0,056	6,28	40x13
00PN0511B00	for mop holders 50 x 13 cm		50	0,055	8,2	50x16

Ideal for all smooth surfaces with a medium dirt level

## MONO-MICRO - disposable nonwoven fabric pad, with pockets

**NEW**



REF.	NOTES		PCK	VOLUME (m <sup>2</sup> )	GROSS WEIGHT (kg)	SIZE (cm) ↓ ↓ ↓
00PU0415B00	Pck: 10 polybags with 25 pcs each		1	0,036	0,01	40

## MONO-MICRO - disposable microfibre pad, with pockets

**NEW**



REF.	NOTES		PCK	GROSS WEIGHT (kg)	SIZE (cm) ↓ ↓ ↓
00PU0416B00	Pck: 10 polybags with 25 pcs each		1	0,01	40



TAB SYSTEM

POCKET SYSTEM

**POCKET-TAB SYSTEM**

DUO FACE SYSTEM

VELCRO SYSTEM

TOOLS WITH TANK

MOP SYSTEM

## Mops POCKETS-FLAPS: 2 systems in 1

Filmop has expanded its own range of mop heads with models with both **pocket** and **flap** fastening. In this way, the same product may be used for **two different washing systems**, with significant advantages in terms of versatility and stock management.

The mops with pockets and flaps can be used with disinfection mop holders and with Uniko mop holder.

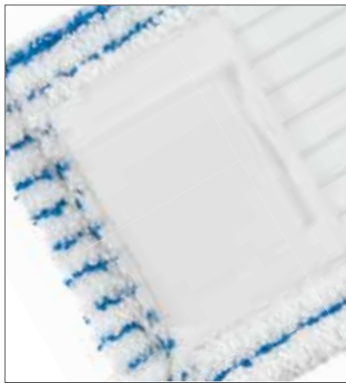

**NEW**

### ErgoSwing ergonomic system

The mop holders are available in the **ErgoSwing** version, for higher performance and lower effort.



Learn more about **ErgoSwing** in the handle section

## Frames for flaps/pockets mops

Foldable plastic mop holder with pockets and flaps



REF.	NOTES	PCK	VOLUME (m <sup>3</sup> )	GROSS WEIGHT (kg)	SIZE (cm) ↓ ↓ ↓
0000TP0004AB		10	0,021	4,34	40x11
0000TP0005AB		10	0,035	6,46	50x13

Foldable plastic mop holder for mops with pockets, flaps and Lock System joint



REF.	NOTES	PCK	VOLUME (m <sup>3</sup> )	GROSS WEIGHT (kg)	SIZE (cm) ↓ ↓ ↓
0000TP0304AB		10	0,021	0,34	40x11

Plastic folding frame for pocket and tab mop heads with ErgoSwing fitting

**NEW**



REF.	NOTES	PCK	VOLUME (m <sup>3</sup> )	GROSS WEIGHT (kg)	SIZE (cm) ↓ ↓ ↓
0000TP0904AB		10	0,028	5,05	40x11

Use with ErgoSwing system handle, code 0000AM3045





TAB SYSTEM

POCKET SYSTEM

**POCKET-TAB SYSTEM**

DUO FACE SYSTEM

VELCRO SYSTEM

TOOLS WITH TANK

MOP SYSTEM

## Pocket mops with flaps

Cotton mop with pockets and flaps, polyester backing, looped yarn inside and cut yarn outside



REF.	NOTES	PCK	VOLUME (m³)	GROSS WEIGHT (kg)	SIZE (cm) ↓ ↓ ↓
00FM0401D00		70	0,056	10,93	40x13
00FM0501D00		50	0,074	12,03	50x16

Microfiber pocket mop with flaps, polyester backing, looped yarn



REF.	NOTES	PCK	VOLUME (m³)	GROSS WEIGHT (kg)	SIZE (cm) ↓ ↓ ↓
00FC0402D00		25	0,028	4,69	40x13

**MASTERTUFT** - cotton mop, polyester backing, tufting, cut outside, with pockets and flaps

**NEW**



REF.	NOTES	PCK	VOLUME (m³)	GROSS WEIGHT (kg)	SIZE (cm) ↓ ↓ ↓
00TM0401D00		25	0,028	4,68	40x13
00TM0501D00		25	0,043	6,08	50x16

Ideal for a medium level of dirt and frequent cleaning

**DREITUFT** - microfiber, cotton and polyester mop, polyester backing, tufting, cut outside, with pockets and flaps

**NEW**



REF.	NOTES	PCK	VOLUME (m³)	GROSS WEIGHT (kg)	SIZE (cm) ↓ ↓ ↓
00TM0414D00		25	0,028	4,72	40x13
00TM0514D00		25	0,043	6,33	50x16

Ideal for heavily soiled surfaces and deep cleaning

**SMART-FUR** - microfiber mop, polyester backing, pockets and flaps, colour-coded tags



REF.	NOTES	PCK	VOLUME (m³)	GROSS WEIGHT (kg)	SIZE (cm) ↓ ↓ ↓
00PN0403D00		25	0,056	3,78	40x13
00PN0403D00E		25	0,025	3,47	40x13
00PN0503D00		25	0,031	3,5	50x16
00PN0503D00E		25	0,03	3,93	50x16

Ideal for all smooth surfaces with a medium-low dirt level

**ENERGY-FUR** - microfiber mop with nylon inserts, polyester backing, pockets and flaps, colour-coded tags



REF.	NOTES	PCK	VOLUME (m³)	GROSS WEIGHT (kg)	SIZE (cm) ↓ ↓ ↓
00PN0406D00		25	0,025	3,18	40x13
00PN0406D00E		25	0,025	3,2	40x13
00PN0506D00		50	0,055	9,3	50x16
00PN0506D00E		25	0,03	4	50x16

Ideal for all smooth surfaces with a medium dirt level



TAB SYSTEM

POCKET SYSTEM

**POCKET-TAB SYSTEM**

DUO FACE SYSTEM

VELCRO SYSTEM

TOOLS WITH TANK

MOP SYSTEM

**ENERGY-FUR** - striped microfiber mop, polyester backing, pockets and flaps, with colour-coded tags

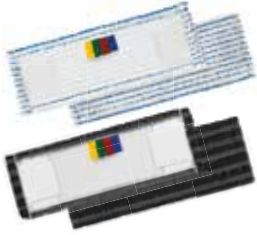

REF.	NOTES	PCK	VOLUME (m <sup>2</sup> )	GROSS WEIGHT (kg)	SIZE (cm) ↓ ↓ ↓
00PN0413D00		25	0,025	2,75	40x13
00PN0413D00E		50	0,056	6,48	40x13
00PN0513D00		25	0,03	3,75	50x16
00PN0513D00E		25	0,031	3,5	50x16

Ideal for all smooth or rough surfaces with a medium dirt level

**ENERGY-FUR** - white microfiber mop with blue stripes and abrasive, polyester backing, pockets and flaps and colour-coded tags



REF.	NOTES	PCK	VOLUME (m <sup>2</sup> )	GROSS WEIGHT (kg)	SIZE (cm) ↓ ↓ ↓
00PN0411D00		25	0,025	2,75	40x13
00PN0511D00		25	0,03	3,75	50x16

Ideal for all smooth surfaces with a medium dirt level



## Turn and double the face of clean!



**Duo Face** is the innovating combined system (mop holder + mops) designed by Filmop to simplify and optimize the cleaning of floors and vertical surfaces. The **reversible mop holder** and the **range of double-faced mops** allow to **double the efficiency** of the cleaning operations with one single system.



### Reversible mop holder

- Make full use of the double mop holder thanks to its two perfectly flat and reversible sides
- Fix the mop to the mop holder with 2 simple clicks: the special raised central part allows to insert the mop in the right position, its serrated external borders assure a stable and non-slip mop fixing
- Avoid any contact of the mop with your hands thanks to its foot-operated pedal devices
- Clean also the vertical surfaces very easily thanks to the Lock System technology
- Do not waste your strength: the central joint distributes the pressure uniformly onto the whole surface of the mop holder



### Double-faced mops

The two mop sides are made of 100% cleaning surface and matched together thanks to a special ultrasonic welding that makes seamless Duo Face mops **much more resistant** and **more hygienic**, as they have no pockets or extra material where dirt and bacteria would hide and grow.

Duo Face mops are **perfectly reversible**:

- **Turn the mop and double the square meters of surface:** use the first side of the mop, turn it and go on with the second side. 1 traditional mop cleans about 25 sqm, 1 Duo Face mop: 50 sqm.
- **Turn the mop and double the possible cleaning operations:** wash, turn and dry! Duo Face BAR-RIER mops are made with a special **waterproof barrier** inside that separates the two cleaning sides of the mop. Dry and wet finally together in one single mop.

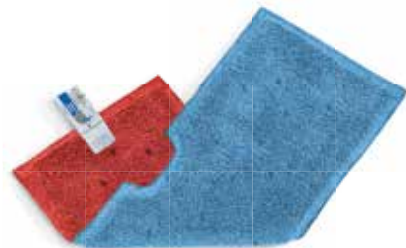

### Duo Face ultra-microfibers

Duo Face mops are the outcome of a long and **careful planning** that has involved Filmop R&D department for a long time to reach the best final result: a wide range of double-faced mops to satisfy several and different cleaning needs, manufactured with **completely Made in Italy** and **high quality microfiber** material.

Duo Face microfibers guarantee the maximum performance concerning **collection of dirt, release of dirt** during washing, **mop running, quality** of final cleaning results, **durability and mop lifetime**.

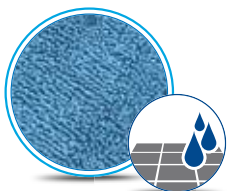

**WASH BASIC:**  
standard wet mopping

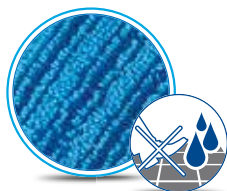

**WASH SAFE:**  
non-slip washing

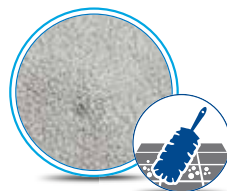

**DUST:**  
dry dusting

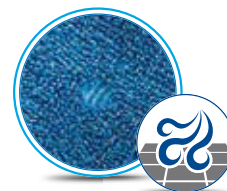

**DRY:**  
drying

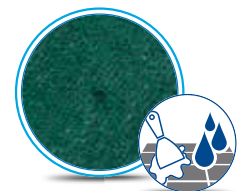

**SCRUBBY:**  
scrubbing



TAB SYSTEM

POCKET SYSTEM

POCKET-TAB SYSTEM

**DUO FACE SYSTEM**

VELCRO SYSTEM

TOOLS WITH TANK

MOP SYSTEM

## Duo Face mop holders

### DUO FACE - reversible plastic mop holder with Lock System



REF.	NOTES	PCK	VOLUME (m <sup>3</sup> )	GROSS WEIGHT (kg)	SIZE (cm) ↓ ↓ ↓
0000TP0303U		5	0,009	3,62	40

## Duo Face mops

### DUO FACE WASH BASIC - microfibre double-faced mop, floor wet mopping



REF.	NOTES	PCK	VOLUME (m <sup>3</sup> )	GROSS WEIGHT (kg)	SIZE (cm) ↓ ↓ ↓
00PD04L0L00AA		10	0,013	1,35	40
00PD04L0L00AB		10	0,013	1,35	40
00PD04L0L00BB		10	0,013	1,35	40
00PD04L0L00CC		10	0,013	1,35	40
00PD04L0L00FF		10	0,013	1,35	40

### DUO FACE WASH SAFE - microfiber double-faced mop, wet mopping on non-slip floors



REF.	NOTES	PCK	VOLUME (m <sup>3</sup> )	GROSS WEIGHT (kg)	SIZE (cm) ↓ ↓ ↓
00PD04L1L10AA		10	0,013	1,6	40

### DUO FACE DUST - microfibre double-faced mop, dry dusting



REF.	NOTES	PCK	VOLUME (m <sup>3</sup> )	GROSS WEIGHT (kg)	SIZE (cm) ↓ ↓ ↓
00PD04S0S00EE		10	0,013	1,5	40

### DUO FACE WASH BASIC/ SCRUBLY - microfibre double-faced mop, wet mopping / scrubbing action



REF.	NOTES	PCK	VOLUME (m <sup>3</sup> )	GROSS WEIGHT (kg)	SIZE (cm) ↓ ↓ ↓
00PD04L0L30AF		10	0,013	1,55	40
00PD04L0L30BF		10	0,013	1,55	40



TAB SYSTEM

POCKET SYSTEM

POCKET-TAB SYSTEM

**DUO FACE SYSTEM**

VELCRO SYSTEM

TOOLS WITH TANK

MOP SYSTEM

**DUO FACE WASH BASIC / WASH SAFE** - microfiber double-faced mop, wet mopping/wet mopping on non-slip floors



REF.	NOTES	PCK	VOLUME (m <sup>3</sup> )	GROSS WEIGHT (kg)	SIZE (cm) ↓ ↓ ↓
00PD04L0L10AA		10	0,013	1,45	40
00PD04L0L10BA		10	0,013	1,45	40

**DUO FACE WASH BASIC / DRY BARRIER** - microfiber double-faced mop, wet mopping/dry, with waterproof barrier



REF.	NOTES	PCK	VOLUME (m <sup>3</sup> )	GROSS WEIGHT (kg)	SIZE (cm) ↓ ↓ ↓
00PD04L0A01AA		10	0,013	1,7	40
00PD04L0A01BA		10	0,013	1,7	40

**MONO-MICRO DUO FACE** - reversible nonwoven fabric pad, standard mopping

**NEW**



REF.	NOTES	PCK	VOLUME (m <sup>3</sup> )	GROSS WEIGHT (kg)	SIZE (cm) ↓ ↓ ↓
00DU04L0L00	Pck: 10 polybags with 25 pcs each	1	0,025	3,99	40

**MONO-MICRO DUO FACE** - reversible microfibre pad, standard mopping

**NEW**



REF.	NOTES	PCK	VOLUME (m <sup>3</sup> )	GROSS WEIGHT (kg)	SIZE (cm) ↓ ↓ ↓
00DU04L1L10	Pck: 10 polybags with 25 pcs each	1	0,047	3,6	40



TAB SYSTEM

POCKET SYSTEM

POCKET-TAB SYSTEM

DUO FACE SYSTEM

**VELCRO SYSTEM**

TOOLS WITH TANK

MOP SYSTEM

**Disinfection with velcro system** provides effective results, is quick and ergonomic and can be used with all mops with backing for velcro system. The special trapezoidal shaped mop holders allow to clean edges and hard-to-reach areas, they are light and handy. The replaceable strips guarantee the utmost adherence of the mop holder to the mop for a perfect cleaning of the floor.

## HOW TO USE IT



Unsnap the cover of the TOP-DOWN® charging bucket and pick up the mop directly with the mop holder.



Start mopping and disinfecting the floor.



Hold mop ends with both feet and pull up the mop holder to remove the mop.



Throw the mop into the provided collection/waste bag.

## HOW TO REMOVE THE MOP

**NEW**

### ErgoSwing ergonomic system

The Velcro system mop holder is available in the **ErgoSwing** version, for higher performance and lower effort.



This system offers the following advantages:

- **less effort and fatigue** for the operator thanks to its lightness and simple use;
- **reduced costs** for the purchase of cleaning equipment thanks to the replaceable strips;
- **better performances**: excellent floor mopping and perfect cleaning of walls and skirting boards.

All Filmop mop holders can be equipped with **Lock System** that improves the cleaning of walls and ceilings just locking and unlocking the joint simply pushing up and down the special device using one's foot.



**Unlocked joint:** floor cleaning



**Locked joint:** cleaning of walls and ceilings

Learn more about **ErgoSwing** in the handle section

## Mop holders with velcro system

Mop holder with strips 2,5 cm for velcro system



REF.	NOTES	PCK	VOLUME (m³)	GROSS WEIGHT (kg)	SIZE (cm) ↓ ↓ ↓
5263A		10	0,016	2,32	30
5259A		10	0,019	2,92	40
5260A		10	0,03	4,42	60

Mop holder with strips 2,5 cm for velcro system and with Lock System joint



REF.	NOTES	PCK	VOLUME (m³)	GROSS WEIGHT (kg)	SIZE (cm) ↓ ↓ ↓
5359A		10	0,019	3,64	40
5360A		10	0,03	4,7	60



TAB SYSTEM

POCKET SYSTEM

POCKET-TAB SYSTEM

DUO FACE SYSTEM

**VELCRO SYSTEM**

TOOLS WITH TANK

MOP SYSTEM

Tool for 2.5 cm wide Velcro system profile mops with ErgoSwing joint

**NEW**



REF.	NOTES	PCK	VOLUME (m³)	GROSS WEIGHT (kg)	SIZE (cm) ↓ ↓ ↓
5959A		10	0,028	3,63	40
5960A		10	-	4,46	60

Use with ErgoSwing system handle, code 0000AM3045

Mop holder with strips 1,5 cm for velcro system



REF.	NOTES	PCK	VOLUME (m³)	GROSS WEIGHT (kg)	SIZE (cm) ↓ ↓ ↓
5278A		10	0,029	5,63	80
5279A		10	0,04	6,98	100

Mop holder with strips 1,5 cm for velcro system, with cloth star fixing clip



REF.	NOTES	PCK	VOLUME (m³)	GROSS WEIGHT (kg)	SIZE (cm) ↓ ↓ ↓
5256		10	0,019	3,24	40

## Components and accessories for mop holders with velcro system

Plastic joint with articulation



REF.	NOTES
4008A	

Lock System plastic joint



REF.	NOTES
4028AB	

Strip for velcro system



REF.	NOTES
P191085U	for mop holder 30 cm long side (23,3 cm)
P191077U	for mop holder 30 cm short side (20 cm)
P191068U	for mop holder 40 cm long side (35,4 cm)
P191069U	for mop holder 40 cm short side (32 cm)
P191071U	for mop holder 60 cm long side (52,2 cm)
P191070U	for mop holder 60 cm short side (48,6 cm)

Round cloth star fixing clip



REF.	NOTES
60062U	



TAB SYSTEM

POCKET SYSTEM

POCKET-TAB SYSTEM

DUO FACE SYSTEM

**VELCRO SYSTEM**

TOOLS WITH TANK

MOP SYSTEM

## Mops for velcro system

### Polyester-cotton mop with backing for velcro system



REF.	NOTES	PCK	VOLUME (m³)	GROSS WEIGHT (kg)	SIZE (cm) ↓ ↓ ↓
5803		25	0,019	2,84	40x10
5807		25	0,03	3,94	60x10

### Cotton mop with backing for velcro system



REF.	NOTES	PCK	VOLUME (m³)	GROSS WEIGHT (kg)	SIZE (cm) ↓ ↓ ↓
0000204A		25	0,015	2,06	40x10
0000205A		20	0,015	2,13	60x10

### Microfiber-cotton-polyester mop with backing for velcro system



REF.	NOTES	PCK	VOLUME (m³)	GROSS WEIGHT (kg)	SIZE (cm) ↓ ↓ ↓
0000264A		25	0,015	2,19	40x10
0000265A		20	0,015	2,59	60x10

### RAPIDO SUPER - high performance white ultra-microfiber mop with backing for velcro system



REF.	NOTES	PCK	VOLUME (m³)	GROSS WEIGHT (kg)	SIZE (cm) ↓ ↓ ↓
00PN0309A00DA		25	0,011	1,39	30x10
00PN0309A00DB		25	0,011	1,39	30x10
00PN0309A00DC		25	0,011	1,39	30x10
00PN0309A00DF		25	0,011	1,39	30x10
00PN0409A00DA		25	0,019	2,09	40x10
00PN0409A00DB		25	0,019	2,09	40x10
00PN0409A00DC		25	0,019	2,09	40x10
00PN0409A00DF		25	0,019	2,09	40x10
00PN0609A00DA		20	0,019	2,42	60x10
00PN0609A00DB		20	0,019	2,42	60x10
00PN0609A00DC		20	0,019	2,42	60x10
00PN0609A00DF		20	0,019	2,42	60x10



Ideal for any surface (especially the porous one) with a medium-high dirt level

### RAPIDO - white microfiber mop with coloured backing for velcro system



REF.	NOTES	PCK	VOLUME (m³)	GROSS WEIGHT (kg)	SIZE (cm) ↓ ↓ ↓
0000243DA		25	0,011	1,69	30x10
0000244DA		25	0,015	2,44	40x10
0000244DB		25	0,015	2,44	40x10
0000244DC		25	0,015	2,44	40x10
0000244DF		25	0,015	2,44	40x10
0000245DA		20	0,015	2,67	60x10

Ideal for any surface (especially the porous one) with a medium-high dirt level





TAB SYSTEM

POCKET SYSTEM

POCKET-TAB SYSTEM

DUO FACE SYSTEM

**VELCRO SYSTEM**

TOOLS WITH TANK

MOP SYSTEM





## RAPIDO - white microfibre mop head for large surfaces, with Velcro backing



REF.	NOTES	PCK	VOLUME (m³)	GROSS WEIGHT (kg)	SIZE (cm) ↓ ↓ ↓
0000246DA	for mop holder art. 5201/28 and art. 5278	14	0,015	2,71	80x10
0000247DA	for mop holder art. 5201/21 and art. 5278	10	0,015	2,39	100x10

## RAPIDO - coloured microfibre mop with coloured backing for velcro system



REF.	NOTES	PCK	VOLUME (m³)	GROSS WEIGHT (kg)	SIZE (cm) ↓ ↓ ↓
0000214AA		25	0,015	2,44	40x10
0000214BB		25	0,015	2,44	40x10
0000214CC		25	0,015	2,44	40x10
0000214FF		25	0,015	2,44	40x10

## MASTERTUFT - cotton mop, polyester backing, tufting, cut outside, with velcro system

**NEW**

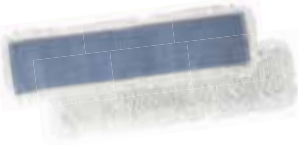

REF.	NOTES	PCK	VOLUME (m³)	GROSS WEIGHT (kg)	SIZE (cm) ↓ ↓ ↓
00TM0401A00		25	0,028	0,57	40
00TM0601A00		25	0,043	0,58	60

Ideal for a medium level of dirt and frequent cleaning

## DREITUFT - microfibre mop, cotton and polyester mop, polyester backing, tufting, cut outside, with velcro system

**NEW**

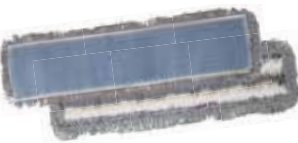

REF.	NOTES	PCK	VOLUME (m³)	GROSS WEIGHT (kg)	SIZE (cm) ↓ ↓ ↓
00TM0414A00		25	0,028	0,57	40
00TM0614A00		25	0,043	0,58	60

Ideal for heavily soiled surfaces and deep cleaning

## MICRO-ACTIVA - microfibre mop with backing for velcro system and colour-coded tags



REF.	NOTES	PCK	VOLUME (m³)	GROSS WEIGHT (kg)	SIZE (cm) ↓ ↓ ↓
0000PN02012		25	0,011	1,32	30
0000PN03012		25	0,015	1,86	40
0000PN03022		25	0,03	2,77	60

Ideal for all smooth surfaces with a medium dirt level

## PULI-SCRUB - microfibre mop with polypropylene stripes, with backing for velcro system and colour-coded tags



REF.	NOTES	PCK	VOLUME (m³)	GROSS WEIGHT (kg)	SIZE (cm) ↓ ↓ ↓
0000PN02011		25	0,011	1,49	30
0000PN03011		25	0,015	2,26	40
0000PN03021		25	0,03	3,32	60

Ideal for all rough surfaces with a medium-high dirt level- Ideal also to remove stubborn dirt and limestone



TAB SYSTEM

POCKET SYSTEM

POCKET-TAB SYSTEM

DUO FACE SYSTEM

**VELCRO SYSTEM**

TOOLS WITH TANK

MOP SYSTEM

**PULI-BRUSH** - microfibre and polypropylene Velcro pad, with colour-coded label

**NEW**



REF.	NOTES	PCK	VOLUME (m <sup>3</sup> )	GROSS WEIGHT (kg)	SIZE (cm) ↓ ↓ ↓
00PN0418A00A		25	0,014	2,03	40
00PN0418A00B		25	0,014	2,03	40

Ideal for all rough surfaces with a medium-high dirt level - Ideal also to remove stubborn dirt and limestone

**SMART-FUR** - bordered microfiber mop with backing for velcro system and colour-coded tags



REF.	NOTES	PCK	VOLUME (m <sup>3</sup> )	GROSS WEIGHT (kg)	SIZE (cm) ↓ ↓ ↓
00PN0403H00		25	0,015	1,69	40
00PN0403H00E		25	0,015	1,69	40
00PN0603H00		20	0,015	1,79	60
00PN0603H00E		20	0,015	1,79	60



Ideal for all smooth surfaces with a low-medium dirt level - The shock-absorbing border guarantees a better protection for and against baseboards and walls

**SMART-FUR** - microfiber mop with backing for velcro system and colour-coded tags

**NEW**



REF.	NOTES	PCK	VOLUME (m <sup>3</sup> )	GROSS WEIGHT (kg)	SIZE (cm) ↓ ↓ ↓
00PN0403A00		25	0,015	1,69	40
00PN0403A00E		25	0,015	1,69	40
00PN0603A00		20	0,015	1,79	60
00PN0603A00E		20	0,015	1,79	60

Ideal for all smooth surfaces with a medium-low dirt level

**ACTIVE-FUR** - bordered microfiber mop with nylon inserts, backing for velcro system and colour-coded tags



REF.	NOTES	PCK	VOLUME (m <sup>3</sup> )	GROSS WEIGHT (kg)	SIZE (cm) ↓ ↓ ↓
00PN0406H00		25	0,015	1,74	40
00PN0406H00E		25	0,015	1,74	40
00PN0606H00		20	0,015	2,27	60
00PN0606H00E		20	0,015	2,27	60



Ideal for all smooth surfaces with a medium dirt level - The shock-absorbing border guarantees a better protection for and against baseboards and walls



TAB SYSTEM

POCKET SYSTEM

POCKET-TAB SYSTEM

DUO FACE SYSTEM

**VELCRO SYSTEM**

TOOLS WITH TANK

MOP SYSTEM

## ACTIVE-FUR - microfiber mop with nylon inserts, backing for velcro system and colour-coded tags

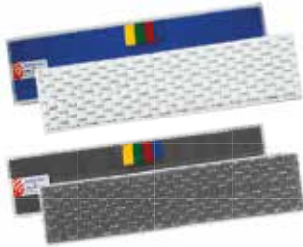

REF.	NOTES	PCK	VOLUME (m <sup>3</sup> )	GROSS WEIGHT (kg)	SIZE (cm) ↓ ↓ ↓
00PN0406A00		25	0,015	1,74	40
00PN0406A00E		25	0,015	1,74	40
00PN0606A00		20	0,015	2,27	60
00PN0606A00E		20	0,015	2,27	60

Ideal for all smooth surfaces with a medium dirt level

## SKILL-FUR - striped bordered microfiber mop, backing for velcro system and colour-coded tags



REF.	NOTES	PCK	VOLUME (m <sup>3</sup> )	GROSS WEIGHT (kg)	SIZE (cm) ↓ ↓ ↓
00PN0413H00		25	0,015	1,34	40
00PN0413H00E		25	0,015	1,34	40
00PN0613H00		20	0,015	1,91	60
00PN0613H00E		20	0,015	1,91	60



Ideal for all smooth or rough surfaces with a medium dirt level - The shock-absorbing border guarantees a better protection for and against baseboards and walls

## SKILL-FUR - striped microfiber mop with backing for velcro system and colour-coded tags

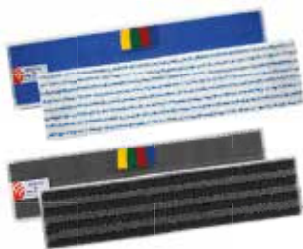

REF.	NOTES	PCK	VOLUME (m <sup>3</sup> )	GROSS WEIGHT (kg)	SIZE (cm) ↓ ↓ ↓
00PN0413A00		25	0,015	1,34	40
00PN0413A00E		25	0,015	1,34	40
00PN0613A00		20	0,015	1,91	60
00PN0613A00E		20	0,015	1,91	60

Ideal for all smooth or rough surfaces with a medium dirt level

## ENERGY-FUR - bordered white microfiber mop with blue stripes and abrasive, backing for velcro system and colour-coded tags



REF.	NOTES	PCK	VOLUME (m <sup>3</sup> )	GROSS WEIGHT (kg)	SIZE (cm) ↓ ↓ ↓
00PN0411H00		25	0,015	1,59	40
00PN0611H00		20	0,015	2,11	60



Ideal for all smooth surfaces with a medium dirt level - The shock-absorbing border guarantees a better protection for and against baseboards and walls



TAB SYSTEM

POCKET SYSTEM

POCKET-TAB SYSTEM

DUO FACE SYSTEM

**VELCRO SYSTEM**

TOOLS WITH TANK

MOP SYSTEM

**ENERGY-FUR** - white microfiber mop with blue stripes and abrasive, with backing for velcro system and colour-coded tags



REF.	NOTES	PCK	VOLUME (m³)	GROSS WEIGHT (kg)	SIZE (cm) ↓ ↓ ↓
00PN0411A00		25	0,015	14,19	40
00PN0611A00		20	0,015	2,11	60

Ideal for all smooth surfaces with a medium dirt level

**MONO-MICRO** - disposable nonwoven fabric Velcro pad

**NEW**



REF.	NOTES	PCK	VOLUME (m³)	GROSS WEIGHT (kg)	SIZE (cm) ↓ ↓ ↓
00PU0415A00	Pck: 10 polybags with 25 pcs each	1	0,034	3,08	40

**MONO-MICRO** - disposable microfibre Velcro pad

**NEW**



REF.	NOTES	PCK	VOLUME (m³)	GROSS WEIGHT (kg)	SIZE (cm) ↓ ↓ ↓
00PU0416A00	pack: 10 bags of 25	1	0,037	2,9	40

## Mop holders with Microplast strips

Cloth holder with strips **MICROPLAST**



REF.	NOTES	PCK	VOLUME (m³)	GROSS WEIGHT (kg)	SIZE (cm) ↓ ↓ ↓
5264A		10	0,019	3,22	40

Cloth holder with strips **MICROPLAST**, with Lock System



REF.	NOTES	PCK	VOLUME (m³)	GROSS WEIGHT (kg)	SIZE (cm) ↓ ↓ ↓
5364A		10	0,019	3,52	40

**MICROPLAST** flat mop frame with strips, with ErgoSwing fitting

**NEW**



REF.	NOTES	PCK	VOLUME (m³)	GROSS WEIGHT (kg)	SIZE (cm) ↓ ↓ ↓
5964A		10	0,028	3,93	40

Use with ErgoSwing system handle, code 0000AM3045



TAB SYSTEM

POCKET SYSTEM

POCKET-TAB SYSTEM

DUO FACE SYSTEM

**VELCRO SYSTEM**

TOOLS WITH TANK

MOP SYSTEM

## Disposable microfiber cloth



REF.	NOTES	PCK	VOLUME (m³)	GROSS WEIGHT (kg)	SIZE (cm) ↓ ↓ ↓
0000PN02040	pck.: 10 polybags with 50 pcs	1	0,065	6,25	42x13

## MONO-MICRO - disposable nonwoven fabric Velcro pad

**NEW**



REF.	NOTES	PCK	VOLUME (m³)	GROSS WEIGHT (kg)	SIZE (cm) ↓ ↓ ↓
00PU0415A00	Pck: 10 polybags with 25 pcs each	1	0,034	3,08	40

## MONO-MICRO - disposable microfibre Velcro pad

**NEW**



REF.	NOTES	PCK	VOLUME (m³)	GROSS WEIGHT (kg)	SIZE (cm) ↓ ↓ ↓
00PU0416A00	pack: 10 bags of 25	1	0,037	2,9	40

## Components and accessories for Microplast cloth holders

### Plastic joint with articulation



REF.	NOTES
4008A	

### Lock System plastic joint



REF.	NOTES
4028AB	

### Strip for mop holder **MICROPLAST**



REF.	NOTES
P291050H	short side (31,7 cm)
P291051H	long side (35,3 cm)



TAB SYSTEM

POCKET SYSTEM

POCKET-TAB SYSTEM

DUO FACE SYSTEM

VELCRO SYSTEM

**TOOLS WITH TANK**

MOP SYSTEM

**Unilav** is a wet mopping and/or disinfection tool for medium small areas, such as stairs, offices, bars, small shops with a medium degree of dirt. It is very useful for quick actions. In combination with microfiber cloths or with disposable cloths, it guarantees excellent cleaning results. Very simple and quick to use, light, handy and ergonomic.



Two types of refilling bottle: 650 ml and 1000 ml in different colours: red, blue, green and yellow.



The side-grip allows to regulate the release of cleaning solution: continuous flow or intermittent flow.

In order to have a complete disinfection system, Filmop offers also a **Unilav kit** that allows the operator to carry all the necessary equipment during the cleaning operations, optimizing working time.



**Sanety** tool is equipped with a special pierced "flowthrough" plate that allows a uniform distribution of the cleaning solution on the floor, thus avoiding waste of product.

## HOW TO PREPARE IT



Lift up the plastic cover and fix it to the handle grip.



Fill in the tank.

## HOW TO USE IT



Press and release the knob at the top of the grip for an intermittent wax flowing; press and block the knob for a continuous wax flowing.



The rubber cover on the handle grip avoids dirt and bacteria inside the hole and guarantees a more stable leaning of the tool against the walls.



TAB SYSTEM

POCKET SYSTEM

POCKET-TAB SYSTEM

DUO FACE SYSTEM

VELCRO SYSTEM

**TOOLS WITH TANK**

MOP SYSTEM

## **NEW** Sprinter Plus: kit for an easy and fast floor cleaning



Sprinter is a professional floor washing system that ensures **excellent results**. The handle with reservoir is **light**, and **easy to handle and use**: simply pour the detergent solution into the reservoir and press the button to spray the liquid directly on the floor. The reservoir capacity offers a cleaning autonomy of approximately 80 m<sup>2</sup>, making it **ideal for small to medium areas** such as offices, bars and shops.



**500 ml capacity**



Sprinter is available in the complete **Kit Sprinter Plus** version, including handle with reservoir, Velcro system mop holder and microfibre mop.



## Miscellaneous tools

**UNILAV SIDE GRIP** - disinfection tool with refilling bottle 650 ml and Duo Face mop holder



REF.	NOTES	PCK	VOLUME (m <sup>3</sup> )	GROSS WEIGHT (kg)
0000TD0120A		1	0,039	2,26





TAB SYSTEM

POCKET SYSTEM

POCKET-TAB SYSTEM

DUO FACE SYSTEM

VELCRO SYSTEM

**TOOLS WITH TANK**

MOP SYSTEM

**UNILAV SIDE GRIP** - flat mop with 650ml bottle and holder with Velcro strips



REF.	NOTES		PCK	VOLUME (m <sup>3</sup> )	GROSS WEIGHT (kg)
0000TD0151A	with plate 40 cm		1	0,038	2
0000TD0151U	with plate 40 cm		1	0,038	2,57
0000TD0161A	with plate 60 cm		1	0,038	2,57



Kit **SPRINTER PLUS** - tank handle 500 ml with mop holder 40 cm with strips for velcro system and bordered Skill-Fur microfiber mop



REF.	NOTES		PCK	VOLUME (m <sup>3</sup> )	GROSS WEIGHT (kg)
0001TD0451A			1	0,021	1,57



**Unilav Side Grip for disposable pads**

**UNILAV SIDE GRIP** - disinfection tool with refilling bottle 650 ml and cloth holder with Microplast strips 40 cm



REF.	NOTES		PCK	VOLUME (m <sup>3</sup> )	GROSS WEIGHT (kg)
0000TD0145A			1	0,038	2,41







TAB SYSTEM

POCKET SYSTEM

POCKET-TAB SYSTEM

DUO FACE SYSTEM

VELCRO SYSTEM

**TOOLS WITH TANK**

MOP SYSTEM

**UNILAV SIDE GRIP** - disinfection tool with refilling bottle 650 ml and cloth holder with rubber lamellas 40 cm



REF.	NOTES	PCK	VOLUME (m <sup>3</sup> )	GROSS WEIGHT (kg)
0000TD0130A		1	0,038	2,23



Disposable cloth made of polyester, polypropylene and cellulose



REF.	NOTES	PCK	VOLUME (m <sup>3</sup> )	GROSS WEIGHT (kg)	SIZE (cm) ↓ ↓ ↓
0000PN02030	Pck: 10 polybags with 25 pcs each	1	0,036	3,33	20x42,5

For tools with blade plate

## Sanety tool

**SANETY** - disinfection tool with bottle 1,5 L



REF.	NOTES	PCK	VOLUME (m <sup>3</sup> )	GROSS WEIGHT (kg)
8149	with plate 60 cm	1	0,038	2,45



Disinfection mop for Sanety tool, mixed cotton



REF.	NOTES	PCK	VOLUME (m <sup>3</sup> )	GROSS WEIGHT (kg)	SIZE (cm) ↓ ↓ ↓
8136		100	0,06	8,79	65x15



TAB SYSTEM

POCKET SYSTEM

POCKET-TAB SYSTEM

DUO FACE SYSTEM

VELCRO SYSTEM

**TOOLS WITH TANK**

MOP SYSTEM

## MICRO-ACTIVA - microfiber mop with backing for velcro system and colour-coded tags



REF.	NOTES	PCK	VOLUME (m <sup>3</sup> )	GROSS WEIGHT (kg)	SIZE (cm) ↓ ↓ ↓
0000PN02012		25	0,011	1,32	30
0000PN03012		25	0,015	1,86	40
0000PN03022		25	0,03	2,77	60

Ideal for all smooth surfaces with a medium dirt level

## PULI-SCRUB - microfiber mop with polypropylene stripes, with backing for velcro system and colour-coded tags



REF.	NOTES	PCK	VOLUME (m <sup>3</sup> )	GROSS WEIGHT (kg)	SIZE (cm) ↓ ↓ ↓
0000PN02011		25	0,011	1,49	30
0000PN03011		25	0,015	2,26	40
0000PN03021		25	0,03	3,32	60

Ideal for all rough surfaces with a medium-high dirt level- Is Ideal also to remove stubborn dirt and limestone

## RAPIDO - white microfiber mop with coloured backing for velcro system



REF.	NOTES	PCK	VOLUME (m <sup>3</sup> )	GROSS WEIGHT (kg)	SIZE (cm) ↓ ↓ ↓
0000243DA		25	0,011	1,69	30x10
0000244DA		25	0,015	2,44	40x10
0000244DB		25	0,015	2,44	40x10
0000244DC		25	0,015	2,44	40x10
0000244DF		25	0,015	2,44	40x10
0000245DA		20	0,015	2,67	60x10

Ideal for any surface (especially the porous one) with a medium-high dirt level

## Parts and accessories for flat mops with reservoir

### Belt for Unilav kit



REF.	NOTES
Q0400108	



### Blue plastic-coated bag for clean mops for Unilav kit



REF.	NOTES
Q0400105A	

### Red plastic-coated bag for dirty mops for Unilav kit



REF.	NOTES
Q0400106B	



TAB SYSTEM

POCKET SYSTEM

POCKET-TAB SYSTEM

DUO FACE SYSTEM

VELCRO SYSTEM

**TOOLS WITH TANK**

MOP SYSTEM

## Blue plastic-coated bottle holder for Unilav kit



REF.	NOTES
Q0400107A	

## Transparent refilling bottle with coloured screw cap for Unilav tool



REF.	NOTES	CAPACITY (L)	SIZE (cm) ↓ ↓ ↓
P291029A		0,65	25,5
P291029B		0,65	25,5
P291029C		0,65	25,5
P291029F		0,65	25,5
P291030A		1	34
P291030B		1	34
P291030C		1	34
P291030F		1	34

## SPRINTER - tank handle 500 ml

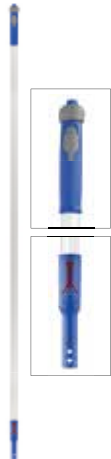

REF.	NOTES	PCK	VOLUME (m³)	GROSS WEIGHT (kg)	SIZE (cm) ↓ ↓ ↓
0000TD0400A		5	0,021	3,31	145



## Filling hole cap for Sprinter tool



REF.	NOTES
P191099U	



## Graduated plastic jar



REF.	NOTES	PCK	VOLUME (m³)	GROSS WEIGHT (kg)
P191000T	3 L	12	0,073	2,96
P192000T	0,5 L	80	-	3,84



TAB SYSTEM

POCKET SYSTEM

POCKET-TAB SYSTEM

DUO FACE SYSTEM

VELCRO SYSTEM

**TOOLS WITH TANK**

MOP SYSTEM

## Blue rubber cover for knob for Sanety and Slider tools



REF.	NOTES
P191084A	

## Silicon tube



REF.	NOTES	SIZE (cm) ↓ ↓ ↓
P191045T	for Unilav tool	36
P191021T	for Sanety tool	40



TAB SYSTEM

POCKET SYSTEM

POCKET-TAB SYSTEM

DUO FACE SYSTEM

VELCRO SYSTEM

TOOLS WITH TANK

**MOP SYSTEM**

## YARNS



### COTTON

Natural highly absorbing fiber. Open-end cotton version. Fitting all kinds of inside floors.

50°



### STRIPE MOP

String mop made of microfiber stripes. It penetrates the micro pores of the floor absorbing the removed dirt and retaining it till mop washing. High absorbing capacity. Fitting all kinds of inside floors.

90°



### DREAM MOP

Microfiber mop. It penetrates the micro pores of the floor absorbing the removed dirt and retaining it till mop washing. High absorbing capacity. Fitting all kinds of inside floors.

30°



### SYNTHETIC MOP

Synthetic fiber which keeps dirt and, at the same time, it looks clean. Very resistant to strong chemical products, like bleach. Advised for food and chemical industry.

30°

Please, refer to page 11 for the washing instructions.

## YARN MANUFACTURING PROCESS



### LOOPED YARN

It grants a longer life of the mop: this yarn processing prevents from mop fraying and linting.



### TWISTED YARN

It guarantees a more compact yarn making easier the cleaning operations.



### BAND

It guarantees a uniform distribution of the mop strings on the floor and avoids getting trapped into possible obstacles in the cleaning area.

## KIND OF SUPPORT



5 cm support



8 cm support

## **NEW** New Stripe Mops available in 4 colours

The microfiber stripes penetrate deeply into the grooves and pores of the floor, trapping dirt and releasing it only during washing.



blue, red,  
yellow, green



**green solutions**

Produced with solar energy

**MADE IN ITALY**





TAB SYSTEM

POCKET SYSTEM

POCKET-TAB SYSTEM

DUO FACE SYSTEM

VELCRO SYSTEM

TOOLS WITH TANK

**MOP SYSTEM**

## Mops

### Open-end cotton mop with 8 cm support



REF.	NOTES	WEIGHT (gr)	PCK	VOLUME (m <sup>2</sup> )	GROSS WEIGHT (kg)
6013		350	50	0,09	18,56
6014		400	50	0,09	21,06
6109		460	50	0,106	24,11
6110		500	50	0,106	26,11
6111		560	50	0,124	29,22

### Open-end cotton mop with band and 8 cm support



REF.	NOTES	WEIGHT (gr)	PCK	VOLUME (m <sup>2</sup> )	GROSS WEIGHT (kg)
6015		350	50	0,09	18,56
6016		400	50	0,09	21,06
6112		460	50	0,106	24,11
6113		500	50	0,106	26,11

### Open-end cotton mop with 5 cm support



REF.	NOTES	WEIGHT (gr)	PCK	VOLUME (m <sup>2</sup> )	GROSS WEIGHT (kg)
6000		350	50	0,09	18,56
6001		400	50	0,09	21,06

### Open-end cotton mop, looped yarn



REF.	NOTES	WEIGHT (gr)	PCK	VOLUME (m <sup>2</sup> )	GROSS WEIGHT (kg)
6030		400	50	0,09	21,06
6031		460	50	0,106	24,11

### Open-end cotton mop, looped yarn, with band



REF.	NOTES	WEIGHT (gr)	PCK	VOLUME (m <sup>2</sup> )	GROSS WEIGHT (kg)
6035		400	50	0,09	21,06
6036		460	50	0,106	24,11

### Open-end cotton mop with coloured yarn



REF.	NOTES	WEIGHT (gr)	PCK	VOLUME (m <sup>2</sup> )	GROSS WEIGHT (kg)
6050A		400	50	0,09	21,06
6050B		400	50	0,09	21,06
6050F		400	50	0,09	21,06



TAB SYSTEM

POCKET SYSTEM

POCKET-TAB SYSTEM

DUO FACE SYSTEM

VELCRO SYSTEM

TOOLS WITH TANK

**MOP SYSTEM**

## STRIPE MOP - blue microfiber mop with stripes, looped yarn



REF.	NOTES	WEIGHT (gr)	PCK	VOLUME (m <sup>3</sup> )	GROSS WEIGHT (kg)
6206A		240	25	0,055	6,7

## STRIPE MOP - coloured microfiber stripe mop

**NEW**



REF.	NOTES	WEIGHT (gr)	PCK	VOLUME (m <sup>3</sup> )	GROSS WEIGHT (kg)
6207A		250	25	0,05	7,12
6207B		250	25	0,05	7,12
6207C		250	25	0,05	7,12
6207F		250	25	0,05	7,12
6208A		350	25	0,09	9,81

## Synthetic mop, twisted yarn



REF.	NOTES	WEIGHT (gr)	PCK	VOLUME (m <sup>3</sup> )	GROSS WEIGHT (kg)
6202D	with white support		50	0,124	13,72
6202DA	with blue support		50	0,124	13,72
6202DB	with red support		50	0,124	13,72
6202DC	with yellow support		50	0,124	13,72
6202DF	with green support		50	0,124	13,72

## DREAM MOP - white-blue microfiber mop, looped yarn



REF.	NOTES	WEIGHT (gr)	PCK	VOLUME (m <sup>3</sup> )	GROSS WEIGHT (kg)
6205D		350	25	0,055	9,45
6204D		400	25	0,09	11,06

## White synthetic mop with coloured support



REF.	NOTES	WEIGHT (gr)	PCK	VOLUME (m <sup>3</sup> )	GROSS WEIGHT (kg)
6201D	with white support		50	0,113	12,5
6201DA	with blue support		50	0,148	13,83
6201DB	with red support		50	0,148	13,83
6201DC	with yellow support		50	0,148	13,83
6201DF	with green support		50	0,148	13,83



TAB SYSTEM

POCKET SYSTEM

POCKET-TAB SYSTEM

DUO FACE SYSTEM





VELCRO SYSTEM

TOOLS WITH TANK

**MOP SYSTEM**

## White synthetic mop with coloured band and coloured support



REF.	NOTES	PCK	VOLUME (m <sup>3</sup> )	GROSS WEIGHT (kg)
6211D	with white band and white support 	50	0,148	13,83
6211DA	with blue band and blue support 	50	0,148	13,83
6211DB	with red band and red support 	50	0,148	13,83
6211DC	with yellow band and yellow support 	50	0,148	13,83
6211DF	with green band and green support 	50	0,148	13,83

## Coloured synthetic mop



REF.	NOTES	PCK	VOLUME (m <sup>3</sup> )	GROSS WEIGHT (kg)
6201A		50	0,148	15,33

Available while stocks last

## Coloured synthetic mop with band







REF.	NOTES	PCK	VOLUME (m <sup>3</sup> )	GROSS WEIGHT (kg)
6211A		50	0,148	15,33

Available while stocks last

## Mop holders





### Big plastic mop holder



REF.	NOTES	PCK	VOLUME (m <sup>3</sup> )	GROSS WEIGHT (kg)
6020U-10		50	0,035	4,89
6020A-10		50	0,035	4,89
6020B-10		50	0,035	4,89
6020C-10		50	0,035	4,89
6020F-10		50	0,035	4,89

### Plastic mop holder with fixing clip for mop, big size



REF.	NOTES	PCK	VOLUME (m <sup>3</sup> )	GROSS WEIGHT (kg)
6020U/1-10		50	0,035	4,99
6020A/1-10		50	0,035	4,99
6020B/1-10		50	0,035	5,49
6020C/1-10		50	0,035	4,99
6020F/1-10		50	0,035	4,99





TAB SYSTEM

POCKET SYSTEM

POCKET-TAB SYSTEM

DUO FACE SYSTEM

VELCRO SYSTEM

TOOLS WITH TANK

**MOP SYSTEM**

## Regular plastic mop holder for mop



REF.	NOTES	PCK	VOLUME (m³)	GROSS WEIGHT (kg)
6021	only for handles with thread	50	0,028	3,57

Available while stocks last

## Bags for mop washing

### White polyester mesh bag with rubber string



REF.	NOTES	CAPACITY (L)	SIZE (cm) ↓ ↓ ↓
6073		70	90x77
6074		90	95x95

### Mesh bag with closing string



REF.	NOTES	CAPACITY (L)	SIZE (cm) ↓ ↓ ↓
0000AT0210A	polypropylene	30	30x60
0000AT0210B	polypropylene	30	30x60
0000AT0210C	polypropylene	30	30x60
0000AT0210F	polypropylene	30	30x60
0000AT0211A	polyester	50	30x90
0000AT0211B	polyester	50	30x90
0000AT0212A	stabilized polyester	70	60x90
0000AT0212B	stabilized polyester	70	60x90

Ideal for supports art. P1909914U, P1909926U and P1909927U

## Master Lux, Italian screw

### MASTER LUX - cotton mop with thick yarn, plastic support



REF.	NOTES	WEIGHT (gr)	PCK	VOLUME (m³)	GROSS WEIGHT (kg)
2035	with blue plastic support	170	50	0,055	9,23
2035B	with red plastic support	170	50	0,055	9,23
2036	with blue plastic support	220	50	0,055	11,73
2036B	with red plastic support	220	50	0,055	11,73
2037	with blue plastic support	280	50	0,073	14,84
2037B	with red plastic support	280	50	0,073	14,84
2037C	with yellow plastic support	280	50	0,073	14,84
2037F	with green plastic support	280	50	0,073	14,84
2045	with blue plastic support	400	50	0,091	20,98



TAB SYSTEM

POCKET SYSTEM

POCKET-TAB SYSTEM

DUO FACE SYSTEM



VELCRO SYSTEM

TOOLS WITH TANK

**MOP SYSTEM**







## MASTER LUX - cotton mop with thick yarn, looped yarn, plastic support



REF.	NOTES	WEIGHT (gr)	PCK	VOLUME (m <sup>3</sup> )	GROSS WEIGHT (kg)
3036	with blue plastic support 	220	50	0,073	11,84
3037	with blue plastic support 	280	50	0,07	15,4





## MASTER LUX - cotton mop with thin yarn, plastic support



REF.	NOTES	WEIGHT (gr)	PCK	VOLUME (m <sup>3</sup> )	GROSS WEIGHT (kg)
2038	with blue plastic support 	170	50	0,055	9,23
2039	with blue plastic support 	220	50	0,073	11,84
2040	with blue plastic support 	280	50	0,073	14,84
2040B	with red plastic support 	280	50	0,073	14,84
2040C	with yellow plastic support 	280	50	0,073	14,84
2040F	with green plastic support 	280	50	0,073	14,84
2046	with blue plastic support 	330	50	0,091	17,48

## MASTER LUX - synthetic mop with plastic support







REF.	NOTES	PCK	VOLUME (m <sup>3</sup> )	GROSS WEIGHT (kg)
6300D	white, with blue plastic support 	50	0,091	8,98
6300AA	blue, with blue plastic support 	50	0,091	8,98
6300B	white, with red plastic fitting 	50	0,091	8,98
6300C	white, with yellow plastic fitting 	50	0,091	8,98
6300F	white, with green plastic fitting 	50	0,091	8,98

Item no. 6300AA: Available while stocks last





## MASTER LUX - synthetic white mop, twisted yarn, with plastic support



REF.	NOTES	PCK	VOLUME (m <sup>3</sup> )	GROSS WEIGHT (kg)
6400D	with blue plastic support 	50	0,091	10,48
6400B	with red plastic support 	50	0,091	10,48
6400C	with yellow plastic support 	50	0,091	10,48
6400F	with green plastic support 	50	0,091	10,48

## DREAM MOP - white-blue microfiber mop with plastic support and looped yarn



REF.	NOTES	PCK	VOLUME (m <sup>3</sup> )	GROSS WEIGHT (kg)
6310D	with blue plastic support 	25	0,034	6,07
6310B	with red plastic support 	25	0,034	6,07
6310C	with yellow plastic support 	25	0,034	6,07
6310F	with green plastic support 	25	0,034	6,07



TAB SYSTEM

POCKET SYSTEM

POCKET-TAB SYSTEM

DUO FACE SYSTEM

VELCRO SYSTEM

TOOLS WITH TANK

**MOP SYSTEM**

## STRIPE MOP - mop made of microfiber stripes, with plastic support

**NEW**



REF.	NOTES	WEIGHT (gr)	PCK	VOLUME (m <sup>3</sup> )	GROSS WEIGHT (kg)
6320A		200	25	0,048	5,57
6320B		200	25	0,048	5,57
6320C		200	25	0,048	5,57
6320F		200	25	0,048	5,57

## Moppy

### MOPPY - cotton mop with thin yarn



REF.	NOTES	WEIGHT (gr)	PCK	VOLUME (m <sup>3</sup> )	GROSS WEIGHT (kg)
0000M02230		220	50	0,082	12,01
0000M02530		250	50	0,082	13,51

### MOPPY - white synthetic mop



REF.	NOTES	PCK	VOLUME (m <sup>3</sup> )	GROSS WEIGHT (kg)
0000M0013D		50	0,082	9,41

### Plastic mop holder with ring for Moppy



REF.	NOTES	PCK	VOLUME (m <sup>3</sup> )	GROSS WEIGHT (kg)
6025A		50	0,035	5,49

### Plastic mop holder with screw for Moppy



REF.	NOTES	PCK	VOLUME (m <sup>3</sup> )	GROSS WEIGHT (kg)
6027F	only for handles with thread	50	0,035	5,49

Available while stocks last



TAB SYSTEM

POCKET SYSTEM

POCKET-TAB SYSTEM

DUO FACE SYSTEM

VELCRO SYSTEM

TOOLS WITH TANK

**MOP SYSTEM**

## Bonnet mops

### Microfiber bonnet mop



REF.	NOTES	PCK	VOLUME (m³)	GROSS WEIGHT (kg)
<b>0000D225000</b>	ø 25 cm - 10"	10	0,014	0,87
<b>6048</b>	ø 33 cm - 13"	15	0,035	4,39
<b>0000D235000</b>	ø 35 cm - 14"	15	0,035	2,17
<b>6047</b>	ø 43 cm - 17"	20	0,049	11,04
<b>0000D250000</b>	ø 50 cm - 20"	25	0,123	6,81
<b>0000D253000</b>	ø 53 cm - 21"	10	0,123	3,47

### Cotton bonnet mop



REF.	NOTES	PCK	VOLUME (m³)	GROSS WEIGHT (kg)
<b>6040</b>	ø 33 cm	10	0,028	1,83
<b>6041</b>	ø 43 cm	10	0,028	3,37

### Cotton bonnet mop, double sided



REF.	NOTES	PCK	VOLUME (m³)	GROSS WEIGHT (kg)
<b>6042</b>	ø 33 cm	10	0,025	2,6
<b>6043</b>	ø 43 cm	30	0,123	16,51



# Mop soaking systems



Mop soaking on demand  
and pre-soaking system



## WHY CHOOSE A MOP SOAKING SYSTEM?

### Advantages:

- **Reduced risks of bacterial cross-contamination:** always clean detergent solution and use of one mop for each room
- **Environmentally friendly:** higher control of chemical solution with reduced chemical and water waste, lower environmental impact if compared with traditional mopping systems employing bucket and mop
- **Better ergonomics:** no rinsing and wringing; consequently, less effort for the operator and reduced costs for industrial accidents and illness leaves
- **Easy to use:** simple to use, systems that make it easier to train the staff
- **Reduced costs for cleaning:** reduced working hours guarantee reduced labour costs
- **Excellent results in cleaning and hygiene:** thanks to the combination of mop soaking system and microfiber

## MOP SOAKING SYSTEMS

### 1 Mop soaking system on demand:

Single mop soaking on demand directly on the trolley by means of the specific Equodose dosing station.

### 2 Pre-soaking system:

Pre-soaking system in advance, preparing the mops before use, normally in specific places, employing hermetic **Top-Down®** buckets or **plastic drawers**.



EQUODOSE system



TOP-DOWN® system



System with drawers

## COMPATIBILITY

Filmop mop soaking systems fit:



Velcro system



Pocket mop system



Duo Face system

### Mop soaking system on demand

### Pre-soaking system



Alpha



Vega Top-Down®



Arka Top-Down®



Morgan Top-Down®



Alpha



## MOP SOAKING ON DEMAND AND PRE-SOAKING SYSTEM

# EQUODOSE®

PATENT PENDING



**Equodose** is the innovating **mechanical dosing device** developed by Filmop to make the **mop soaking on demand** directly on site. This system is designed with an **adjustable dosing mechanism** according to the features of the mops to use and the surfaces to clean.



### Features:

- **Totally mechanical and without electrical parts:** dosage is regulated by means of a graduated dial and operated thanks to a hand lever.
- **Strong and easy to maintain:** made of high quality polypropylene (Made in Italy), easy and low maintenance is required.
- **Safe and as by law enacted:** the graduated dial and tank can be blocked with the specific safety key device to avoid any tampering or improper use; hand level with push button to block the solution dispensing mechanism.
- **Modular design:** available with 1 or 2 tanks to increase the dosing system autonomy or to operate with two different detergents/cleaning solutions at the same time.
- **Versatile:** fitting Alpha line of trolleys. Suitable for several kinds of mops and mop holders: velcro system, pocket mop system and Duo Face mop system (only fitting 40 cm mop systems).

### Advantages:

- **Prompt and ready in the working place:** mop soaking on demand and directly on site, just the necessary mops, even one single mop!
- **Minimum overall dimensions:** ideal in environments where there is a lack of big spaces to prepare and stock the pre-soaked mops and the hermetic buckets.
- **Eco-friendly product, low environmental impact:** water and detergent saving, as this system allows to soak only the necessary mops, eliminating any unnecessary washing of unused reserve mops in the washing machine. No need of electric power, no need of power supply, made of 100% recyclable plastic.
- **Easy to use:** just a few and simple steps and the mops are ready to use, high intuitive system.
- **Flexible:** you can regulate very accurately the right solution for each single mop according to the features of the surface to clean, the degree of dirt and the absorbing capacity of the mop.
- **High standards of hygiene:** reduction of cross-contamination risks, making easy and simple to clean each room with a different and ever clean mop. Tanks preserve active principles of some chemical solutions that could become less effective over time: this system is ideal for hospitals and healthcare facilities.



## Dosing system

**Increased flexibility:** the 50 ml to 350 ml adjustable system ensures better detergent solution dosing precision also for the lightest cloths, such as surface mops for hand use, further reducing waste



## Sealed reservoir

**More effective:** hermetic tank thanks to the internal washer of the cap, better preservation of the cleaning solution

**Higher safety:** the cap locking system improves the safety level

**Better hygiene:** the reservoir design facilitates easy cleaning and good long-term maintenance



## How to use it



Rotate the graduated dial from 50 ml to 350 ml to choose the right dose of solution. If necessary, remove the safety key to lock the dial and keep the right dosage.



Push the mechanical hand lever completely down.



Take a clean mop and lay it in the tray ready for soaking with the cleaning side downwards. Wait for a few seconds for a complete and uniform mop soaking. This system is suitable for several kinds of mops, but only for 40 cm mop sizes.





## MOP SOAKING ON DEMAND AND PRE-SOAKING SYSTEM

### Equodose

**EQUODOSE** - dosing device with one tank 6 L for mop soaking on demand



REF.	NOTES	PCK	VOLUME (m³)	GROSS WEIGHT (kg)	SIZE (cm) ↓ ↓ ↓
P320100UA	with EPDM seals	1	0,09	6,01	55x28x55
P320101UA	with Viton seals	1	0,09	6,01	55x28x55

⚠ ATTENTION: only for system 40 cm

**EQUODOSE** - dosing device with two tanks 6 L for mop soaking on demand



REF.	NOTES	PCK	VOLUME (m³)	GROSS WEIGHT (kg)	SIZE (cm) ↓ ↓ ↓
P320200UA	with EPDM seals	1	0,102	7,6	55x28x55
P320201UA	with Viton seals	1	0,102	7,6	55x28x55

⚠ ATTENTION: only for system 40 cm

Transparent tank 6 L with coloured cap complete with key



REF.	NOTES	PCK	VOLUME (m³)	GROSS WEIGHT (kg)
P210017TA	with EPDM seals		10	0,139
P210017TB	with EPDM seals		10	0,139
P210022TA	with Viton seals		10	0,139
P210022TB	with Viton seals		10	0,139

Tray for mop soaking



REF.	NOTES
P110004A	

Grey plastic bucket 4 L with coloured plastic handle on the edge



REF.	NOTES	SIZE (cm) ↓ ↓ ↓
0000SE0204U		21x16,5x22,5
0000SE0204UA		21x16,5x22,5
0000SE0204UB		21x16,5x22,5
0000SE0204UC		21x16,5x22,5
0000SE0204UF		21x16,5x22,5

Transparent plastic cover with hinges



REF.	NOTES
0000CP1204T	for bucket 4 L art. 0000SE0104
0000CP1205T	for 4l bucket item no. 0000SE0204
0000CP1206T	for bucket 6 L

## MOP SOAKING ON DEMAND AND PRE-SOAKING SYSTEM

### Standard key



REF.	NOTES
P110014U	

It allows to regulate the dosage, lock the tank and close the cap

### Kit key to dose cleaning solution



REF.	NOTES
0000SM00286	

It allows to regulate the dial independently from the rest of the system with a specific key, different from the standard one - **This option enable to a single operator to adjust the right quantity of cleaning solution**

### Set for Equodose wall mounting



REF.	NOTES
0000SM00612	

## ■ Holders and mops

### Mop holder with strips 2,5 cm for velcro system



REF.	NOTES	PCK	VOLUME (m³)	GROSS WEIGHT (kg)	SIZE (cm) ↓ ↓ ↓
5263A		10	0,016	2,32	30
5259A		10	0,019	2,92	40
5260A		10	0,03	4,42	60

### Mop holder with strips 2,5 cm for velcro system and with Lock System joint



REF.	NOTES	PCK	VOLUME (m³)	GROSS WEIGHT (kg)	SIZE (cm) ↓ ↓ ↓
5359A		10	0,019	3,64	40
5360A		10	0,03	4,7	60

### Tool for 2.5 cm wide Velcro system profile mops with ErgoSwing joint



REF.	NOTES	PCK	VOLUME (m³)	GROSS WEIGHT (kg)	SIZE (cm) ↓ ↓ ↓
5959A		10	0,028	3,63	40
5960A		10	-	4,46	60

**NEW**

Use with ErgoSwing system handle, code 0000AM3045



## MOP SOAKING ON DEMAND AND PRE-SOAKING SYSTEM

### UNIKO - foldable plastic mop holder with mop fixing clip



REF.	NOTES	PCK	VOLUME (m³)	GROSS WEIGHT (kg)	SIZE (cm) ↓ ↓ ↓
0000TD0020AB		10	0,024	5,39	40x11
0000TD0010AB		10	0,035	9,14	50x13

### UNIKO - foldable plastic mop holder with mop fixing clip and Lock System



REF.	NOTES	PCK	VOLUME (m³)	GROSS WEIGHT (kg)	SIZE (cm) ↓ ↓ ↓
0000TD0320AB		10	0,024	5,69	40x11
0000TD0310AB		10	0,035	9,14	50x13

### UNIKO - plastic folding mop holder with mop head hook and ErgoSwing joint

**NEW**



REF.	NOTES	PCK	VOLUME (m³)	GROSS WEIGHT (kg)	SIZE (cm) ↓ ↓ ↓
0000TD0920AB		10	0,028	6,05	40x11
0000TD0910AB		10	-	9,08	50x13

Use with ErgoSwing system handle, code 0000AM3045

### TOP-CLEAN - plastic mop holder with grip and strips 2,5 cm for velcro system



REF.	NOTES	PCK	VOLUME (m³)	GROSS WEIGHT (kg)	SIZE (cm) ↓ ↓ ↓
5233U		10	0,016	1,98	30
5234U		10	0,019	2,1	40

### RAPIDO SUPER - high performance white ultra-microfiber mop with backing for velcro system



REF.	NOTES	PCK	VOLUME (m³)	GROSS WEIGHT (kg)	SIZE (cm) ↓ ↓ ↓
00PN0309A00DA		25	0,011	1,39	30x10
00PN0309A00DB		25	0,011	1,39	30x10
00PN0309A00DC		25	0,011	1,39	30x10
00PN0309A00DF		25	0,011	1,39	30x10
00PN0409A00DA		25	0,019	2,09	40x10
00PN0409A00DB		25	0,019	2,09	40x10
00PN0409A00DC		25	0,019	2,09	40x10
00PN0409A00DF		25	0,019	2,09	40x10
00PN0609A00DA		20	0,019	2,42	60x10
00PN0609A00DB		20	0,019	2,42	60x10
00PN0609A00DC		20	0,019	2,42	60x10
00PN0609A00DF		20	0,019	2,42	60x10



Ideal for any surface (especially the porous one) with a medium-high dirt level



## MOP SOAKING ON DEMAND AND PRE-SOAKING SYSTEM

### RAPIDO - white microfiber mop with coloured backing for velcro system



REF.	NOTES	PCK	VOLUME (m <sup>3</sup> )	GROSS WEIGHT (kg)	SIZE (cm) ↓ ↓ ↓
0000243DA		25	0,011	1,69	30x10
0000244DA		25	0,015	2,44	40x10
0000244DB		25	0,015	2,44	40x10
0000244DC		25	0,015	2,44	40x10
0000244DF		25	0,015	2,44	40x10
0000245DA		20	0,015	2,67	60x10

Ideal for any surface (especially the porous one) with a medium-high dirt level

### MICRO-ACTIVA - microfiber mop with backing for velcro system and colour-coded tags



REF.	NOTES	PCK	VOLUME (m <sup>3</sup> )	GROSS WEIGHT (kg)	SIZE (cm) ↓ ↓ ↓
0000PN02012		25	0,011	1,32	30
0000PN03012		25	0,015	1,86	40
0000PN03022		25	0,03	2,77	60

Ideal for all smooth surfaces with a medium dirt level

### PULI-SCRUB - microfiber mop with polypropylene stripes, with backing for velcro system and colour-coded tags



REF.	NOTES	PCK	VOLUME (m <sup>3</sup> )	GROSS WEIGHT (kg)	SIZE (cm) ↓ ↓ ↓
0000PN02011		25	0,011	1,49	30
0000PN03011		25	0,015	2,26	40
0000PN03021		25	0,03	3,32	60

Ideal for all rough surfaces with a medium-high dirt level- !s!\_Ideal also to remove stubborn dirt and limestone

### PULI-BRUSH - microfibre and polypropylene Velcro pad, with colour-coded label

**NEW**



REF.	NOTES	PCK	VOLUME (m <sup>3</sup> )	GROSS WEIGHT (kg)	SIZE (cm) ↓ ↓ ↓
00PN0418A00A		25	0,014	2,03	40
00PN0418A00B		25	0,014	2,03	40

Ideal for all rough surfaces with a medium-high dirt level- !s!\_Ideal also to remove stubborn dirt and limestone

### SMART-FUR - microfiber mop with backing for velcro system and colour-coded tags



REF.	NOTES	PCK	VOLUME (m <sup>3</sup> )	GROSS WEIGHT (kg)	SIZE (cm) ↓ ↓ ↓
00PN0403A00		25	0,015	1,69	40
00PN0403A00E		25	0,015	1,69	40
00PN0603A00		20	0,015	1,79	60
00PN0603A00E		20	0,015	1,79	60

Ideal for all smooth surfaces with a medium-low dirt level



## MOP SOAKING ON DEMAND AND PRE-SOAKING SYSTEM

### SMART-FUR - bordered microfiber mop with backing for velcro system and colour-coded tags



REF.	NOTES	PCK	VOLUME (m³)	GROSS WEIGHT (kg)	SIZE (cm) ↓ ↓ ↓
00PN0403H00		25	0,015	1,69	40
00PN0403H00E		25	0,015	1,69	40
00PN0603H00		20	0,015	1,79	60
00PN0603H00E		20	0,015	1,79	60



Ideal for all smooth surfaces with a low-medium dirt level - The shock-absorbing border guarantees a better protection for and against baseboards and walls

### ACTIVE-FUR - microfiber mop with nylon inserts, backing for velcro system and colour-coded tags



REF.	NOTES	PCK	VOLUME (m³)	GROSS WEIGHT (kg)	SIZE (cm) ↓ ↓ ↓
00PN0406A00		25	0,015	1,74	40
00PN0406A00E		25	0,015	1,74	40
00PN0606A00		20	0,015	2,27	60
00PN0606A00E		20	0,015	2,27	60

Ideal for all smooth surfaces with a medium dirt level

### ACTIVE-FUR - bordered microfiber mop with nylon inserts, backing for velcro system and colour-coded tags



REF.	NOTES	PCK	VOLUME (m³)	GROSS WEIGHT (kg)	SIZE (cm) ↓ ↓ ↓
00PN0406H00		25	0,015	1,74	40
00PN0406H00E		25	0,015	1,74	40
00PN0606H00		20	0,015	2,27	60
00PN0606H00E		20	0,015	2,27	60



Ideal for all smooth surfaces with a medium dirt level - The shock-absorbing border guarantees a better protection for and against baseboards and walls

### SKILL-FUR - striped microfiber mop with backing for velcro system and colour-coded tags

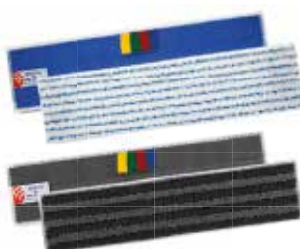

REF.	NOTES	PCK	VOLUME (m³)	GROSS WEIGHT (kg)	SIZE (cm) ↓ ↓ ↓
00PN0413A00		25	0,015	1,34	40
00PN0413A00E		25	0,015	1,34	40
00PN0613A00		20	0,015	1,91	60
00PN0613A00E		20	0,015	1,91	60

Ideal for all smooth or rough surfaces with a medium dirt level



## MOP SOAKING ON DEMAND AND PRE-SOAKING SYSTEM

### SKILL-FUR - striped bordered microfiber mop, backing for velcro system and colour-coded tags



REF.	NOTES	PCK	VOLUME (m³)	GROSS WEIGHT (kg)	SIZE (cm) ↓ ↓ ↓
00PN0413H00		25	0,015	1,34	40
00PN0413H00E		25	0,015	1,34	40
00PN0613H00		20	0,015	1,91	60
00PN0613H00E		20	0,015	1,91	60



Ideal for all smooth or rough surfaces with a medium dirt level - The shock-absorbing border guarantees a better protection for and against baseboards and walls

### ENERGY-FUR - white microfiber mop with blue stripes and abrasive, with backing for velcro system and colour-coded tags



REF.	NOTES	PCK	VOLUME (m³)	GROSS WEIGHT (kg)	SIZE (cm) ↓ ↓ ↓
00PN0411A00		25	0,015	14,19	40
00PN0611A00		20	0,015	2,11	60

Ideal for all smooth surfaces with a medium dirt level

### ENERGY-FUR - bordered white microfiber mop with blue stripes and abrasive, backing for velcro system and colour-coded tags



REF.	NOTES	PCK	VOLUME (m³)	GROSS WEIGHT (kg)	SIZE (cm) ↓ ↓ ↓
00PN0411H00		25	0,015	1,59	40
00PN0611H00		20	0,015	2,11	60



Ideal for all smooth surfaces with a medium dirt level - The shock-absorbing border guarantees a better protection for and against baseboards and walls

### Microfiber pocket mop, polyester backing, looped yarn



REF.	NOTES	PCK	VOLUME (m³)	GROSS WEIGHT (kg)	SIZE (cm) ↓ ↓ ↓
0000311D	for 40 x 11 cm mop holders	25	0,028	4,43	40x13
0000511D	for mop holders 50 x 13 cm	25	0,043	5,58	50x16

Ideal for any surface (especially the porous one) with a medium-high dirt level

### Coloured microfiber pocket mop, polyester backing, looped yarn



REF.	NOTES	PCK	VOLUME (m³)	GROSS WEIGHT (kg)	SIZE (cm) ↓ ↓ ↓
0000311AA	for 40 x 11 cm mop holders	25	0,028	4,68	40x13
0000311BB	for 40 x 11 cm mop holders	25	0,028	4,68	40x13
0000311CC	for 40 x 11 cm mop holders	25	0,028	4,68	40x13
0000311FF	for 40 x 11 cm mop holders	25	0,028	4,68	40x13



## MOP SOAKING ON DEMAND AND PRE-SOAKING SYSTEM

### MICRO-ACTIVA - microfibre mop, polyester backing, with pockets and colour-coded tag



REF.	NOTES	PCK	VOLUME (m <sup>3</sup> )	GROSS WEIGHT (kg)	SIZE (cm) ↓ ↓ ↓
0000PN04012	for 40 x 11 cm mop holders	25	0,015	2,61	40x13
0000PN06012	for mop holders 50 x 13 cm	25	0,03	3,72	50x16

Ideal for all smooth surfaces with a medium dirt level

### SPEEDY PULI-SCRUB microfibre and polypropylene mop, polyester backing, pockets and colour-coded tag



REF.	NOTES	PCK	VOLUME (m <sup>3</sup> )	GROSS WEIGHT (kg)	SIZE (cm) ↓ ↓ ↓
0000PN04011	for 40 x 11 cm mop holders	25	0,024	3,49	40x13

Ideal for all rough surfaces with a medium-high dirt level- |s|\_Ideal also to remove stubborn dirt and limestone

### PULI-BRUSH - microfibre and polypropylene mop, polyester backing, pockets and colour-coded tag

**NEW**



REF.	NOTES	PCK	VOLUME (m <sup>3</sup> )	GROSS WEIGHT (kg)	SIZE (cm) ↓ ↓ ↓	
00PN0418B00A	for 40 x 11 cm mop holders		25	0,028	2,88	40x13
00PN0418B00B	for 40 x 11 cm mop holders		25	0,028	2,88	40x13

Ideal for all rough surfaces with a medium-high dirt level- |s|\_Ideal also to remove stubborn dirt and limestone

### SMART-FUR - microfibre mop with polyester backing, pockets and colour-coded tags



REF.	NOTES	PCK	VOLUME (m <sup>3</sup> )	GROSS WEIGHT (kg)	SIZE (cm) ↓ ↓ ↓	
00PN0403B00	for 40 x 11 cm mop holders		25	0,025	3,2	40x13
00PN0403B00E	for 40 x 11 cm mop holders		50	0,056	6,48	40x13
00PN0503B00	for mop holders 50 x 13 cm		50	0,055	7,2	50x16
00PN0503B00E	for mop holders 50 x 13 cm		25	0,055	4,7	50x16

Ideal for all smooth surfaces with a medium-low dirt level

### ACTIVE-FUR - microfibre mop with nylon inserts, polyester backing, pockets and colour-coded tags



REF.	NOTES	PCK	VOLUME (m <sup>3</sup> )	GROSS WEIGHT (kg)	SIZE (cm) ↓ ↓ ↓	
00PN0406B00	for 40 x 11 cm mop holders		25	0,025	3	40x13
00PN0406B00E	for 40 x 11 cm mop holders		25	0,025	3	40x13
00PN0506B00	for mop holders 50 x 13 cm		25	0,03	4,13	50x16
00PN0506B00E	for mop holders 50 x 13 cm		25	0,03	3,75	50x16

Ideal for all smooth surfaces with a medium dirt level

## MOP SOAKING ON DEMAND AND PRE-SOAKING SYSTEM

### ENERGY-FUR - striped microfiber mop with polyester backing, pockets and colour-coded tags



REF.	NOTES	PCK	VOLUME (m <sup>3</sup> )	GROSS WEIGHT (kg)	SIZE (cm) ↓ ↓ ↓
00PN0413B00	for 40 x 11 cm mop holders	50	0,056	5,78	40x13
00PN0413B00E	for 40 x 11 cm mop holders	50	0,056	5,78	40x13
00PN0513B00	for mop holders 50 x 13 cm	25	0,03	3,96	50x16
00PN0513B00E	for mop holders 50 x 13 cm	25	0,03	3,5	50x16

Ideal for all smooth or rough surfaces with a medium dirt level

### ENERGY-FUR - white microfiber mop with blue stripes and abrasive, polyester backing, pockets and colour-coded tags



REF.	NOTES	PCK	VOLUME (m <sup>3</sup> )	GROSS WEIGHT (kg)	SIZE (cm) ↓ ↓ ↓
00PN0411B00	for 40 x 11 cm mop holders	50	0,056	6,28	40x13
00PN0511B00	for mop holders 50 x 13 cm	50	0,055	8,2	50x16

Ideal for all smooth surfaces with a medium dirt level

## Buckets and drawers for pre-soaking system

### TOP-DOWN® - plastic bucket with plastic handle and hermetic cover



REF.	NOTES	CAPACITY (L)	PCK	VOLUME (m <sup>3</sup> )	GROSS WEIGHT (kg)	SIZE (cm) ↓ ↓ ↓
0000SE1308A		8	5	0,043	3,5	36x17x23
0000SE1308B		8	5	0,043	3,5	36x17x23
0000SE1308C		8	5	0,043	3,5	36x17x23
0000SE1310A		10	5	0,094	7,45	55x24x19
0000SE1310B		10	5	0,094	7,45	55x24x19
0000SE1314A		14	4	0,086	6,63	77x20x18
0000SE1314B		14	4	0,086	6,63	77x20x18
0000SE1314FT		14	4	0,086	6,63	77x20x18
0000SE1322A		20	4	0,094	6,93	55x24x27
0000SE1322B		20	4	0,094	6,93	55x24x27
0000SE1322U		20	4	0,094	6,93	55x24x27



### Plastic divider for Top-Down® bucket 20 L

REF.	NOTES	PCK	VOLUME (m <sup>3</sup> )	GROSS WEIGHT (kg)
P190350E		5	0,024	2,67



The specific plastic reducer is ideal to keep the mop compact inside the bucket and to make it easier to pick up them from the bucket directly with the mop holder





## MOP SOAKING ON DEMAND AND PRE-SOAKING SYSTEM

### Pierced plastic sieve for Top-Down® bucket

REF.	NOTES	PCK	VOLUME (m³)	GROSS WEIGHT (kg)	SIZE (cm) ↓ ↓ ↓
<b>P1190041U</b>	for Top-Down® 8 L	9	-	1,52	33,3x14,2x2,2
<b>P1190042U</b>	for Top-Down® 10 and 20 L	10	0,031	4,24	54x20x3



Ideal for a uniform distribution of the cleaning solution - For a quick pre-soaking (max 15 minutes)

### Plastic sliding drawer without locking key

REF.	NOTES	CAPACITY (L)	PCK	VOLUME (m³)	GROSS WEIGHT (kg)	SIZE (cm) ↓ ↓ ↓
<b>P1229909U</b>	internal dimensions 41x34x9,5 cm	10	14	0,181	13,6	46,5x37,5x11
<b>P1229906U</b>	internal dimensions 40,5x34x16 cm	22	12	0,181	16,11	46,5x37,5x17



### Pierced plastic sieve for mop soaking fitting drawers 10, 22 and 40 L

REF.	NOTES	PCK	VOLUME (m³)	GROSS WEIGHT (kg)
<b>P1909925U</b>		10	0,038	5,69



Ideal for a uniform distribution of the cleaning solution - For a quick pre-soaking (max 15 minutes)

### Pierced plastic sieve with high border for mop soaking fitting drawers 10, 22 and 40 L

REF.	NOTES
<b>P1909961U</b>	



Ideal for a uniform distribution of the cleaning solution - For a quick pre-soaking (max 15 minutes)

## MOP SOAKING ON DEMAND AND PRE-SOAKING SYSTEM

Plastic cover for drawers 10, 22 and 40 L

REF.	NOTES	PCK	VOLUME (m <sup>3</sup> )	GROSS WEIGHT (kg)
<b>P1909933U</b>		10	0,038	7,21



## Trolley for the buckets transport

**POCKET** - foldable metal trolley for Top-Down® buckets 10 and 20 L

REF.	NOTES	PCK	VOLUME (m <sup>3</sup> )	GROSS WEIGHT (kg)
<b>V2030122</b>		10	0,07	14



Rilsan coated trolley for Top-Down® buckets 10 and 20 L, with wheels ø 170 mm

REF.	NOTES	PCK	VOLUME (m <sup>3</sup> )	GROSS WEIGHT (kg)
<b>R2030120</b>		2	0,21	8,06



Fitting Morgan trolleys art. 0000MP8010A and 0000MP8020A

Square Rilsan trolley with 200mm ø wheels, plastic support, trolley retaining set and Bis hook, for 10- and 20-litre Top-Down|a|@|a|a| buckets

REF.	NOTES	PCK	VOLUME (m <sup>3</sup> )	GROSS WEIGHT (kg)	SIZE (cm) ↓ ↓ ↓
<b>R3030133</b>		2	0,21	11,3	60x32x94



Fitting Alpha trolleys



## MOP SOAKING ON DEMAND AND PRE-SOAKING SYSTEM

### Accessories

**KIT BAGGY** - dustpan with rubber profile, floor squeegee with rubber blade and no. 10 bags 50x60 cm



REF.	NOTES	PCK	VOLUME (m <sup>3</sup> )	GROSS WEIGHT (kg)
0000PA20400		6	0,067	6,1



**KIT BAGGY** - dustpan with rubber profile, floor squeegee with rubber blade and no.10 bags 50x60 cm



REF.	NOTES	PCK	VOLUME (m <sup>3</sup> )	GROSS WEIGHT (kg)
0000PA20300		6	0,067	6,1

Set of 10 bags 50x60 cm for Baggy dustpan



REF.	NOTES	PCK	VOLUME (m <sup>3</sup> )	GROSS WEIGHT (kg)
SAC025		80	0,04	13,76

Graduated plastic jar



REF.	NOTES	PCK	VOLUME (m <sup>3</sup> )	GROSS WEIGHT (kg)
P191000T	3 L	12	0,073	2,96
P192000T	0,5 L	80	-	3,84



## Glass and surface cleaning line

- Window washers
- Window squeegees
- Telescopic poles
- Brilliant system
- Equipment for glass cleaning
- Hand dusters
- Cloths - Touch Line
- Top-Clean system



**WINDOW WASHERS**

WINDOW SQUEEGEES

TELESCOPIC POLES

BRILLIANT SYSTEM

EQUIPMENT FOR GLASS CLEANING

HAND DUSTERS

CLOTHS-TOUCH LINE

TOP-CLEAN SYSTEM

## Window washers and replacements

### Window washer with fixed plastic support



REF.	NOTES	PCK	VOLUME (m³)	GROSS WEIGHT (kg)	SIZE (cm) ↓ ↓ ↓
9101		12	0,025	1,89	25
9102		12	0,033	2,41	35
9103		12	0,041	2,7	45
9104		12	0,04	3	55

### Long yarn window washer with fixed plastic support



REF.	NOTES	PCK	VOLUME (m³)	GROSS WEIGHT (kg)	SIZE (cm) ↓ ↓ ↓
9501		12	0,025	1,89	25
9502		12	0,033	2,38	35
9503		12	0,041	2,7	45
9504		12	0,04	3	55

### Window washer with pad, fixed plastic support



REF.	NOTES	PCK	VOLUME (m³)	GROSS WEIGHT (kg)	SIZE (cm) ↓ ↓ ↓
9131		12	0,025	1,79	25
9132		12	0,033	2,55	35
9133		12	0,041	3,06	45
9134		12	0,043	3,38	55

### Long yarn window washer with abrasive fiber and fixed plastic support



REF.	NOTES	PCK	VOLUME (m³)	GROSS WEIGHT (kg)	SIZE (cm) ↓ ↓ ↓
9531		12	0,025	1,79	25
9532		12	0,033	2,55	35
9533		12	0,041	3,06	45
9534		12	0,043	3,38	55

### Striped window washer with long yarn complete with fixed plastic support



REF.	NOTES	PCK	VOLUME (m³)	GROSS WEIGHT (kg)	SIZE (cm) ↓ ↓ ↓
9301		12	0,02	2,11	25
9302		12	0,03	2,43	35
9303		12	0,04	2,75	45

### Striped window washer with long yarn and abrasive pad, complete with fixed plastic support



REF.	NOTES	PCK	VOLUME (m³)	GROSS WEIGHT (kg)	SIZE (cm) ↓ ↓ ↓
9331		12	0,02	2,11	25
9332		12	0,03	2,43	35
9333		12	0,04	2,75	45

### Polypropylene fixed support for window washer



REF.	NOTES	PCK	VOLUME (m³)	GROSS WEIGHT (kg)	SIZE (cm) ↓ ↓ ↓
9141		25	0,025	2,55	25
9142		25	0,033	3,06	35
9143		25	0,041	3,84	45
9144		25	0,043	4,13	55

**WINDOW WASHERS**

WINDOW SQUEEGEES

TELESCOPIC POLES

BRILLIANT SYSTEM

EQUIPMENT FOR GLASS CLEANING

HAND DUSTERS

CLOTHS-TOUCH LINE

TOP-CLEAN SYSTEM

## Aluminium jointed support for window washer



REF.	NOTES	PCK	VOLUME (m³)	GROSS WEIGHT (kg)	SIZE (cm) ↓ ↓ ↓
9161		25	0,025	3,15	25
9162		25	0,033	3,96	35
9163		25	0,041	4,29	45

## Polyester window washer replacement



REF.	NOTES	PCK	VOLUME (m³)	GROSS WEIGHT (kg)	SIZE (cm) ↓ ↓ ↓
9105		25	0,018	1,32	25
9106		25	0,024	1,63	35
9107		25	0,03	1,94	45
9108		25	0,043	2,58	55

## Polyester long yarn window washer replacement



REF.	NOTES	PCK	VOLUME (m³)	GROSS WEIGHT (kg)	SIZE (cm) ↓ ↓ ↓
9505		25	0,018	1,32	25
9506		25	0,024	1,63	35
9507		25	0,03	1,94	45
9508		25	0,043	2,58	55

## Polyester window washer replacement with pad



REF.	NOTES	PCK	VOLUME (m³)	GROSS WEIGHT (kg)	SIZE (cm) ↓ ↓ ↓
9135		25	0,018	1,57	25
9136		25	0,024	1,88	35
9137		25	0,03	2,19	45
9138		25	0,043	3,13	55

## Polyester long yarn window washer replacement with abrasive fiber



REF.	NOTES	PCK	VOLUME (m³)	GROSS WEIGHT (kg)	SIZE (cm) ↓ ↓ ↓
9535		25	0,018	1,57	25
9536		25	0,024	1,88	35
9537		25	0,03	2,19	45
9538		25	0,043	3,13	55

## Striped window washer replacement with long yarn, polyamide and acrylic



REF.	NOTES	PCK	VOLUME (m³)	GROSS WEIGHT (kg)	SIZE (cm) ↓ ↓ ↓
9305		25	0,02	1,35	25
9306		25	0,024	1,63	35
9307		25	0,03	1,94	45
9308		25	0,03	2,3	55

## Striped window washer replacement with long yarn, polyamide and acrylic, with abrasive pad



REF.	NOTES	PCK	VOLUME (m³)	GROSS WEIGHT (kg)	SIZE (cm) ↓ ↓ ↓
9335		25	0,02	1,35	25
9336		25	0,02	1,67	35
9337		25	0,03	1,99	45



WINDOW WASHERS | 
 WINDOW SQUEEGEES | 
 TELESCOPIC POLES | 
 BRILLIANT SYSTEM | 
 EQUIPMENT FOR GLASS CLEANING | 
 HAND DUSTERS | 
 CLOTHS- TOUCH LINE | 
 TOP-CLEAN SYSTEM

## TERGIVELLO - window washer squeegee complete



REF.	NOTES	PCK	VOLUME (m³)	GROSS WEIGHT (kg)	SIZE (cm) ↓ ↓ ↓
9113		10	0,019	1,7	20
9119		20	0,038	5,3	30

## Window washer replacement for Tergivello



REF.	NOTES	PCK	VOLUME (m³)	GROSS WEIGHT (kg)	SIZE (cm) ↓ ↓ ↓
9145		10	0,005	0,35	20
9146		10	0,037	0,45	30

## AMBO - window washer squeegee complete



REF.	NOTES	PCK	VOLUME (m³)	GROSS WEIGHT (kg)	SIZE (cm) ↓ ↓ ↓
9150		10	0,038	2,8	30

## Window washer replacement for Ambo



REF.	NOTES	PCK	VOLUME (m³)	GROSS WEIGHT (kg)	SIZE (cm) ↓ ↓ ↓
9149		10	0,046	0,16	30

## Window squeegees and replacements

### Stainless steel window squeegee, Filmop line



REF.	NOTES	PCK	VOLUME (m³)	GROSS WEIGHT (kg)	SIZE (cm) ↓ ↓ ↓
9251		10	0,004	1,9	25
9255		10	0,004	2,02	30
9252		10	0,004	2,16	35
9256		10	0,004	1,36	40
9253		10	0,004	2,46	45
9257		10	0,006	2,66	50
9254		10	0,006	2,8	55

### Stainless steel grip for window squeegee, Filmop line



REF.	NOTES	PCK	VOLUME (m³)	GROSS WEIGHT (kg)
9261		10	0,004	1,32

### Ergonomic stainless steel grip for window squeegee, Filmop line



REF.	NOTES	PCK	VOLUME (m³)	GROSS WEIGHT (kg)
9361		10	0,005	1,1



WINDOW WASHERS

**WINDOW SQUEEGEES**

TELESCOPIC POLES

BRILLIANT SYSTEM

EQUIPMENT FOR GLASS CLEANING

HAND DUSTERS

CLOTHS-TOUCH LINE

TOP-CLEAN SYSTEM

## Stainless steel channel with rubber blade for window squeegee, Filmop line

REF.	NOTES	PCK	VOLUME (m³)	GROSS WEIGHT (kg)	SIZE (cm) ↓ ↓ ↓
9263		25	0,002	1,7	25
9267		25	0,004	2	30
9264		25	0,004	2,5	35
9268		25	0,005	3,05	40
9265		25	0,005	3,3	45
9269		25	0,007	3,25	50
9266		25	0,007	3,75	55

## Rubber blade for window squeegee, Filmop line

REF.	NOTES	PCK	VOLUME (m³)	GROSS WEIGHT (kg)	SIZE (cm) ↓ ↓ ↓
9271		10	0,001	0,62	92
9272		10	0,001	0,49	71

## Stainless steel window squeegee

REF.	NOTES	PCK	VOLUME (m³)	GROSS WEIGHT (kg)	SIZE (cm) ↓ ↓ ↓
9051		10	0,004	1,92	25
9055		10	0,004	2,12	30
9052		10	0,004	2,22	35
9056		10	0,004	2,32	40
9053		10	0,004	2,52	45
9057		10	0,005	2,5	50
9054		10	0,006	2,78	55

## Stainless steel grip for window squeegee

REF.	NOTES	PCK	VOLUME (m³)	GROSS WEIGHT (kg)
9061		10	0,004	1,32

## Stainless steel channel with rubber blade for window squeegee

REF.	NOTES	PCK	VOLUME (m³)	GROSS WEIGHT (kg)	SIZE (cm) ↓ ↓ ↓
9063		25	0,002	1,7	25
9067		25	0,004	2	30
9064		25	0,004	2,25	35
9068		25	0,015	2,75	40
9065		25	0,005	3,3	45
9069		25	0,005	3,25	50
9066		25	0,005	3,5	55

## Jointed window squeegee support

REF.	NOTES	PCK	VOLUME (m³)	GROSS WEIGHT (kg)	SIZE (cm) ↓ ↓ ↓
9351		10	0,006	1,32	25
9355		10	0,006	1,62	30
9352		10	0,006	2,02	35
9356		10	0,006	2,12	40
9353		10	0,006	2,32	45
9357		10	0,006	2,62	50
9354		10	0,006	2,92	55





WINDOW WASHERS

**WINDOW SQUEEGEES**

**TELESCOPIC POLES**

BRILLIANT SYSTEM

EQUIPMENT FOR GLASS CLEANING

HAND DUSTERS

CLOTHS-TOUCH LINE

TOP-CLEAN SYSTEM

## Jointed grip for window squeegee



REF.	NOTES	PCK	VOLUME (m³)	GROSS WEIGHT (kg)
9461		10	0,006	1,02

## Plastic window squeegee



REF.	NOTES	PCK	VOLUME (m³)	GROSS WEIGHT (kg)	SIZE (cm) ↓ ↓ ↓
9058		10	0,006	1,3	25
9059		10	0,006	1,36	35
9060		10	0,006	1,53	45

## Stainless steel channel with rubber blade for plastic window squeegee



REF.	NOTES	PCK	VOLUME (m³)	GROSS WEIGHT (kg)	SIZE (cm) ↓ ↓ ↓
9075		25	-	1,75	25
9076		25	0,004	2,5	35
9077		25	0,005	3,2	45

## Aluminium poles

### Aluminium pole



REF.	NOTES	PCK	VOLUME (m³)	GROSS WEIGHT (kg)	SIZE (cm) ↓ ↓ ↓
9080A	1 pc x 1,25 m	10	0,019	3,35	125
0000AS21150A	1 pc x 1,5 m	10	0,024	3,96	150

### Aluminium telescopic pole - 2 pcs



REF.	NOTES	PCK	VOLUME (m³)	GROSS WEIGHT (kg)	SIZE (cm) ↓ ↓ ↓
9079A	2 pcs x 0,60 m	25	0,031	8,69	120
9081A	2 pcs x 1,25 m	10	0,033	6,67	250
9078A	2 pcs x 1,50 m	10	0,041	7,63	300
9082A	2 pcs x 2,00 m	10	0,053	9,49	400
9083A	2 pcs x 3,00 m	10	0,065	13,81	600
00059081A	2 pcs x 1,25 m	5	0,019	3,79	250
00059078A	2 pcs x 1,50 m	5	0,024	4,24	300
00059082A	2 pcs x 2,00 m	5	0,031	5,31	400
00059083A	2 pcs x 3,00 m	5	0,035	7,53	600



WINDOW WASHERS

WINDOW SQUEEGEES

**TELESCOPIC POLES**

BRILLIANT SYSTEM

EQUIPMENT FOR GLASS CLEANING

HAND DUSTERS

CLOTHS-TOUCH LINE

TOP-CLEAN SYSTEM

## Aluminium telescopic pole - 3 pcs



REF.	NOTES	PCK	VOLUME (m³)	GROSS WEIGHT (kg)	SIZE (cm) ↓ ↓ ↓
9086A	3 pcs x 1,00 m	10	0,03	8,69	300
9087A	3 pcs x 1,50 m	10	0,041	12,13	450
9084A	3 pcs x 2,00 m	10	0,053	15,41	600
9085A	3 pcs x 3,00 m	10	0,065	22,75	900
9090A	2 pcs x 4 m + 1 pc x 3 m	5	0,058	13	1100
00059086A	3 pcs x 1,00 m	5	0,019	4,68	300
00059087A	3 pcs x 1,50 m	5	0,024	7,74	450
00059084A	3 pcs x 2,00 m	5	0,031	8,15	600
00059085A	3 pcs x 3,00 m	5	0,035	12	900

## Accessories for poles

### Cranked joint for telescopic pole



REF.	NOTES
9088A	

### Blue end cone with Italian screw for telescopic pole



REF.	NOTES
9089/2A	

### Hook for telescopic pole



REF.	NOTES
9096A	

### Blue laquered wooden and metal display stand for handles and telescopic poles



REF.	NOTES	PCK	VOLUME (m³)	GROSS WEIGHT (kg)	SIZE (cm) ↓ ↓ ↓
P06000A		1	0,01	5,03	45x45x41



WINDOW WASHERS

WINDOW SQUEEGEES

TELESCOPIC POLES

**BRILLIANT SYSTEM**

EQUIPMENT FOR GLASS CLEANING

HAND DUSTERS

CLOTHS-TOUCH LINE

TOP-CLEAN SYSTEM

**Brilliant** window cleaning system is the ideal solution for the cleaning of vertical smooth surfaces like interior window cleaning, mirrors, stainless steel surfaces, lacquered surfaces, painted doors, etc.

- **Fast:** the light and handy mop holder and the ultra-microfiber mop combined with a specific alcoholic-based detergent for surfaces, guarantee shining surfaces with just one wipe
- **High performance:** thanks to its excellent features, the specific ultra-microfiber mop removes fingerprints, smears, dust particles and dirt with excellent cleaning results
- **Efficient:** the use of a flat mop holder guarantees a considerable working time reduction in comparison with traditional hand cleaning systems and a perfect adherence of the mop holder to the surface
- **Ergonomic:** a handy and ergonomic cleaning system both with mop holder with hand grip and with mop holder combined with telescopic handle to safely reach also the highest areas



GLASS AND SURFACE CLEANING LINE

## ■ Holders and cloths for Brilliant system

### TOP-CLEAN - plastic mop holder with grip and strips 2,5 cm for velcro system



REF.	NOTES	PCK	VOLUME (m³)	GROSS WEIGHT (kg)	SIZE (cm) ↓ ↓ ↓
5233U		10	0,016	1,98	30
5234U		10	0,019	2,1	40

### Mop holder with strips for velcro system with Lock System



REF.	NOTES	PCK	VOLUME (m³)	GROSS WEIGHT (kg)	SIZE (cm) ↓ ↓ ↓
5388U		10	0,016	2,34	30x8
5389U		10	0,019	3,1	40x8

### Ultra-microfiber cloths with backing for velcro system



REF.	NOTES	PCK	VOLUME (m³)	GROSS WEIGHT (kg)	SIZE (cm) ↓ ↓ ↓
0000PN02016		25	0,005	0,99	30x11
0000PN03016		25	0,011	1,49	40x11

Ideal for stainless steel surfaces, mirrors and windows

### MICRO-ACTIVA - microfiber mop with backing for velcro system and colour-coded tags



REF.	NOTES	PCK	VOLUME (m³)	GROSS WEIGHT (kg)	SIZE (cm) ↓ ↓ ↓
0000PN02012		25	0,011	1,32	30
0000PN03012		25	0,015	1,86	40
0000PN03022		25	0,03	2,77	60

Ideal for all smooth surfaces with a medium dirt level



WINDOW WASHERS

WINDOW SQUEEGEES

TELESCOPIC POLES

**BRILLIANT SYSTEM**

EQUIPMENT FOR GLASS CLEANING

HAND DUSTERS

CLOTHS- TOUCH LINE

TOP-CLEAN SYSTEM

## Kit BRILLIANT



REF.	NOTES	PCK	VOLUME (m <sup>3</sup> )	GROSS WEIGHT (kg)
<b>0000SM00619</b>		10	0,028	3,99
0000PN02016	Ultra-microfiber cloths with backing for velcro system, 30 cm			5 pcs
5233U	TOP-CLEAN - plastic mop holder with grip and strips 2,5 cm for velcro system			1 pc.

Standard cleaning kit for easily accessible shiny surfaces

## Kit BRILLIANT PLUS



REF.	NOTES	PCK	VOLUME (m <sup>3</sup> )	GROSS WEIGHT (kg)
<b>0000SM00621</b>	Italian / English	1	0,005	0,94
<b>0000SM00632</b>	French / German	1	0,005	0,94
0000AM3090A	Telescopic anodized aluminium handle 2 pcs with grey ergonomic grip, extension from 56 till 93 cm and blue cap			1 pc.
0000PN02012	MICRO-ACTIVA - microfiber mop with backing for velcro system and colour-coded tags, 30 cm			1 pc.
0000PN02016	Ultra-microfiber cloths with backing for velcro system, 30 cm			2 pcs.
5233U	TOP-CLEAN - plastic mop holder with grip and strips 2,5 cm for velcro system			1 pc.
5388U	Mop holder 30x8 cm for velcro system with Lock System			1 pc.



Complete kit for the cleaning of shiny surfaces, easily reachable

## Accessories for Brilliant system

Anodized aluminium telescopic handle with ergonomic grip and coloured cap - 2 pcs



REF.	NOTES	PCK	VOLUME (m <sup>3</sup> )	GROSS WEIGHT (kg)	SIZE (cm) ↓ ↓ ↓
<b>0000AM3070A</b>	blue, with blue cap	10	0,02	5,18	184
<b>0000AM3070UU</b>	grey, with grey cap	10	0,02	5,18	184
<b>0000AM3070UA</b>	grey, with blue cap	10	0,02	5,18	184
<b>0000AM3070UB</b>	grey, with red cap	10	0,02	5,18	184
<b>0000AM3070UC</b>	grey, with yellow cap	10	0,02	5,18	184
<b>0000AM3070UF</b>	grey, with green cap	10	0,02	5,18	184
<b>0000AM3090A</b>	blue, with blue cap	10	0,012	2,98	93

Art. 0000AM3070 extendable from 102 to 184 cm - Art. 0000AM3090A extendable from 56 to 93 cm - External tube ø 26 mm, internal tube ø 23 mm

# Glass and surface cleaning line



WINDOW WASHERS

WINDOW SQUEEGEES

TELESCOPIC POLES

**BRILLIANT SYSTEM**

EQUIPMENT FOR GLASS CLEANING

HAND DUSTERS

CLOTHS- TOUCH LINE

TOP-CLEAN SYSTEM

Plastic carry basket complete with 3 dividers and grip



REF.	NOTES	SIZE (cm) ↓ ↓ ↓
<b>3669U</b>		32,5x25x31

Plastic carry basket with special shaped bottle holder, 2 compartments and fixed grip



REF.	NOTES	SIZE (cm) ↓ ↓ ↓
<b>3690U</b>		33,5x28,3x26

Strip for velcro system



REF.	NOTES
<b>P191085U</b>	for mop holder 30 cm long side (23,3 cm)
<b>P191077U</b>	for mop holder 30 cm short side (20 cm)
<b>P191068U</b>	for mop holder 40 cm long side (35,4 cm)
<b>P191069U</b>	for mop holder 40 cm short side(32 cm)
<b>P191071U</b>	for mop holder 60 cm long side (52,2 cm)
<b>P191070U</b>	for mop holder 60 cm short side (48,6 cm)

Round cloth star fixing clip



REF.	NOTES
<b>60062U</b>	



WINDOW WASHERS

WINDOW SQUEEGEES

TELESCOPIC POLES

BRILLIANT SYSTEM

**EQUIPMENT FOR GLASS CLEANING**

HAND DUSTERS

CLOTHS- TOUCH LINE

TOP-CLEAN SYSTEM

## Bucket for window cleaning

Plastic bucket 20 L with plastic handle



REF.	NOTES	PCK	VOLUME (m <sup>3</sup> )	GROSS WEIGHT (kg)	SIZE (cm) ↓ ↓ ↓
0000SE1222A		10	0,169	12,19	55x24x27
0000SE1222B		10	0,169	12,19	55x24x27
0000SE1222U		10	0,169	12,19	55x24x27

Plastic sieve fitting bucket trolley for wax application / window cleaning



REF.	PCK	VOLUME (m <sup>3</sup> )	GROSS WEIGHT (kg)	SIZE (cm) ↓ ↓ ↓
9206A	30	0,105	7,35	53x8x10

For window washer 35 and 40 cm

Wheel ø 50 mm



REF.	NOTES
7949	for King, Spider, Ro-cket Wheels, Prisma, Twin, Top-Down®, Pick-Up, Trend and art. 0000SE1428

## Scrapers

**CLIP** - scraper with 10 blades



REF.	NOTES	PCK	VOLUME (m <sup>3</sup> )	GROSS WEIGHT (kg)	SIZE (cm) ↓ ↓ ↓
9116		50	0,004	3,77	10x2,4

Fitting only grips art. 9061 and 9261

Blades for Clip scraper



REF.	NOTES	SIZE (cm) ↓ ↓ ↓
9117	1 pc art. 9117 = 250 blades	10x2,2x0,2

Pocket scraper without blades



REF.	NOTES	PCK	VOLUME (m <sup>3</sup> )	GROSS WEIGHT (kg)	SIZE (cm) ↓ ↓ ↓
9091		50	0,003	2,25	9,5x4,5

Blades for pocket scraper



REF.	NOTES
9095	1 pc art. 9095 = 100 blades



WINDOW WASHERS

WINDOW SQUEEGEES

TELESCOPIC POLES

BRILLIANT SYSTEM

**EQUIPMENT FOR GLASS CLEANING**

HAND DUSTERS

CLOTHS-TOUCH LINE

TOP-CLEAN SYSTEM

## Fixi clamp

**FIXI** - aluminium clamp for telescopic pole



REF.	NOTES	PCK	VOLUME (m³)	GROSS WEIGHT (kg)	SIZE (cm) ↓ ↓ ↓
9110		10	0,014	3,13	19,5x16x12

Sponge for Fixi clamp



REF.	NOTES	PCK	VOLUME (m³)	GROSS WEIGHT (kg)	SIZE (cm) ↓ ↓ ↓
9111		180	0,38	7,56	29x12x6,5

Brush for Fixi clamp



REF.	NOTES	PCK	VOLUME (m³)	GROSS WEIGHT (kg)	SIZE (cm) ↓ ↓ ↓
9112		10	0,013	2,8	23x6,4x7,3

## Window cleaning set

Window cleaning set



REF.	NOTES	PCK	VOLUME (m³)	GROSS WEIGHT (kg)	
9120		1	0,049	4,38	
0000AS23050	Telescopic pole 3 pcs X 0,50 m				1 pc.
9088A	Cranked joint for telescopic pole				1 pc.
9102	Window washer with fixed plastic support 35 cm				1 pc.
9111	Sponge for Fixi clamp				1 pc.
9114	Cobweb brush				1 pc.
9116	CLIP - scraper with 10 blades				1 pc.
9151	Floor scraper with plastic grip				1 pc.
9261	Stainless steel grip for window squeegee, Filmop line				1 pc.
9263	Stainless steel channel with rubber blade for window squeegee 25 cm, Filmop line				1 pc.
9264	Stainless steel channel with rubber blade for window squeegee 35 cm, Filmop line				1 pc.
9265	Stainless steel channel with rubber blade for window squeegee 45 cm, Filmop line				1 pc.
9271	Rubber blade for window squeegee 92 cm, Filmop line				1 pc.
TCH101240	SILKY-T - green microfiber cloth, 30x40 cm				1 pc.

## Cobweb brushes

Cobweb brush



REF.	NOTES	PCK	VOLUME (m³)	GROSS WEIGHT (kg)	SIZE (cm) ↓ ↓ ↓
9114		10	0,081	2,16	37x35
9114/1	with Italian screw	10	0,081	1,78	27x35

C-shaped cobweb brush



REF.	NOTES	PCK	VOLUME (m³)	GROSS WEIGHT (kg)	SIZE (cm) ↓ ↓ ↓
9115		15	0,049	2,25	33x12
9115/1	with Italian screw	15	0,047	1,82	24x12



WINDOW WASHERS

WINDOW SQUEEGEES

TELESCOPIC POLES

BRILLIANT SYSTEM

EQUIPMENT FOR GLASS CLEANING

**HAND DUSTERS**

CLOTHS-TOUCH LINE

TOP-CLEAN SYSTEM

## Hand duster with microfiber cloths

The innovating **Flatty** hand duster is ideal to clean all surfaces thanks to its ultra flexibility.

- **Designed to be used with multipurpose cloths** for the cleaning of surfaces, till now used only by hand.
- **The cloths are rolled up on the hand duster support** and can be fixed thanks to the specific fixing clips.
- **The width of the hand duster** allows a quick and efficient dusting operation in a few simple steps.
- Compatible with telescopic poles thanks to the removable holed hand grip; by adding the end cone, ref. P179041A, it can be used with 3-hole telescopic poles and aluminium handles.

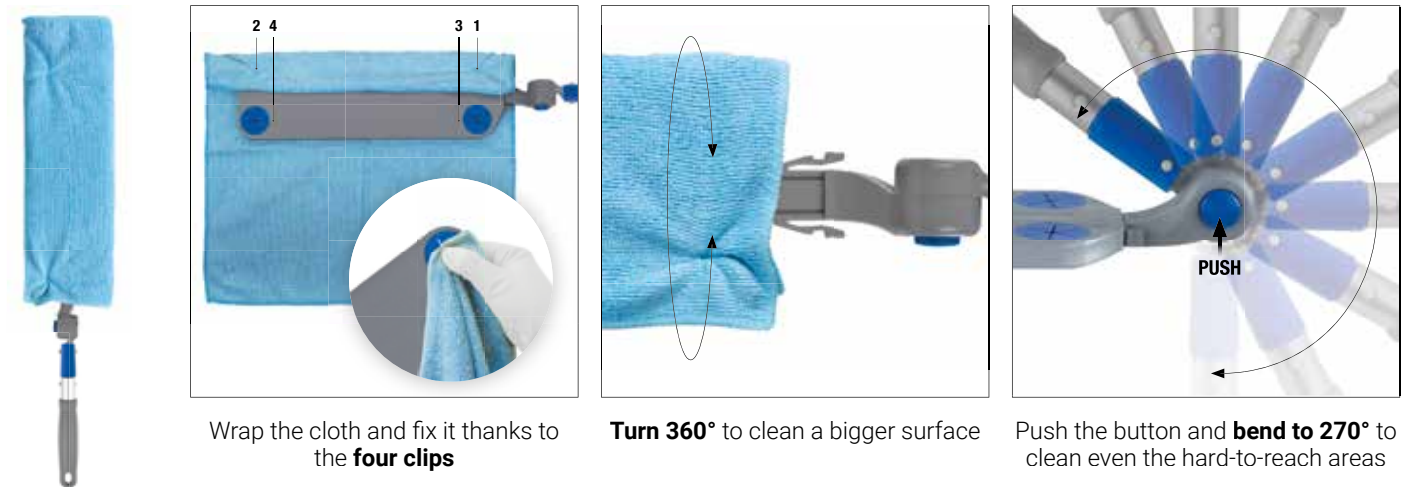

Wrap the cloth and fix it thanks to the **four clips**

**Turn 360°** to clean a bigger surface

Push the button and **bend to 270°** to clean even the hard-to-reach areas

## SNAKE: shapeable hand duster

Designed with a much more flexible and stronger plastic support, Snake can be used on both irregular and rounded surfaces for high-quality and more effective performances.

The duster is also available in the **new version** with **cloth star fixing clips** to secure disposable cloths in place, and a **practical button** at the swivel joint position, for quick frame tilting.

### Shapeable to clean both irregular and rounded surfaces



Version with screw:  
- for wooden and plastic handles  
- for poles

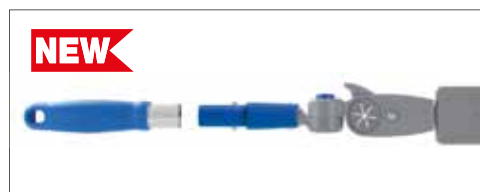

Version with hole:  
- for telescopic poles  
- for handles and aluminium handles with 3 holes, together with the end cone art. P179041A



270° rotating joint





WINDOW WASHERS

WINDOW SQUEEGEES

TELESCOPIC POLES

BRILLIANT SYSTEM

EQUIPMENT FOR GLASS CLEANING

**HAND DUSTERS**

CLOTHS-TOUCH LINE

TOP-CLEAN SYSTEM

## Spillo-Snake hand dusters

Shapable rubber mop holder with cloth fixing clips for **SNAKE** hand duster

**NEW**

REF.	NOTES	PCK	VOLUME (m <sup>3</sup> )	GROSS WEIGHT (kg)	SIZE (cm) ↓ ↓ ↓
1440A		6	0,006	1,22	40
1640A		6	0,008	2,21	60



Adaptable to telescopic poles and aluminium handles - Suitable for use with disposable cloths

Shapable polypropylene holder for hand duster **SNAKE** with grip with screw

REF.	NOTES	PCK	VOLUME (m <sup>3</sup> )	GROSS WEIGHT (kg)	SIZE (cm) ↓ ↓ ↓
1422A		6	0,006	1,88	40
1622A		6	0,008	2,42	60



Adaptable to threaded handles - Suitable for use with disposable cloths

Plastic holder for hand duster **SPILLO**

REF.	NOTES	PCK	VOLUME (m <sup>3</sup> )	GROSS WEIGHT (kg)	SIZE (cm) ↓ ↓ ↓
1400A		6	0,006	1,22	40
1600A		6	0,008	1,56	60



Adaptable to telescopic poles and aluminium handles - Suitable for use with disposable cloths

Plastic holder for hand duster **SPILLO** with grip with screw

REF.	NOTES	PCK	VOLUME (m <sup>3</sup> )	GROSS WEIGHT (kg)	SIZE (cm) ↓ ↓ ↓
1402A		6	0,006	1,43	40
1602A		6	0,008	1,78	60



Adaptable to threaded handles - Suitable for use with disposable cloths

Cone for SPILLO, SNAKE and FLATTY hand duster

REF.	NOTES
P179041A	for telescopic handle art. 0000AM3040A and aluminium handles with 3 holes



Grip with hole for SPILLO, SNAKE and FLATTY hand duster

REF.	NOTES
T121012	





WINDOW WASHERS

WINDOW SQUEEGEES

TELESCOPIC POLES

BRILLIANT SYSTEM

EQUIPMENT FOR GLASS CLEANING

**HAND DUSTERS**

CLOTHS-TOUCH LINE

TOP-CLEAN SYSTEM

Grip with screw for SPILLO and SNAKE hand duster



REF.	NOTES
P279042A	

Acrylic sleeve for hand dusters **SPILLO** and **SNAKE**



REF.	NOTES	PCK	VOLUME (m³)	GROSS WEIGHT (kg)	SIZE (cm) ↓ ↓ ↓
1084A		12	0,011	1,32	40
2084A		12	0,015	1,75	60

Microfiber sleeve for **SPILLO** and **SNAKE** hand dusters, 1 side long yarn\_1 side short yarn



REF.	NOTES	PCK	VOLUME (m³)	GROSS WEIGHT (kg)	SIZE (cm) ↓ ↓ ↓
1086		12	0,011	1,27	40
2086		12	0,015	1,71	60

Microfiber short sleeve for hand dusters **SPILLO** e **SNAKE**



REF.	NOTES	PCK	VOLUME (m³)	GROSS WEIGHT (kg)	SIZE (cm) ↓ ↓ ↓	
1085		<input type="checkbox"/>	12	0,011	1,27	40
1085A		<input checked="" type="checkbox"/>	12	0,011	0,6	40
2085		<input type="checkbox"/>	12	0,015	1,69	60
2085A		<input checked="" type="checkbox"/>	12	0,015	0,74	60

**QUIK-STIK** - Disposable cloth with glue for Spillo and Snake hand dusters

**NEW**



REF.	NOTES	PCK	VOLUME (m³)	GROSS WEIGHT (kg)	SIZE (cm) ↓ ↓ ↓
00PU0102000	Pkg: 20 polybags with 12 pcs each	1	0,034	2,26	40
00PU0102001	Pkg: 20 polybags with 12 pcs each	1	0,045	3,38	60



WINDOW WASHERS

WINDOW SQUEEGEES

TELESCOPIC POLES

BRILLIANT SYSTEM

EQUIPMENT FOR GLASS CLEANING

**HAND DUSTERS**

CLOTHS-TOUCH LINE

TOP-CLEAN SYSTEM

## Flatty hand duster

### FLATTY - plastic hand duster for microfiber cloths



REF.	NOTES	PCK	VOLUME (m <sup>3</sup> )	GROSS WEIGHT (kg)	SIZE (cm) ↓ ↓ ↓
1430		10	0,019	2,98	54x11



Fitting telescopic poles and aluminium handles - Suitable for 40x40 cm microfibre dust cloths (see the Touch cloth section)

### QUIK-STIK - Disposable cloth with glue for Flatty holder

**NEW**



REF.	NOTES	PCK	VOLUME (m <sup>3</sup> )	GROSS WEIGHT (kg)	SIZE (cm) ↓ ↓ ↓
00PU0102002	Pck: 10 polybags with 25 pcs each	1	0,038	2,73	31x38

## Fil hand duster

### FIL - acrylic hand duster in polybag



REF.	NOTES	PCK	VOLUME (m <sup>3</sup> )	GROSS WEIGHT (kg)
2012		50	0,079	6,48



WINDOW WASHERS

WINDOW SQUEEGEES

TELESCOPIC POLES

BRILLIANT SYSTEM

EQUIPMENT FOR GLASS CLEANING

HAND DUSTERS

**CLOTHS - TOUCH LINE**

TOP-CLEAN SYSTEM

Every surface risks losing its qualities and features and being irretrievably damaged, if treated with the wrong cloths. This is the reason why Filmop offers a new line of cloths and sponges: Filmop **TOUCH** line. Top quality products for the cleaning of any environment, from the floor to the most delicate surfaces. The right solution to obtain the best results in the shortest time and with the minimum effort.

**TOUCH** products are divided according to their cleaning features: **dusting, wiping** and **washing**.

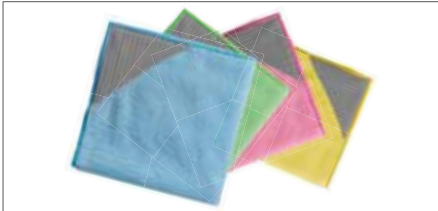

### Dusting

Cloths to use dry for a quick and daily cleaning; if dampened with water or detergents, they are advised for a deeper and more professional dusting.

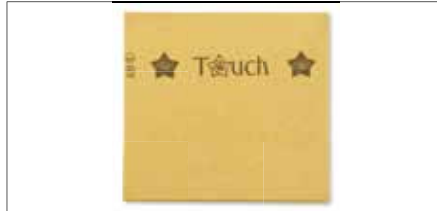

### Wiping

Special resin coated cloths to use wet for a perfect cleaning; polishing effect and quick drying of the surface.

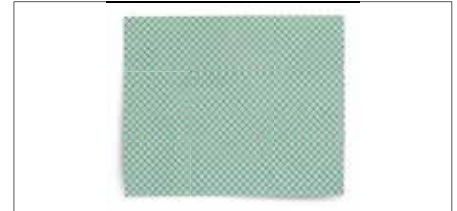

### Washing

Products with high absorbing power for a deep and intensive cleaning of big surfaces or hobs.

### Washing temperatures:



90°: Multi-T, Multi-T Maxi, Multi-T Light, Dual-T, Silky-T, Multi-T anti-bacterial, Steel-T, Profi-T



60°: Free-T, Slide-T, Cristal-T, Glass-T, Basic-T, Fast-T

### COLOUR CODE

The colour of cloths represents a shared colour-coding that identifies the area to be cleaned and how to be used, avoiding the transmission of dirt and bacteria from one cleaned surface to another one, reducing any risk of cross-contamination.



### Red cloth: very high risk

For the cleaning of bidets, WC



### Yellow cloth: high risk

Cleaning of washbasins, tiles and mirrors in bathrooms



### Green cloth: medium risk

Cleaning in kitchens, canteens and bars



### Blue cloth: low risk

For the cleaning of all surfaces, such as tables, writing desks, wardrobes, glasses

## Cloths for dusting

### DUAL-T - microfiber multipurpose cloth with scrubbing edge

REF.	NOTES		PCK	VOLUME (m <sup>2</sup> )	GROSS WEIGHT (kg)	SIZE (cm)
TCH104010			5	0,002	0,2	40x40
TCH104020			5	0,002	0,2	40x40
TCH104030			5	0,002	0,2	40x40
TCH104040			5	0,002	0,2	40x40
TCH104019	pck.: 40 polybags with 5 pcs		1	0,121	9,2	40x40
TCH104029	pck.: 40 polybags with 5 pcs		1	0,121	9,2	40x40
TCH104039	pck.: 40 polybags with 5 pcs		1	0,121	9,2	40x40
TCH104049	pck.: 40 polybags with 5 pcs		1	0,121	9,2	40x40

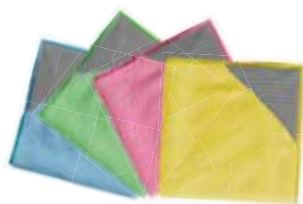

Cloth for any surface and for very dirty environments - Ideal to remove any marks and sediment deposit - Weight 250 gr/sqm

# Glass and surface cleaning line



WINDOW WASHERS

WINDOW SQUEEGEES

TELESCOPIC POLES

BRILLIANT SYSTEM

EQUIPMENT FOR GLASS CLEANING

HAND DUSTERS

**CLOTHS - TOUCH LINE**

TOP-CLEAN SYSTEM

## MULTI-T LIGHT - microfiber multipurpose cloth



REF.	NOTES	PCK	VOLUME (m <sup>3</sup> )	GROSS WEIGHT (kg)	SIZE (cm) ↓ ↓ ↓
TCH101510		20	0,007	0,6	38x38
TCH101520		20	0,007	0,6	38x38
TCH101530		20	0,007	0,6	38x38
TCH101540		20	0,007	0,6	38x38
TCH101519	pck.: 10 polybags with 20 pcs	1	0,047	6,6	38x38
TCH101529	pck.: 10 polybags with 20 pcs	1	0,047	6,6	38x38
TCH101539	pck.: 10 polybags with 20 pcs	1	0,047	6,6	38x38
TCH101549	pck.: 10 polybags with 20 pcs	1	0,047	6,6	38x38

Cloth for any surface and for very dirty environments - Resistant, it removes and keeps dirt - Weight 220 gr/sqm

## MULTI-T - microfiber multipurpose cloth



REF.	NOTES	PCK	VOLUME (m <sup>3</sup> )	GROSS WEIGHT (kg)	SIZE (cm) ↓ ↓ ↓
TCH101010		5	0,002	0,21	40x40
TCH101020		5	0,002	0,21	40x40
TCH101030		5	0,002	0,21	40x40
TCH101040		5	0,002	0,21	40x40
TCH101019	pck.: 40 polybags with 5 pcs	1	0,08	8,85	40x40
TCH101029	pck.: 40 polybags with 5 pcs	1	0,068	8,81	40x40
TCH101039	pck.: 40 polybags with 5 pcs	1	0,08	8,85	40x40
TCH101049	pck.: 40 polybags with 5 pcs	1	0,08	8,85	40x40

Cloth for any surface and for very dirty environments - Resistant, it removes and keeps dirt - Weight 250 gr/sqm

## MULTI-T MAXI - microfiber multipurpose cloth



REF.	NOTES	PCK	VOLUME (m <sup>3</sup> )	GROSS WEIGHT (kg)	SIZE (cm) ↓ ↓ ↓
TCH101120		5	0,004	0,4	50x60
TCH101129	pck.: 40 polybags with 5 pcs	1	0,079	16,38	50x60

Cloth for any surface and for very dirty environments - Resistant, soft and big size, it removes and keeps dirt - Weight 250 gr/sqm

## SILKY-T - microfiber multipurpose cloth



REF.	NOTES	PCK	VOLUME (m <sup>3</sup> )	GROSS WEIGHT (kg)	SIZE (cm) ↓ ↓ ↓
TCH101210		5	0,001	0,12	30x40
TCH101220		5	0,001	0,12	30x40
TCH101230		5	0,001	0,12	30x40
TCH101240		5	0,001	0,12	30x40
TCH101219	pck.: 48 polybags with 5 pcs	1	0,068	6,01	30x40
TCH101229	pck.: 48 polybags with 5 pcs	1	0,068	6,01	30x40
TCH101239	pck.: 48 polybags with 5 pcs	1	0,068	6,01	30x40
TCH101249	pck.: 48 polybags with 5 pcs	1	0,068	6,01	30x40

Cloth ideal for any surface - Resistant, it removes and keeps dirt, lint and smear free- Weight 200 gr/sqm



WINDOW WASHERS

WINDOW SQUEEGEES

TELESCOPIC POLES

BRILLIANT SYSTEM

EQUIPMENT FOR GLASS CLEANING

HAND DUSTERS

**CLOTHS - TOUCH LINE**

TOP-CLEAN SYSTEM

## FREE-T - Thermobounded non-woven multipurposes cloth



REF.	NOTES	PCK	VOLUME (m <sup>3</sup> )	GROSS WEIGHT (kg)	SIZE (cm) ↓ ↓ ↓
TCH601010		10	0,002	0,22	38x40
TCH601020		10	0,002	0,22	38x40
TCH601030		10	0,002	0,22	38x40
TCH601040		10	0,002	0,22	38x40
TCH601019	pck.: 20 polybags with 10 pcs	1	0,042	4,75	38x40
TCH601029	pck.: 20 polybags with 10 pcs	1	0,042	4,75	38x40
TCH601039	pck.: 20 polybags with 10 pcs	1	0,042	4,75	38x40
TCH601049	pck.: 20 polybags with 10 pcs	1	0,042	4,75	38x40

Cloth ideal to dust any surface - Half-disposable, cheap Weight 130 gr/sqm

## MULTI-T - anti-bacterial microfiber multipurpose cloth



REF.	NOTES	PCK	VOLUME (m <sup>3</sup> )	GROSS WEIGHT (kg)	SIZE (cm) ↓ ↓ ↓
TCH101410		5	0,002	0,28	40x40
TCH101420		5	0,002	0,28	40x40
TCH101430		5	0,002	0,28	40x40
TCH101440		5	0,002	0,28	40x40
TCH101419	pck.: 40 polybags with 5 pcs	1	0,08	11,6	40x40
TCH101429	pck.: 40 polybags with 5 pcs	1	0,08	11,6	40x40
TCH101439	pck.: 40 polybags with 5 pcs	1	0,08	11,6	40x40
TCH101449	pck.: 40 polybags with 5 pcs	1	0,08	11,6	40x40

With anti-bacterial treatment, it removes up to 99,98% of bacteria and fungi - Cloth for any surface and for very dirty environments - Resistant, it removes and keeps dirt - Weight: 300 gr/Sqm

## Cloths for wiping

### STEEL-T - coagulated textile wiping cloth



REF.	NOTES	PCK	VOLUME (m <sup>3</sup> )	GROSS WEIGHT (kg)	SIZE (cm) ↓ ↓ ↓
TCH401020		5	0,001	0,21	35x40
TCH401029	pck.: 20 polybags with 5 pcs	1	0,026	4,47	35x40

Cloth for glossy surfaces, chromed steel, ceramics - Anti-scaling and degreasing Weight 285 gr/sqm

### PROFI-T - non-woven ultra-microfiber cloth



REF.	NOTES	PCK	VOLUME (m <sup>3</sup> )	GROSS WEIGHT (kg)	SIZE (cm) ↓ ↓ ↓
TCH102020		5	0,001	0,1	38x40
TCH102029	pck.: 20 polybags with 5 pcs	1	0,01	2,35	38x40

Cloth for glass, glasses and delicate surfaces - Smooth-running and degreasing - Weight 100 gr/sqm



WINDOW WASHERS

WINDOW SQUEEGEES

TELESCOPIC POLES

BRILLIANT SYSTEM

EQUIPMENT FOR GLASS CLEANING

HAND DUSTERS

**CLOTHS - TOUCH LINE**

TOP-CLEAN SYSTEM

## SLIDE-T - resin coated wiping cloth



REF.	NOTES	PCK	VOLUME (m³)	GROSS WEIGHT (kg)	SIZE (cm) ↓ ↓ ↓
TCH602030		10	0,002	0,24	38x40
TCH602039	pck.: 20 polybags with 10 pcs	1	0,064	5,43	38x40

Cloth ideal for any surface - Smooth-running and bleach resistant - Weight 160 gr/sqm

## CRISTAL-T - perforated wiping cloth



REF.	NOTES	PCK	VOLUME (m³)	GROSS WEIGHT (kg)	SIZE (cm) ↓ ↓ ↓
TCH404030		10	0,002	0,31	38x40
TCH404039	pck.: 10 polybags with 10 pcs	1	0,028	3,35	38x40

Cloth for glossy surfaces - It wipes without smearing - Ideal for car cleaning - Weight: 180 gr/Sq m

## GLASS-T - ultra-microfiber wiping cloth



REF.	NOTES	PCK	VOLUME (m³)	GROSS WEIGHT (kg)	SIZE (cm) ↓ ↓ ↓
TCH103020		5	0,001	0,15	40x40
TCH103029	pck.: 40 polybags with 5 pcs	1	0,028	6	40x40

Cloth for glossy surfaces - It wipes without smearing - Ideal for glasses - Weight 200 gr/sqm

## Cloths for washing

### BASIC-T - resin coated cloth for floor washing



REF.	NOTES	PCK	VOLUME (m³)	GROSS WEIGHT (kg)	SIZE (cm) ↓ ↓ ↓
TCH603040		10	-	0,42	40x50
TCH603049	pck.: 20 polybags with 10 pcs	1	0,073	8,65	40x50

Cloth for smooth and delicate floors - Resistant and smooth-running - Weight 210 gr/sqm

### FAST-T - microfiber cloth for floor washing

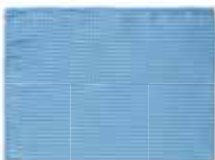

REF.	NOTES	PCK	VOLUME (m³)	GROSS WEIGHT (kg)	SIZE (cm) ↓ ↓ ↓
TCH120020		5	0,002	0,31	60x40
TCH120029	pck.: 40 polybags with 5 pcs	1	0,087	12,55	60x40

Cloth for smooth and delicate floors - Resistant and smooth-running, it removes and keeps dirt - Weight 250 gr/sqm

### INTENSIVE-T - sponge with ultra-abrasive scourer



REF.	NOTES	PCK	VOLUME (m³)	GROSS WEIGHT (kg)	SIZE (cm) ↓ ↓ ↓
TCH803000		10	-	0,18	14x9,5x3,5
TCH803009	pck.: 10 polybags with 10 pcs	1	0,053	2,37	14x9,5x3,5

Sponge for any environment - Degreasing and bleach resistant



WINDOW WASHERS

WINDOW SQUEEGEES

TELESCOPIC POLES

BRILLIANT SYSTEM

EQUIPMENT FOR GLASS CLEANING

HAND DUSTERS

CLOTHS-TOUCH LINE

**TOP-CLEAN SYSTEM**

**Top-Clean** is a cleaning system especially advised for the cleaning of desks, table-tops, tables, blackboards and walls in classrooms, schools, canteens, self-services, bars, restaurants and hotels. This mop holder combined with a traditional mop covers a wider working area than the one covered by the operator's hand using a simple cloth, thus saving time during cleaning operations; it is ergonomic and handy thanks to its grip.



## Surface cleaning with pre-soaking system



Place the 30 cm mops into the bucket with the backing support upwards.



Pour the right quantity of cleaning solution.



After 15 minutes the mops will be ready for use.



## Top-Clean holder and mops

### TOP-CLEAN - plastic mop holder with grip and strips 2,5 cm for velcro system



REF.	NOTES	PCK	VOLUME (m <sup>3</sup> )	GROSS WEIGHT (kg)	SIZE (cm) ↓ ↓ ↓
5233U		10	0,016	1,98	30
5234U		10	0,019	2,1	40

### RAPIDO - white microfiber mop with coloured backing for velcro system



REF.	NOTES	PCK	VOLUME (m <sup>3</sup> )	GROSS WEIGHT (kg)	SIZE (cm) ↓ ↓ ↓
0000243DA		25	0,011	1,69	30x10
0000244DA		25	0,015	2,44	40x10
0000244DB		25	0,015	2,44	40x10
0000244DC		25	0,015	2,44	40x10
0000244DF		25	0,015	2,44	40x10
0000245DA		20	0,015	2,67	60x10

Ideal for any surface (especially the porous one) with a medium-high dirt level





WINDOW WASHERS

WINDOW SQUEEGEES

TELESCOPIC POLES

BRILLIANT SYSTEM

EQUIPMENT FOR GLASS CLEANING

HAND DUSTERS

CLOTHS- TOUCH LINE

**TOP-CLEAN SYSTEM**

## RAPIDO SUPER - high performance white ultra-microfiber mop with backing for velcro system

REF.	NOTES	PCK	VOLUME (m <sup>2</sup> )	GROSS WEIGHT (kg)	SIZE (cm) ↓ ↓ ↓
00PN0309A00DA		25	0,011	1,39	30x10
00PN0309A00DB		25	0,011	1,39	30x10
00PN0309A00DC		25	0,011	1,39	30x10
00PN0309A00DF		25	0,011	1,39	30x10
00PN0409A00DA		25	0,019	2,09	40x10
00PN0409A00DB		25	0,019	2,09	40x10
00PN0409A00DC		25	0,019	2,09	40x10
00PN0409A00DF		25	0,019	2,09	40x10
00PN0609A00DA		20	0,019	2,42	60x10
00PN0609A00DB		20	0,019	2,42	60x10
00PN0609A00DC		20	0,019	2,42	60x10
00PN0609A00DF		20	0,019	2,42	60x10



Ideal for any surface (especially the porous one) with a medium-high dirt level

## RAPIDO - coloured microfiber mop with coloured backing for velcro system

REF.	NOTES	PCK	VOLUME (m <sup>2</sup> )	GROSS WEIGHT (kg)	SIZE (cm) ↓ ↓ ↓
0000214AA		25	0,015	2,44	40x10
0000214BB		25	0,015	2,44	40x10
0000214CC		25	0,015	2,44	40x10
0000214FF		25	0,015	2,44	40x10



## MICRO-ACTIVA - microfiber mop with backing for velcro system and colour-coded tags

REF.	NOTES	PCK	VOLUME (m <sup>2</sup> )	GROSS WEIGHT (kg)	SIZE (cm) ↓ ↓ ↓
0000PN02012		25	0,011	1,32	30
0000PN03012		25	0,015	1,86	40
0000PN03022		25	0,03	2,77	60



Ideal for all smooth surfaces with a medium dirt level

## PULI-SCRUB - microfiber mop with polypropylene stripes, with backing for velcro system and colour-coded tags

REF.	NOTES	PCK	VOLUME (m <sup>2</sup> )	GROSS WEIGHT (kg)	SIZE (cm) ↓ ↓ ↓
0000PN02011		25	0,011	1,49	30
0000PN03011		25	0,015	2,26	40
0000PN03021		25	0,03	3,32	60



Ideal for all rough surfaces with a medium-high dirt level- Ideal also to remove stubborn dirt and limestone

## Ultra-microfiber cloths with backing for velcro system

REF.	NOTES	PCK	VOLUME (m <sup>2</sup> )	GROSS WEIGHT (kg)	SIZE (cm) ↓ ↓ ↓
0000PN02016		25	0,005	0,99	30x11
0000PN03016		25	0,011	1,49	40x11



Ideal for stainless steel surfaces, mirrors and windows



# Handles and safety signs



Handles

Warning safety signs





## HANDLES

## WARNING SAFETY SIGNS



### Anodized aluminium handle:

- **Telescopic:** extension up to 184 cm
- **Ergonomic:** easy grip and use of the handle thanks to the shape and the new material of the grip
- **Non-slip:** the rubber material of the grip allows to keep the mop holder stable while cleaning any kind of wall
- **New design:** soft line and a good touch feeling material
- **With colour-coding**

**NEW**

## ErgoSwing ergonomic system

ErgoSwing is the innovative system consisting of telescopic handle with turning grip and mop holder with ergonomic joint designed for **easy S movement**.

The system guarantees **less strain** and **increased productivity**, together with better floor cleaning performance.

- **ERGONOMIC:** 360° rotation hand grips for easier movement and sturdy grip
- **SAFE:** the rotation locking mechanism allows to safely place the tool against a support
- **EFFICIENT:** the system offers optimum performance, with significantly less effort required by the operator



**PAT PENDING**

## PROVED ERGONOMICS

In the long term, repeated wrist strain can cause muscle-skeletal issues and pathologies. The ErgoSwing system usability analysis carried out by Humana Consulting demonstrates a **significant reduction in wrist bending and extension movements** when compared with traditional systems.

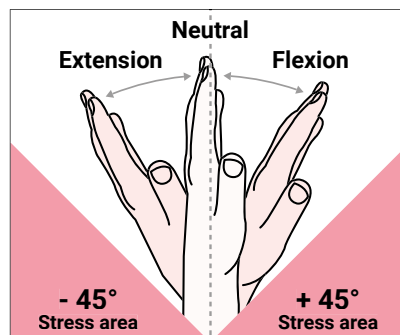

ErgoSwing allows the user to significantly remain below the maximum tolerance level (45°), therefore preventing the development of work-related illnesses.

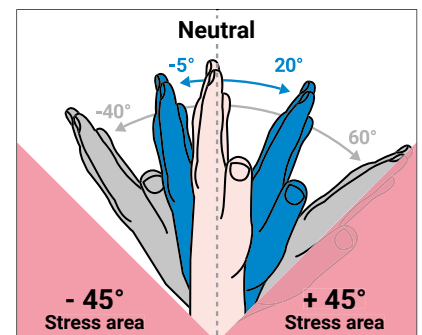

Standard systems subject the wrist to significant bending-extension movements (grey hand), while ErgoSwing allows to limit wrist movement, therefore reducing strain (blue hand).

## COMPATIBILITY

ErgoSwing is available with flaps, pockets, pockets-flaps, Velcro and blades





## HANDLES

## WARNING SAFETY SIGNS

### Aluminium telescopic handles

2-piece anodized aluminium telescopic handle for ErgoSwing system with turning grips and coloured insert

**NEW**

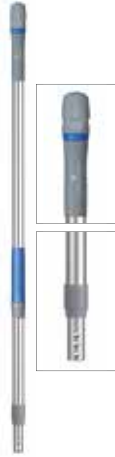

REF.	NOTES		PCK	VOLUME (m <sup>3</sup> )	GROSS WEIGHT (kg)	SIZE (cm) ↓ ↓ ↓
0000AM3045A	blue, with blue insert		10	0,021	4,8	187
0000AM3045UU	grey, with grey insert		10	0,021	4,8	187
0000AM3045UA	grey, with blue insert		10	0,021	4,8	187
0000AM3045UB	grey, with red insert		10	0,021	4,8	187
0000AM3045UC	grey, with yellow insert		10	0,021	4,8	187
0000AM3045UF	grey, with green insert		10	0,021	4,8	187

Extends from 105 to 187 cm

Anodized aluminium telescopic handle with ergonomic grip and coloured cap - 2 pcs



REF.	NOTES		PCK	VOLUME (m <sup>3</sup> )	GROSS WEIGHT (kg)	SIZE (cm) ↓ ↓ ↓
0000AM3070A	blue, with blue cap		10	0,02	5,18	184
0000AM3070UU	grey, with grey cap		10	0,02	5,18	184
0000AM3070UA	grey, with blue cap		10	0,02	5,18	184
0000AM3070UB	grey, with red cap		10	0,02	5,18	184
0000AM3070UC	grey, with yellow cap		10	0,02	5,18	184
0000AM3070UF	grey, with green cap		10	0,02	5,18	184
0000AM3090A	blue, with blue cap		10	0,012	2,98	93

Art. 0000AM3070 extendable from 102 to 184 cm - Art. 0000AM3090A extendable from 56 to 93 cm - External tube ø 26 mm, internal tube ø 23 mm

Anodized aluminium telescopic handle with ergonomic grip, blue cap and end cone with screw - 2 pcs



REF.	NOTES		PCK	VOLUME (m <sup>3</sup> )	GROSS WEIGHT (kg)	SIZE (cm) ↓ ↓ ↓
0000AM3170A	blue, with blue cap		10	0,02	5,48	184

Extendible form 102 to 184 cm - External tube ø 26 mm, internal tube ø 23 mm



## HANDLES

## WARNING SAFETY SIGNS

Anodized aluminium telescopic handle with anti-bacterial components - 2 pcs



REF.	NOTES	PCK	VOLUME (m³)	GROSS WEIGHT (kg)	SIZE (cm) ↓ ↓ ↓
0000AM3040FZ		10	0,014	4,69	182

Extendible from 100 to 182 cm - External tube ø 26 mm, internal tube ø 23 mm

2-piece telescopic anodized aluminium handle



REF.	NOTES	PCK	VOLUME (m³)	GROSS WEIGHT (kg)	SIZE (cm) ↓ ↓ ↓
0000AM3060A	Extends from 79 to 140 cm	50	0,064	23,28	140

Extends from 79 to 140 cm - External tube ø 26 mm, internal tube ø 23 mm

## Accessories for handles

Blue end cone with screw for telescopic handle ø 23 mm



REF.	NOTES
P179040A	



## HANDLES

## WARNING SAFETY SIGNS

### Plastic handles

Shaped plastic handle with Italian screw and hole

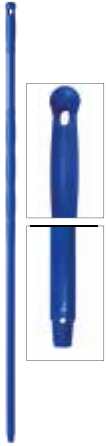

REF.	NOTES	PCK	VOLUME (m <sup>3</sup> )	GROSS WEIGHT (kg)	SIZE (cm) ↓ ↓ ↓
0000PM3000A		10	0,021	7,28	145
0000PM3000B		10	0,021	7,28	145
0000PM3000C		10	0,021	7,27	145
0000PM3000D		10	0,021	7,27	145
0000PM3000F		10	0,021	7,27	145

Available on request with different screws - Autoclavable up to 120° C - H.A.C.C.P. compliant

### Wooden handles

Varnished wooden handle ø 23 mm with Italian screw and hole

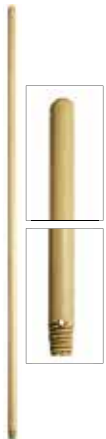

REF.	NOTES	PCK	VOLUME (m <sup>3</sup> )	GROSS WEIGHT (kg)	SIZE (cm) ↓ ↓ ↓
0000LM30023		50	0,043	11,8	130
0000LM30003		50	0,049	27,2	150

Thanks to their hole and screw, these handles can be used both with mop holders with screw and with the ones with ring

Wooden handle

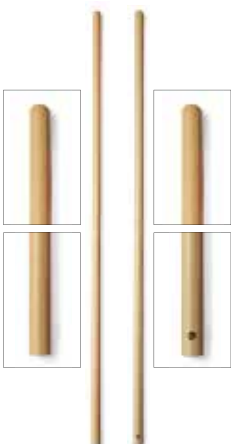

REF.	NOTES	PCK	VOLUME (m <sup>3</sup> )	GROSS WEIGHT (kg)	SIZE (cm) ↓ ↓ ↓
1057	ø 24 mm for industrial brooms	50	0,046	20	140
1070	ø 30 mm with hole for Street brooms	10	0,012	5,2	145



## HANDLES

## WARNING SAFETY SIGNS

### Chromed metal handles

Chromed metal handle with hole  $\varnothing$  22 mm - 2 pcs



REF.	NOTES	PCK	VOLUME (m <sup>3</sup> )	GROSS WEIGHT (kg)	SIZE (cm) ↓ ↓ ↓
1053A		25	0,031	16,24	140
1054		25	0,031	14,99	130

Chromed metal handle with hole  $\varnothing$  22 mm - 3 pcs



REF.	NOTES	PCK	VOLUME (m <sup>3</sup> )	GROSS WEIGHT (kg)	SIZE (cm) ↓ ↓ ↓
1063		25	0,03	15,25	130

### Aluminium handles

Anodized aluminium handle  $\varnothing$  23 mm with 3 holes, coloured grip

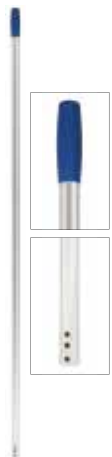

REF.	NOTES	PCK	VOLUME (m <sup>3</sup> )	GROSS WEIGHT (kg)	SIZE (cm) ↓ ↓ ↓
0000AM30025		25	0,037	7,25	130
0000AM30015		25	0,034	5,65	140
0000AM30015B		25	0,034	5,65	140
0000AM30015C		25	0,034	5,65	140
0000AM30015F		25	0,034	5,65	140
0000AM30015U		25	0,034	5,65	140
0000AM30005		25	0,038	7,75	150

The 3 holes allow the use of the handle with several and different mop holders



## HANDLES

## WARNING SAFETY SIGNS

Anodized aluminium handle ø 22 mm with plastic screw



REF.	NOTES	PCK	VOLUME (m³)	GROSS WEIGHT (kg)	SIZE (cm) ↓ ↓ ↓
0000AM30010		25	0,034	6,47	140
0000AM30020		25	0,041	5,93	130

Upon request, it is available with coloured grip

## Glass fiber handles

Glass fiber handle ø 23,5 mm with hole

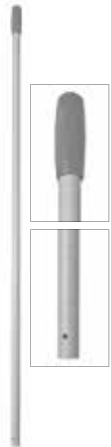

REF.	NOTES	PCK	VOLUME (m³)	GROSS WEIGHT (kg)	SIZE (cm) ↓ ↓ ↓
1069E		25	0,042	9,15	145

## Coated metal handles

Coated metal handle ø 22 mm with screw

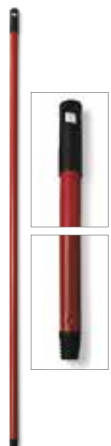

REF.	NOTES	PCK	VOLUME (m³)	GROSS WEIGHT (kg)	SIZE (cm) ↓ ↓ ↓
1059		10	0,007	2,7	130





## HANDLES

## WARNING SAFETY SIGNS

### Plastic coated metal handles

Plastic coated telescopic metal handle ø 22 mm with cone - 2 pcs

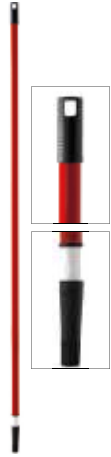

REF.	NOTES	PCK	VOLUME (m³)	GROSS WEIGHT (kg)	SIZE (cm) ↓ ↓ ↓
2015		12	0,022	9,6	300

### Handles with tank

**SPRINTER** - tank handle 500 ml

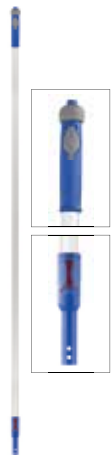

REF.	NOTES	PCK	VOLUME (m³)	GROSS WEIGHT (kg)	SIZE (cm) ↓ ↓ ↓
0000TD0400A		5	0,021	3,31	145





HANDLES

WARNING SAFETY SIGNS

## Warning safety signs

Essential working equipment for the cleaning operators, in compliance with the safety regulations in force, Filmop **warning safety signs** are completely made of plastic, light and shock-resistant. They have a very clear warning printing visible also at a long distance.

**“CAUTION” in all the languages of the world!**  
**On request safety signs available also in other languages**

HANDLES AND SAFETY SIGNS



Thanks to their special hanging system, these safety signs can be hung on any kind of multipurpose trolley reducing to the minimum the overall dimensions of the trolley.

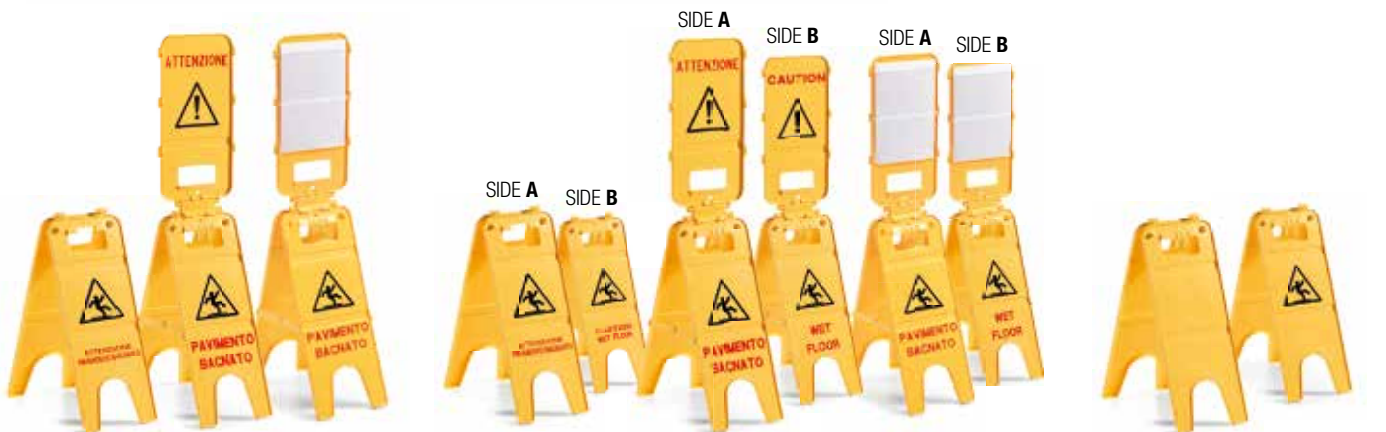

**Monolingual** safety sign with **one language** on **both sides**

**Bilingual** safety sign with **different languages** on **sides**





**Neutral** safety sign only with **graphic symbol**



## Safety signs - 2 parts and 3 parts

### Monolingual plastic safety sign "caution wet floor", 2 parts







REF.	NOTES	PCK	VOLUME (m³)	GROSS WEIGHT (kg)	SIZE (cm) ↓ ↓ ↓
<b>60068614</b>	Neutral without writing	5	0,026	4,02	23x42x57
<b>8614.0</b>	Neutral without writing but with graphic symbol	5	0,026	4,02	23x42x57
<b>8614</b>	 in <b>Italian</b> "ATTENZIONE PAVIMENTO BAGNATO"	5	0,026	4,02	23x42x57
<b>8614GB</b>	 in <b>English</b> "CAUTION WET FLOOR"	5	0,026	4,02	23x42x57
<b>8614D</b>	 in <b>German</b> "ACHTUNG RUTSCHGEFAHR"	5	0,026	4,02	23x42x57
<b>8614F</b>	 in <b>French</b> "ATTENTION SOL GLISSANT"	5	0,026	4,02	23x42x57

On request available in other languages or in bilingual version (with one different language on every side)

### Monolingual plastic safety sign "caution wet floor", 3 parts







REF.	NOTES	PCK	VOLUME (m³)	GROSS WEIGHT (kg)	SIZE (cm) ↓ ↓ ↓
<b>60068624</b>	Neutral without writing	5	0,04	6,11	23x42x104
<b>8624.0</b>	Neutral without writing but with graphic symbol	5	0,04	6,11	23x42x104
<b>8624</b>	 in <b>Italian</b> "ATTENZIONE PAVIMENTO BAGNATO"	5	0,04	6,11	23x42x104
<b>8624GB</b>	 in <b>English</b> "CAUTION WET FLOOR"	5	0,04	6,11	23x42x104
<b>8624D</b>	 in <b>German</b> "ACHTUNG RUTSCHGEFAHR"	5	0,04	6,11	23x42x104
<b>8624F</b>	 in <b>French</b> "ATTENTION SOL GLISSANT"	5	0,04	6,11	23x42x104

On request available in other languages or in bilingual version (with one different language on every side)

### Monolingual plastic safety sign "caution wet floor", 3 parts with check-list holder



REF.	NOTES	PCK	VOLUME (m³)	GROSS WEIGHT (kg)	SIZE (cm) ↓ ↓ ↓
<b>60068654</b>	Neutral without writing	4	0,04	8,36	23x42x104
<b>8654.0</b>	Neutral without writing but with graphic symbol	4	0,04	8,36	23x42x104
<b>8654</b>	 in <b>Italian</b> "PAVIMENTO BAGNATO"	4	0,04	8,36	23x42x104
<b>8654GB</b>	 in <b>English</b> "WET FLOOR"	4	0,04	8,36	23x42x104
<b>8654D</b>	 in <b>German</b> "ACHTUNG RUTSCHGEFAHR"	4	0,04	8,36	23x42x104
<b>8654F</b>	 in <b>French</b> "SOL GLISSANT"	4	0,04	8,36	23x42x104

On request available in other languages or in bilingual version (with one different language on every side)



## HANDLES

The **conical safety sign** is round shaped and has a smooth surface for an easier cleaning. The warning printing is very clear and visible on the four sides. It can be placed also outside thanks to the special weights. It can be equipped with a flashing light and several plastic boards to increase its visibility further more.

## WARNING SAFETY SIGNS



HANDLES AND SAFETY SIGNS

### Conical safety sign

Conical plastic safety sign



REF.	NOTES	PCK	VOLUME (m³)	GROSS WEIGHT (kg)	SIZE (cm)
8634	h 93 cm	5	0,183	9,27	93

### Accessories for safety signs

Plastic chain for safety sign composed of 12 elements

REF.	NOTES
P250001C	length 1 mt



Weight 0,5 kgs for conical safety sign with screws



REF.	NOTES	PCK	VOLUME (m³)	GROSS WEIGHT (kg)
A250004		30	0,008	19,56



## HANDLES

## WARNING SAFETY SIGNS

### Red flashing light for conical safety sign



REF.	NOTES	PCK	VOLUME (m <sup>3</sup> )	GROSS WEIGHT (kg)
P250002	battery power: 2 batteries 1,5 V necessary	6	0,006	0,6

### Round plastic board for conical safety sign



REF.	NOTES	PCK	VOLUME (m <sup>3</sup> )	GROSS WEIGHT (kg)	
P230001B	"no entry"		5	0,005	0,52
P230002A	"directional arrow"		5	0,005	0,52
P230003C	in Italian "ATTENZIONE PAVIMENTO BAGNATO"		5	0,005	0,52
P230GB3C	in English "CAUTION WET FLOOR"		5	0,005	0,52
P2300D3C	in German "ACHTUNG RUTSCHGEFAHR"		5	0,005	0,52
P2300F3C	in French "ATTENTION SOL MOUILLE"		5	0,005	0,52

### Rectangular plastic board for conical safety sign



REF.	NOTES	PCK	VOLUME (m <sup>3</sup> )	GROSS WEIGHT (kg)	
P240001C	in Italian "ATTENZIONE PAVIMENTO BAGNATO"		5	0,028	2
P240GB1C	in English "CAUTION WET FLOOR"		5	0,028	2
P2400D1C	in German "ACHTUNG RUTSCHGEFAHR"		5	0,028	2
P2400F1C	in French "ATTENTION SOL GLISSANT"		5	0,028	2
P240002C	in Italian "PULIZIA IN CORSO"		5	0,028	2
P240GB2C	in English "CLEANING IN PROGRESS"		5	0,028	2
P2400D2C	in German "REINIGUNGSARBEITEN"		5	0,028	2
P240003C	in Italian "FUORI SERVIZIO"		5	0,028	2
P240GB3C	in English "OUT OF SERVICE"		5	0,028	2
P2400D3C	in German "AUSSER BETRIEB"		5	0,028	2
P2400F3C	in French "HORS SERVICE"		5	0,028	2
P240004B	in Italian "CHIUSO"		5	0,028	2
P240GB4B	in English "CLOSED"		5	0,028	2
P2400D4B	in German "GESCHLOSSEN"		5	0,028	2
P2400F4B	in French "FERME"		5	0,028	2



HANDLES

WARNING SAFETY SIGNS

## New safety sign for door "Cleaning in progress":

- Ideal to stop people from entering public areas during maintenance and cleaning
- Thanks to the suction cups on both sides, the safety sign for door is stable and easily stuck, without damaging any surface
- Adaptable to 76 to 137 cm wide doors thanks to the aluminium telescopic pole.
- PVC cloth with digital printing with the possibility of graphic customizations



HANDLES AND SAFETY SIGNS

## Safety sign for door

Safety sign for door "Cleaning in progress" with suction caps

REF.	NOTES	PCK	VOLUME (m <sup>3</sup> )	GROSS WEIGHT (kg)
9310		10	0,016	4,73



Extendible from 77 to 134 cm



## Buckets and wringer trolleys

Plastic mop trolleys

Chromed and Rilsan coated trolleys

Bucket/wringer combos

Wringers

Multi-purpose buckets

Top-Down® buckets

Other plastic buckets



## **NEW** OneFred wringer trolley



OneFred is a **highly professional washing system**, now even easier to use thanks to the more ergonomic and lighter design.

- Modern design, conceived for maximum ergonomics.
- Designed to be light, compact and resistant at the same time
- Only one frame for 15 and 25 l buckets, simple and easy to assemble
- Practical and safe Alpha trolley attachment system



BUCKETS AND WRINGER TROLLEYS

### Some OneFred features



**STACKABLE FRAME**  
Volume optimization



**ERGONOMIC HAND GRIP**  
Practical and functional



**BUILT-IN BUMPERS**  
Shock proof



**STORAGE BOX**  
Wide range of accessories

### Commitment towards environmental sustainability

OneFred makes cleaning and sanitation easy, whilst also caring for the environment: being fully made of high-quality recycled plastic, the wringer trolley is **certified PSV – Plastic Second Life**.





# Buckets and wringer trolleys



PLASTIC MOP TROLLEYS

CHROMED AND RILSAN COATED TROLLEYS

BUCKET/WRINGER COMBOS

WRINGERS

MULTI-PURPOSE BUCKETS

TOP-DOWN® BUCKETS

OTHER PLASTIC BUCKETS

## OneFred trolleys

### ONEFRED - 30 L plastic trolley with Rilsan coated push-bar

NEW



REF.	PCK	VOLUME (m³)	GROSS WEIGHT (kg)	SIZE (cm) ↓ ↓ ↓
<b>0000LF1030YU</b>	1	0,176	7,76	80x41x84
0000SE0115UA	Grey plastic bucket 15 L with blue plastic handle for OneFred trolley			1 pc.
0000SE0115UB	Grey plastic bucket 15 L with red plastic handle for OneFred trolley			1 pc.
7004E	REGULAR - grey plastic down-press wringer with plastic gears			1 pc.
8730YSS	Plastic frame with ø 80 mm wheels for OneFred 30 L and 50 L			1 pc.
R8061/2	Rilsan coated push-bar ø 18 mm for OneFred			1 pc.



### ONEFRED - plastic trolley 50 L with Rilsan coated push-bar

NEW



REF.	PCK	VOLUME (m³)	GROSS WEIGHT (kg)	SIZE (cm) ↓ ↓ ↓
<b>0000LF1050YU</b>	1	0,176	7,97	82x41x84
0000SE0125UA	Grey plastic bucket 25 L with blue plastic handle for OneFred trolley			1 pc.
0000SE0125UB	Grey plastic bucket 25 L with red plastic handle for OneFred trolley			1 pc.
7004E	REGULAR - grey plastic down-press wringer with plastic gears			1 pc.
8730YSS	Plastic frame with ø 80 mm wheels for OneFred 30 L and 50 L			1 pc.
R8061/2	Rilsan coated push-bar ø 18 mm for OneFred			1 pc.



### ONEFRED - plastic trolley 30 L with plastic grip

NEW



REF.	PCK	VOLUME (m³)	GROSS WEIGHT (kg)	SIZE (cm) ↓ ↓ ↓
<b>0000LF0030YU</b>	1	0,137	6,85	65x39x87
<b>0100LF0030YU</b>	2	0,217	12,7	65x39x87
0000SE0115UA	Grey plastic bucket 15 L with blue plastic handle for OneFred trolley			1 pc.
0000SE0115UB	Grey plastic bucket 15 L with red plastic handle for OneFred trolley			1 pc.
7004E	REGULAR - grey plastic down-press wringer with plastic gears			1 pc.
8730YSS	Plastic frame with ø 80 mm wheels for OneFred 30 L and 50 L			1 pc.
8731Y	Plastic grip for OneFred trolley			1 pc.



### ONEFRED - plastic trolley 50 L with plastic grip

NEW



REF.	PCK	VOLUME (m³)	GROSS WEIGHT (kg)	SIZE (cm) ↓ ↓ ↓
<b>0000LF0050YU</b>	1	0,151	7,28	73x40x87
<b>0100LF0050YU</b>	2	0,244	13,21	73x40x87
0000SE0125UA	Grey plastic bucket 25 L with blue plastic handle for OneFred trolley			1 pc.
0000SE0125UB	Grey plastic bucket 25 L with red plastic handle for OneFred trolley			1 pc.
7004E	REGULAR - grey plastic down-press wringer with plastic gears			1 pc.
8730YSS	Plastic frame with ø 80 mm wheels for OneFred 30 L and 50 L			1 pc.
8731Y	Plastic grip for OneFred trolley			1 pc.



PLASTIC MOP TROLLEYS

CHROMED AND RILSAN COATED TROLLEYS

BUCKET/WRINGER COMBOS

WRINGERS

MULTI-PURPOSE BUCKETS

TOP-DOWN® BUCKETS

OTHER PLASTIC BUCKETS

**ONEFRED** - 30l plastic trolley with plastic handle, caddy and mop holder

**NEW**



REF.	PCK	VOLUME (m³)	GROSS WEIGHT (kg)
<b>0000LF0031YU</b>	1	0,192	7,8
0000SE0115UA	Grey plastic bucket 15 L with blue plastic handle for OneFred trolley		1 pc.
0000SE0115UB	Grey plastic bucket 15 L with red plastic handle for OneFred trolley		1 pc.
0000SM00299	Mop holder kit for OneFred trolley		1 pc.
60406Y	Plastic carry basket for OneFred		1 pc.
7004E	REGULAR - grey plastic down-press wringer with plastic gears		1 pc.
8730YSS	Plastic frame with ø 80 mm wheels for OneFred 30 L and 50 L		1 pc.
8731Y	Plastic grip for OneFred trolley		1 pc.



**ONEFRED** - 50l plastic trolley with plastic handle, caddy and mop holder

**NEW**



REF.	PCK	VOLUME (m³)	GROSS WEIGHT (kg)
<b>0000LF0051YU</b>	1	0,192	8
0000SE0125UA	Grey plastic bucket 25 L with blue plastic handle for OneFred trolley		1 pc.
0000SE0125UB	Grey plastic bucket 25 L with red plastic handle for OneFred trolley		1 pc.
0000SM00299	Mop holder kit for OneFred trolley		1 pc.
60406Y	Plastic carry basket for OneFred		1 pc.
7004E	REGULAR - grey plastic down-press wringer with plastic gears		1 pc.
8730YSS	Plastic frame with ø 80 mm wheels for OneFred 30 L and 50 L		1 pc.
8731Y	Plastic grip for OneFred trolley		1 pc.



## Fred trolleys

**FRED** - plastic trolley 30 L with painted push-bar



REF.	PCK	VOLUME (m³)	GROSS WEIGHT (kg)	SIZE (cm)
<b>7960A</b>	1	0,129	8,18	65x41x90
7004A	REGULAR - blue plastic down-press wringer with plastic gears			1 pc.
8108A	Blue plastic bucket 15 L with plastic handle			1 pc.
8108B	Red plastic bucket 15 L with plastic handle			1 pc.
8331SS	Plastic frame with wheels ø 80 mm for Fred trolley 30 L			1 pc.
R8061/1	Painted push-bar ø 18 mm for Fred trolley			1 pc.



**FRED** - plastic trolley 50 L with painted push-bar



REF.	PCK	VOLUME (m³)	GROSS WEIGHT (kg)	SIZE (cm)
<b>7965A</b>	1	0,177	9,42	69x42x90
7004A	REGULAR - blue plastic down-press wringer with plastic gears			1 pc.
8107A	Blue plastic bucket 25 L with plastic handle			1 pc.
8107B	Red plastic bucket 25 L with plastic handle			1 pc.
8332SS	Plastic frame with wheels ø 80 mm for Fred 50 L and Arka trolleys			1 pc.
R8061/1	Painted push-bar ø 18 mm for Fred trolley			1 pc.



# Buckets and wringer trolleys



PLASTIC MOP  
TROLLEYS

CHROMED AND RILSAN  
COATED TROLLEYS

BUCKET/WRINGER  
COMBOS

WRINGERS

MULTI-PURPOSE  
BUCKETS

TOP-DOWN® BUCKETS

OTHER PLASTIC  
BUCKETS

## FRED - plastic trolley 30 L with plastic grip



REF.	PCK	VOLUME (m³)	GROSS WEIGHT (kg)	SIZE (cm) ↓ ↓ ↓
<b>7960A/P</b>	1	0,129	7,68	65x41x88
7004A	REGULAR - blue plastic down-press wringer with plastic gears			1 pc.
7963A	Plastic grip for Orion and Fred trolleys			1 pc.
8108A	Blue plastic bucket 15 L with plastic handle			1 pc.
8108B	Red plastic bucket 15 L with plastic handle			1 pc.
8331SS	Plastic frame with wheels ø 80 mm for Fred trolley 30 L			1 pc.



## FRED - plastic trolley 50 L with plastic grip



REF.	PCK	VOLUME (m³)	GROSS WEIGHT (kg)	SIZE (cm) ↓ ↓ ↓
<b>7965A/P</b>	1	0,177	8,93	69x42x93
7004A	REGULAR - blue plastic down-press wringer with plastic gears			1 pc.
7963A	Plastic grip for Orion and Fred trolleys			1 pc.
8107A	Blue plastic bucket 25 L with plastic handle			1 pc.
8107B	Red plastic bucket 25 L with plastic handle			1 pc.
8332SS	Plastic frame with wheels ø 80 mm for Fred 50 L and Arka trolleys			1 pc.



## FRED - plastic trolley 30 L with plastic grip and basket



REF.	PCK	VOLUME (m³)	GROSS WEIGHT (kg)	SIZE (cm) ↓ ↓ ↓
<b>03007960A/P</b>	1	0,129	7,95	65x50x88
60402A	Plastic carry basket			1 pc.
7004A	REGULAR - blue plastic down-press wringer with plastic gears			1 pc.
7963A	Plastic grip for Orion and Fred trolleys			1 pc.
8108A	Blue plastic bucket 15 L with plastic handle			1 pc.
8108B	Red plastic bucket 15 L with plastic handle			1 pc.
8331SS	Plastic frame with wheels ø 80 mm for Fred trolley 30 L			1 pc.



## FRED - plastic trolley 50 L with plastic grip and basket



REF.	PCK	VOLUME (m³)	GROSS WEIGHT (kg)	SIZE (cm) ↓ ↓ ↓
<b>03007965A/P</b>	1	0,177	9,2	69x51x93
60402A	Plastic carry basket			1 pc.
7004A	REGULAR - blue plastic down-press wringer with plastic gears			1 pc.
7963A	Plastic grip for Orion and Fred trolleys			1 pc.
8107A	Blue plastic bucket 25 L with plastic handle			1 pc.
8107B	Red plastic bucket 25 L with plastic handle			1 pc.
8332SS	Plastic frame with wheels ø 80 mm for Fred 50 L and Arka trolleys			1 pc.





PLASTIC MOP TROLLEYS

CHROMED AND RILSAN COATED TROLLEYS

BUCKET/WRINGER COMBOS

WRINGERS

MULTI-PURPOSE BUCKETS

TOP-DOWN® BUCKETS

OTHER PLASTIC BUCKETS

## FRED - plastic trolley 30 L with plastic grip and bag holder



REF.	PCK	VOLUME (m <sup>3</sup> )	GROSS WEIGHT (kg)	SIZE (cm) ↓ ↓ ↓
<b>04007960A/P</b>	1	0,129	7,91	65x50x88
7004A	REGULAR - blue plastic down-press wringer with plastic gears			1 pc.
7963A	Plastic grip for Orion and Fred trolleys			1 pc.
8108A	Blue plastic bucket 15 L with plastic handle			1 pc.
8108B	Red plastic bucket 15 L with plastic handle			1 pc.
8331SS	Plastic frame with wheels ø 80 mm for Fred trolley 30 L			1 pc.
P206003A	Plastic bag holder for Orion-Fred-Vega trolleys fitting push-bar art. 7963A and supports art. P290800A - P179002A			1 pc.



## FRED - plastic trolley 30 L with plastic grip and bag holder



REF.	PCK	VOLUME (m <sup>3</sup> )	GROSS WEIGHT (kg)	SIZE (cm) ↓ ↓ ↓
<b>04007965A/P</b>	1	0,177	9,15	69x51x93
7004A	REGULAR - blue plastic down-press wringer with plastic gears			1 pc.
7963A	Plastic grip for Orion and Fred trolleys			1 pc.
8107A	Blue plastic bucket 25 L with plastic handle			1 pc.
8107B	Red plastic bucket 25 L with plastic handle			1 pc.
8332SS	Plastic frame with wheels ø 80 mm for Fred 50 L and Arka trolleys			1 pc.
P206003A	Plastic bag holder for Orion-Fred-Vega trolleys fitting push-bar art. 7963A and supports art. P290800A - P179002A			1 pc.



## Orion trolleys

### ORION - plastic trolley 15 L



REF.	PCK	VOLUME (m <sup>3</sup> )	GROSS WEIGHT (kg)	SIZE (cm) ↓ ↓ ↓
<b>7961A</b>	1	0,138	7,04	53x42x90
60295A	Bucket reduction for Orion trolley 15 L			1 pc.
7004A	REGULAR - blue plastic down-press wringer with plastic gears			1 pc.
8108B	Red plastic bucket 15 L with plastic handle			1 pc.
8335SS	Plastic frame with wheels ø 80 mm for Orion and Vega trolleys			1 pc.



### ORION - plastic trolley 25 L



REF.	PCK	VOLUME (m <sup>3</sup> )	GROSS WEIGHT (kg)	SIZE (cm) ↓ ↓ ↓
<b>7962A</b>	1	0,138	7,09	53x42x90
7004A	REGULAR - blue plastic down-press wringer with plastic gears			1 pc.
8107B	Red plastic bucket 25 L with plastic handle			1 pc.
8335SS	Plastic frame with wheels ø 80 mm for Orion and Vega trolleys			1 pc.



# Buckets and wringer trolleys



PLASTIC MOP TROLLEYS

CHROMED AND RILSAN COATED TROLLEYS

BUCKET/WRINGER COMBOS

WRINGERS

MULTI-PURPOSE BUCKETS

TOP-DOWN® BUCKETS

OTHER PLASTIC BUCKETS

## ORION - plastic trolley 15 L



REF.	PCK	VOLUME (m³)	GROSS WEIGHT (kg)	SIZE (cm) ↓ ↓ ↓
<b>7961A/P</b>	1	0,138	7,36	53x42x93
60295A	Bucket reduction for Orion trolley 15 L			1 pc.
7004A	REGULAR - blue plastic down-press wringer with plastic gears			1 pc.
7963A	Plastic grip for Orion and Fred trolleys			1 pc.
8108B	Red plastic bucket 15 L with plastic handle			1 pc.
8335SS	Plastic frame with wheels ø 80 mm for Orion and Vega trolleys			1 pc.



## ORION - plastic trolley 25 L



REF.	PCK	VOLUME (m³)	GROSS WEIGHT (kg)	SIZE (cm) ↓ ↓ ↓
<b>7962A/P</b>	1	0,138	7,42	53x42x93
7004A	REGULAR - blue plastic down-press wringer with plastic gears			1 pc.
7963A	Plastic grip for Orion and Fred trolleys			1 pc.
8107B	Red plastic bucket 25 L with plastic handle			1 pc.
8335SS	Plastic frame with wheels ø 80 mm for Orion and Vega trolleys			1 pc.



## ORION - plastic trolley 15 L



REF.	PCK	VOLUME (m³)	GROSS WEIGHT (kg)	SIZE (cm) ↓ ↓ ↓
<b>7961A/I</b>	1	0,138	7,63	62x42x90
60295A	Bucket reduction for Orion trolley 15 L			1 pc.
7004A	REGULAR - blue plastic down-press wringer with plastic gears			1 pc.
7966A	Reinforced push-bar for Orion and Vega trolleys			1 pc.
8108B	Red plastic bucket 15 L with plastic handle			1 pc.
8335SS	Plastic frame with wheels ø 80 mm for Orion and Vega trolleys			1 pc.



## ORION - plastic trolley 25 L



REF.	PCK	VOLUME (m³)	GROSS WEIGHT (kg)	SIZE (cm) ↓ ↓ ↓
<b>7962A/I</b>	1	0,138	7,68	62x42x90
7004A	REGULAR - blue plastic down-press wringer with plastic gears			1 pc.
7966A	Reinforced push-bar for Orion and Vega trolleys			1 pc.
8107B	Red plastic bucket 25 L with plastic handle			1 pc.
8335SS	Plastic frame with wheels ø 80 mm for Orion and Vega trolleys			1 pc.



PLASTIC MOP TROLLEYS

CHROMED AND RILSAN COATED TROLLEYS

BUCKET/WRINGER COMBOS

WRINGERS

MULTI-PURPOSE BUCKETS

TOP-DOWN® BUCKETS

OTHER PLASTIC BUCKETS

## Vega trolleys

### VEGA LP0302 - plastic trolley 28 L



REF.	PCK	VOLUME (m³)	GROSS WEIGHT (kg)	SIZE (cm) ↓ ↓ ↓
<b>0000LP0302A</b>	1	0,172	8,58	71x42x90
0000SE1128B	Red plastic bucket 28 L with 2 plastic handles and removable divider			1 pc.
0000SM00102U	Hook fitting plastic push-bar art. 7964A - 7966A			1 pc.
7002A	DEEP - plastic side press wringer without bottom			1 pc.
7966A	Reinforced push-bar for Orion and Vega trolleys			1 pc.
8335SS	Plastic frame with wheels ø 80 mm for Orion and Vega trolleys			1 pc.



### VEGA LP0304 - plastic trolley 28 L



REF.	PCK	VOLUME (m³)	GROSS WEIGHT (kg)	SIZE (cm) ↓ ↓ ↓
<b>0000LP0304A</b>	1	0,172	8,91	80x42x90
0000SE1128B	Red plastic bucket 28 L with 2 plastic handles and removable divider			1 pc.
0000SM00102U	Hook fitting plastic push-bar art. 7964A - 7966A			1 pc.
7002A	DEEP - plastic side press wringer without bottom			1 pc.
7966A	Reinforced push-bar for Orion and Vega trolleys			1 pc.
8335SS	Plastic frame with wheels ø 80 mm for Orion and Vega trolleys			1 pc.
P206002A	Bagholder 50 L for Vega trolley fitting plastic push-bar art. 7966A			1 pc.



### VEGA LP0308 - plastic trolley 25 L



REF.	PCK	VOLUME (m³)	GROSS WEIGHT (kg)	SIZE (cm) ↓ ↓ ↓
<b>0000LP0308A</b>	1	0,131	8,05	71x42x90
0000SM00102U	Hook fitting plastic push-bar art. 7964A - 7966A			1 pc.
7004A	REGULAR - blue plastic down-press wringer with plastic gears			1 pc.
7966A	Reinforced push-bar for Orion and Vega trolleys			1 pc.
8107B	Red plastic bucket 25 L with plastic handle			1 pc.
8335SS	Plastic frame with wheels ø 80 mm for Orion and Vega trolleys			1 pc.
P206002A	Bagholder 50 L for Vega trolley fitting plastic push-bar art. 7966A			1 pc.



### VEGA LP0305 - plastic trolley 28 L



REF.	PCK	VOLUME (m³)	GROSS WEIGHT (kg)	SIZE (cm) ↓ ↓ ↓
<b>0000LP0305A</b>	1	0,172	9,9	71x42x112
0000SE0104A	Blue plastic bucket 4 L with plastic handle			1 pc.
0000SE0104B	Red plastic bucket 4 L with plastic handle			1 pc.
0000SE1128B	Red plastic bucket 28 L with 2 plastic handles and removable divider			1 pc.
0000SM00102U	Hook fitting plastic push-bar art. 7964A - 7966A			1 pc.
0000SM00110U	FLIP - handle holder with rubber roll fitting plastic basket art. 60402A and plastic bucket holder art. P220001E			1 pc.
0000SM00215U	Hook fitting plastic basket art. 60402A and plastic bucket support art. P220001E			1 pc.
7002A	DEEP - plastic side press wringer without bottom			1 pc.
7966A	Reinforced push-bar for Orion and Vega trolleys			1 pc.
8335SS	Plastic frame with wheels ø 80 mm for Orion and Vega trolleys			1 pc.
P120004E	Big support for plastic bucket holder art. P220001E			1 pc.
P220001E	Plastic bucket holder complete with supports (small and medium) for Vega and Arka trolleys			1 pc.



BUCKETS AND WRINGER TROLLEYS

# Buckets and wringer trolleys



PLASTIC MOP TROLLEYS

CHROMED AND RILSAN COATED TROLLEYS

BUCKET/WRINGER COMBOS

WRINGERS

MULTI-PURPOSE BUCKETS

TOP-DOWN® BUCKETS

OTHER PLASTIC BUCKETS

## VEGA LP0309 - plastic trolley 25 L



REF.	PCK	VOLUME (m³)	GROSS WEIGHT (kg)	SIZE (cm)
<b>0000LP0309A</b>	1	0,172	9,15	62x42x112
0000SE0104A	Blue plastic bucket 4 L with plastic handle			1 pc.
0000SE0104B	Red plastic bucket 4 L with plastic handle			1 pc.
0000SM00102U	Hook fitting plastic push-bar art. 7964A - 7966A			1 pc.
0000SM00110U	FLIP - handle holder with rubber roll fitting plastic basket art. 60402A and plastic bucket holder art. P220001E			1 pc.
0000SM00215U	Hook fitting plastic basket art. 60402A and plastic bucket support art. P220001E			1 pc.
7004A	REGULAR - blue plastic down-press wringer with plastic gears			1 pc.
7966A	Reinforced push-bar for Orion and Vega trolleys			1 pc.
8107B	Red plastic bucket 25 L with plastic handle			1 pc.
8335SS	Plastic frame with wheels ø 80 mm for Orion and Vega trolleys			1 pc.
P120004E	Big support for plastic bucket holder art. P220001E			1 pc.
P220001E	Plastic bucket holder complete with supports (small and medium) for Vega and Arka trolleys			1 pc.



## VEGA LP0307 - plastic trolley 25 L



REF.	PCK	VOLUME (m³)	GROSS WEIGHT (kg)	SIZE (cm)
<b>0000LP0307A</b>	1	0,172	9,48	71x42x112
0000SE0104A	Blue plastic bucket 4 L with plastic handle			1 pc.
0000SE0104B	Red plastic bucket 4 L with plastic handle			1 pc.
0000SM00102U	Hook fitting plastic push-bar art. 7964A - 7966A			1 pc.
0000SM00110U	FLIP - handle holder with rubber roll fitting plastic basket art. 60402A and plastic bucket holder art. P220001E			1 pc.
0000SM00215U	Hook fitting plastic basket art. 60402A and plastic bucket support art. P220001E			1 pc.
7004A	REGULAR - blue plastic down-press wringer with plastic gears			1 pc.
7966A	Reinforced push-bar for Orion and Vega trolleys			1 pc.
8107B	Red plastic bucket 25 L with plastic handle			1 pc.
8335SS	Plastic frame with wheels ø 80 mm for Orion and Vega trolleys			1 pc.
P206002A	Bagholder 50 L for Vega trolley fitting plastic push-bar art. 7966A			1 pc.
P220001E	Plastic bucket holder complete with supports (small and medium) for Vega and Arka trolleys			1 pc.



## VEGA 22LP0303 - plastic trolley 28 L



REF.	PCK	VOLUME (m³)	GROSS WEIGHT (kg)	SIZE (cm)
<b>0022LP0303A</b>	1	0,172	11,03	80x42x112
0000SE0104A	Blue plastic bucket 4 L with plastic handle			1 pc.
0000SE0104B	Red plastic bucket 4 L with plastic handle			1 pc.
0000SE1128B	Red plastic bucket 28 L with 2 plastic handles and removable divider			1 pc.
0000SM00102U	Hook fitting plastic push-bar art. 7964A - 7966A			1 pc.
0000SM00110U	FLIP - handle holder with rubber roll fitting plastic basket art. 60402A and plastic bucket holder art. P220001E			1 pc.
0000SM00215U	Hook fitting plastic basket art. 60402A and plastic bucket support art. P220001E			1 pc.
14000A	PUNTO - roll plastic wringer, central position			1 pc.
7966A	Reinforced push-bar for Orion and Vega trolleys			1 pc.
8335SS	Plastic frame with wheels ø 80 mm for Orion and Vega trolleys			1 pc.
P206002A	Bagholder 50 L for Vega trolley fitting plastic push-bar art. 7966A			1 pc.
P220001E	Plastic bucket holder complete with supports (small and medium) for Vega and Arka trolleys			1 pc.



## VEGA LP0303 - plastic trolley 28 L



REF.	PCK	VOLUME (m³)	GROSS WEIGHT (kg)	SIZE (cm)
<b>0000LP0303A</b>	1	0,172	9,7	80x42x112
0000SE0104A	Blue plastic bucket 4 L with plastic handle			1 pc.
0000SE0104B	Red plastic bucket 4 L with plastic handle			1 pc.
0000SE1128B	Red plastic bucket 28 L with 2 plastic handles and removable divider			1 pc.
0000SM00102U	Hook fitting plastic push-bar art. 7964A - 7966A			1 pc.
0000SM00110U	FLIP - handle holder with rubber roll fitting plastic basket art. 60402A and plastic bucket holder art. P220001E			1 pc.
0000SM00215U	Hook fitting plastic basket art. 60402A and plastic bucket support art. P220001E			1 pc.
7002A	DEEP - plastic side press wringer without bottom			1 pc.
7966A	Reinforced push-bar for Orion and Vega trolleys			1 pc.
8335SS	Plastic frame with wheels ø 80 mm for Orion and Vega trolleys			1 pc.
P206002A	Bagholder 50 L for Vega trolley fitting plastic push-bar art. 7966A			1 pc.
P220001E	Plastic bucket holder complete with supports (small and medium) for Vega and Arka trolleys			1 pc.



## Arka trolleys

### ARKA 10 - plastic trolley 28 L



REF.	PCK	VOLUME (m³)	GROSS WEIGHT (kg)	SIZE (cm) ↓ ↓ ↓
<b>0006LP1280A</b>	1	0,211	11,73	107x55x92
0000SE1128B	Red plastic bucket 28 L with 2 plastic handles and removable divider			1 pc.
7002A	DEEP - plastic side press wringer without bottom			1 pc.
7964A	Reinforced plastic push-bar for Arka trolley			1 pc.
8332SS	Plastic frame with wheels ø 80 mm for Fred 50 L and Arka trolleys			1 pc.
P114011A	Supporting plastic plate for Arka trolley			1 pc.
P281001E	Set of two grey pushing grips (right and left) with reinforcements (right and left) and fixing screws for Arka trolley			1 pc.
P306010A	Plastic bagholder 100 L with bag-stretchers and cover with chek-list holder for Arka trolley			1 pc.

**ON REQUEST, WITH SURCHARGE**

with 2 wheels 80 mm + 2 axial wheels 200 mm

**TROLLEY REF.  
0006LP2280A**

### ARKA 11 - plastic trolley 28 L



REF.	PCK	VOLUME (m³)	GROSS WEIGHT (kg)	SIZE (cm) ↓ ↓ ↓
<b>0006LP1281A</b>	1	0,211	13	107x55x111
0000SE0104A	Blue plastic bucket 4 L with plastic handle			1 pc.
0000SE0104B	Red plastic bucket 4 L with plastic handle			1 pc.
0000SE1128B	Red plastic bucket 28 L with 2 plastic handles and removable divider			1 pc.
0000SM00110U	FLIP - handle holder with rubber roll fitting plastic basket art. 60402A and plastic bucket holder art. P220001E			1 pc.
0000SM00215U	Hook fitting plastic basket art. 60402A and plastic bucket support art. P220001E			1 pc.
7002A	DEEP - plastic side press wringer without bottom			1 pc.
7964A	Reinforced plastic push-bar for Arka trolley			1 pc.
8332SS	Plastic frame with wheels ø 80 mm for Fred 50 L and Arka trolleys			1 pc.
P114011A	Supporting plastic plate for Arka trolley			1 pc.
P120004E	Big support for plastic bucket holder art. P220001E			1 pc.
P220001E	Plastic bucket holder complete with supports (small and medium) for Vega and Arka trolleys			1 pc.
P281001E	Set of two grey pushing grips (right and left) with reinforcements (right and left) and fixing screws for Arka trolley			1 pc.
P306010A	Plastic bagholder 100 L with bag-stretchers and cover with chek-list holder for Arka trolley			1 pc.

**ON REQUEST, WITH SURCHARGE**

with 2 wheels 80 mm + 2 axial wheels 200 mm

**TROLLEY REF.  
0006LP2281A**

### ARKA 12 - plastic trolley 28 L



REF.	PCK	VOLUME (m³)	GROSS WEIGHT (kg)	SIZE (cm) ↓ ↓ ↓
<b>0006LP1282A</b>	1	0,211	13,55	107x60x111
0000SE0104A	Blue plastic bucket 4 L with plastic handle			1 pc.
0000SE0104B	Red plastic bucket 4 L with plastic handle			1 pc.
0000SE1128B	Red plastic bucket 28 L with 2 plastic handles and removable divider			1 pc.
0000SM00110U	FLIP - handle holder with rubber roll fitting plastic basket art. 60402A and plastic bucket holder art. P220001E			1 pc.
0000SM00215U	Hook fitting plastic basket art. 60402A and plastic bucket support art. P220001E			1 pc.
7002A	DEEP - plastic side press wringer without bottom			1 pc.
7964A	Reinforced plastic push-bar for Arka trolley			1 pc.
8332SS	Plastic frame with wheels ø 80 mm for Fred 50 L and Arka trolleys			1 pc.
P114011A	Supporting plastic plate for Arka trolley			1 pc.
P120004E	Big support for plastic bucket holder art. P220001E			1 pc.
P220001E	Plastic bucket holder complete with supports (small and medium) for Vega and Arka trolleys			1 pc.
P224002E	Plastic basket or bucket holder complete with supports for Vega and Arka trolleys			1 pc.
P281001E	Set of two grey pushing grips (right and left) with reinforcements (right and left) and fixing screws for Arka trolley			1 pc.
P306010A	Plastic bagholder 100 L with bag-stretchers and cover with chek-list holder for Arka trolley			1 pc.

**ON REQUEST, WITH SURCHARGE**

with 2 wheels 80 mm + 2 axial wheels 200 mm

**TROLLEY REF.  
0006LP2282A**



# Buckets and wringer trolleys



PLASTIC MOP TROLLEYS

CHROMED AND RILSAN COATED TROLLEYS

BUCKET/WRINGER COMBOS

WRINGERS

MULTI-PURPOSE BUCKETS

TOP-DOWN® BUCKETS

OTHER PLASTIC BUCKETS

## ARKA 13 - plastic trolley 28 L



REF.	PCK	VOLUME (m³)	GROSS WEIGHT (kg)	SIZE (cm)
<b>0006LP1283A</b>	1	0,211	13,97	107x65x111
0000SE0104A	Blue plastic bucket 4 L with plastic handle			1 pc.
0000SE0104B	Red plastic bucket 4 L with plastic handle			1 pc.
0000SE1128B	Red plastic bucket 28 L with 2 plastic handles and removable divider			1 pc.
0000SM00110U	FLIP - handle holder with rubber roll fitting plastic basket art. 60402A and plastic bucket holder art. P220001E			1 pc.
0000SM00215U	Hook fitting plastic basket art. 60402A and plastic bucket support art. P220001E			1 pc.
7002A	DEEP - plastic side press wringer without bottom			1 pc.
7964A	Reinforced plastic push-bar for Arka trolley			1 pc.
8332SS	Plastic frame with wheels ø 80 mm for Fred 50 L and Arka trolleys			1 pc.
P114011A	Supporting plastic plate for Arka trolley			1 pc.
P120004E	Big support for plastic bucket holder art. P220001E			1 pc.
P220001E	Plastic bucket holder complete with supports (small and medium) for Vega and Arka trolleys			1 pc.
P224002E	Plastic basket or bucket holder complete with supports for Vega and Arka trolleys			1 pc.
P225004A	Set of plastic paper holder with cover complete with 3 hooks			1 pc.
P281001E	Set of two grey pushing grips (right and left) with reinforcements (right and left) and fixing screws for Arka trolley			1 pc.
P306010A	Plastic bagholder 100 L with bag-stretchers and cover with chek-list holder for Arka trolley			1 pc.



### ON REQUEST, WITH SURCHARGE



with 2 wheels 80 mm + 2 axial wheels 200 mm

TROLLEY REF.  
**0006LP2283A**

## ARKA 14 - plastic trolley 28 L



REF.	PCK	VOLUME (m³)	GROSS WEIGHT (kg)	SIZE (cm)
<b>0006LP1284A</b>	1	0,211	14,59	107x65x111
0000SE0104A	Blue plastic bucket 4 L with plastic handle			1 pc.
0000SE0104B	Red plastic bucket 4 L with plastic handle			1 pc.
0000SE1128B	Red plastic bucket 28 L with 2 plastic handles and removable divider			1 pc.
0000SM00110U	FLIP - handle holder with rubber roll fitting plastic basket art. 60402A and plastic bucket holder art. P220001E			1 pc.
0000SM00215U	Hook fitting plastic basket art. 60402A and plastic bucket support art. P220001E			1 pc.
7002A	DEEP - plastic side press wringer without bottom			1 pc.
7964A	Reinforced plastic push-bar for Arka trolley			1 pc.
8332SS	Plastic frame with wheels ø 80 mm for Fred 50 L and Arka trolleys			1 pc.
P114011A	Supporting plastic plate for Arka trolley			1 pc.
P120004E	Big support for plastic bucket holder art. P220001E			1 pc.
P120007A	Plastic quiver for polybags			1 pc.
P220001E	Plastic bucket holder complete with supports (small and medium) for Vega and Arka trolleys			1 pc.
P224002E	Plastic basket or bucket holder complete with supports for Vega and Arka trolleys			1 pc.
P225004A	Set of plastic paper holder with cover complete with 3 hooks			1 pc.
P281001E	Set of two grey pushing grips (right and left) with reinforcements (right and left) and fixing screws for Arka trolley			1 pc.
P306010A	Plastic bagholder 100 L with bag-stretchers and cover with chek-list holder for Arka trolley			1 pc.



### ON REQUEST, WITH SURCHARGE



with 2 wheels 80 mm + 2 axial wheels 200 mm

TROLLEY REF.  
**0006LP2284A**

PLASTIC MOP TROLLEYS

CHROMED AND RILSAN COATED TROLLEYS

BUCKET/WRINGER COMBOS

WRINGERS

MULTI-PURPOSE BUCKETS

TOP-DOWN® BUCKETS

OTHER PLASTIC BUCKETS

## ARKA 15 - plastic trolley 28 L

REF.	PCK	VOLUME (m <sup>3</sup> )	GROSS WEIGHT (kg)	SIZE (cm)
<b>0006LP1285A</b>	1	0,211	14,82	107x65x111
0000SE0104A	Blue plastic bucket 4 L with plastic handle			1 pc.
0000SE0104B	Red plastic bucket 4 L with plastic handle			1 pc.
0000SE1128B	Red plastic bucket 28 L with 2 plastic handles and removable divider			1 pc.
0000SM00110U	FLIP - handle holder with rubber roll fitting plastic basket art. 60402A and plastic bucket holder art. P220001E			1 pc.
0000SM00215U	Hook fitting plastic basket art. 60402A and plastic bucket support art. P220001E			1 pc.
7002A	DEEP - plastic side press wringer without bottom			1 pc.
7964A	Reinforced plastic push-bar for Arka trolley			1 pc.
8332SS	Plastic frame with wheels ø 80 mm for Fred 50 L and Arka trolleys			1 pc.
P114011A	Supporting plastic plate for Arka trolley			1 pc.
P120004E	Big support for plastic bucket holder art. P220001E			1 pc.
P120007A	Plastic quiver for polybags			1 pc.
P120008A	Plastic quiver for window squeegees, washers, scrapers			1 pc.
P220001E	Plastic bucket holder complete with supports (small and medium) for Vega and Arka trolleys			1 pc.
P224002E	Plastic basket or bucket holder complete with supports for Vega and Arka trolleys			1 pc.
P225004A	Set of plastic paper holder with cover complete with 3 hooks			1 pc.
P281001E	Set of two grey pushing grips (right and left) with reinforcements (right and left) and fixing screws for Arka trolley			1 pc.
P306010A	Plastic bagholder 100 L with bag-stretchers and cover with chek-list holder for Arka trolley			1 pc.



### ON REQUEST, WITH SURCHARGE



with 2 wheels 80 mm + 2 axial wheels 200 mm

TROLLEY REF.  
**0006LP2285A**

## ARKA 20 - plastic trolley 28 L

REF.	PCK	VOLUME (m <sup>3</sup> )	GROSS WEIGHT (kg)	SIZE (cm)
<b>0022LP1280A</b>	1	0,211	12,53	107x55x92
0000SE1128B	Red plastic bucket 28 L with 2 plastic handles and removable divider			1 pc.
14000A	PUNTO - roll plastic wringer, central position			1 pc.
7964A	Reinforced plastic push-bar for Arka trolley			1 pc.
8332SS	Plastic frame with wheels ø 80 mm for Fred 50 L and Arka trolleys			1 pc.
P114011A	Supporting plastic plate for Arka trolley			1 pc.
P281001E	Set of two grey pushing grips (right and left) with reinforcements (right and left) and fixing screws for Arka trolley			1 pc.
P306010A	Plastic bagholder 100 L with bag-stretchers and cover with chek-list holder for Arka trolley			1 pc.



### ON REQUEST, WITH SURCHARGE



with 2 wheels 80 mm + 2 axial wheels 200 mm

TROLLEY REF.  
**0022LP2280A**

## ARKA 21 - plastic trolley 28 L

REF.	PCK	VOLUME (m <sup>3</sup> )	GROSS WEIGHT (kg)	SIZE (cm)
<b>0022LP1281A</b>	1	0,211	13,8	107x56x111
0000SE0104A	Blue plastic bucket 4 L with plastic handle			1 pc.
0000SE0104B	Red plastic bucket 4 L with plastic handle			1 pc.
0000SE1128B	Red plastic bucket 28 L with 2 plastic handles and removable divider			1 pc.
0000SM00110U	FLIP - handle holder with rubber roll fitting plastic basket art. 60402A and plastic bucket holder art. P220001E			1 pc.
0000SM00215U	Hook fitting plastic basket art. 60402A and plastic bucket support art. P220001E			1 pc.
14000A	PUNTO - roll plastic wringer, central position			1 pc.
7964A	Reinforced plastic push-bar for Arka trolley			1 pc.
8332SS	Plastic frame with wheels ø 80 mm for Fred 50 L and Arka trolleys			1 pc.
P114011A	Supporting plastic plate for Arka trolley			1 pc.
P120004E	Big support for plastic bucket holder art. P220001E			1 pc.
P220001E	Plastic bucket holder complete with supports (small and medium) for Vega and Arka trolleys			1 pc.
P281001E	Set of two grey pushing grips (right and left) with reinforcements (right and left) and fixing screws for Arka trolley			1 pc.
P306010A	Plastic bagholder 100 L with bag-stretchers and cover with chek-list holder for Arka trolley			1 pc.



### ON REQUEST, WITH SURCHARGE



with 2 wheels 80 mm + 2 axial wheels 200 mm

TROLLEY REF.  
**0022LP2281A**

# Buckets and wringer trolleys



PLASTIC MOP TROLLEYS

CHROMED AND RILSAN COATED TROLLEYS

BUCKET/WRINGER COMBOS

WRINGERS

MULTI-PURPOSE BUCKETS

TOP-DOWN® BUCKETS

OTHER PLASTIC BUCKETS

## ARKA 22 - plastic trolley 28 L



REF.	PCK	VOLUME (m³)	GROSS WEIGHT (kg)	SIZE (cm) ↓ ↓ ↓
<b>0022LP1282A</b>	1	0,211	14,35	107x60x111
0000SE0104A	Blue plastic bucket 4 L with plastic handle			1 pc.
0000SE0104B	Red plastic bucket 4 L with plastic handle			1 pc.
0000SE1128B	Red plastic bucket 28 L with 2 plastic handles and removable divider			1 pc.
0000SM00110U	FLIP - handle holder with rubber roll fitting plastic basket art. 60402A and plastic bucket holder art. P220001E			1 pc.
0000SM00215U	Hook fitting plastic basket art. 60402A and plastic bucket support art. P220001E			1 pc.
14000A	PUNTO - roll plastic wringer, central position			1 pc.
7964A	Reinforced plastic push-bar for Arka trolley			1 pc.
8332SS	Plastic frame with wheels ø 80 mm for Fred 50 L and Arka trolleys			1 pc.
P114011A	Supporting plastic plate for Arka trolley			1 pc.
P120004E	Big support for plastic bucket holder art. P220001E			1 pc.
P220001E	Plastic bucket holder complete with supports (small and medium) for Vega and Arka trolleys			1 pc.
P224002E	Plastic basket or bucket holder complete with supports for Vega and Arka trolleys			1 pc.
P281001E	Set of two grey pushing grips (right and left) with reinforcements (right and left) and fixing screws for Arka trolley			1 pc.
P306010A	Plastic bagholder 100 L with bag-stretchers and cover with chek-list holder for Arka trolley			1 pc.



### ON REQUEST, WITH SURCHARGE



with 2 wheels 80 mm + 2 axial wheels 200 mm

TROLLEY REF.  
**0022LP2282A**

## ARKA 23 - plastic trolley 28 L



REF.	PCK	VOLUME (m³)	GROSS WEIGHT (kg)	SIZE (cm) ↓ ↓ ↓
<b>0022LP1283A</b>	1	0,211	14,77	107x65x111
0000SE0104A	Blue plastic bucket 4 L with plastic handle			1 pc.
0000SE0104B	Red plastic bucket 4 L with plastic handle			1 pc.
0000SE1128B	Red plastic bucket 28 L with 2 plastic handles and removable divider			1 pc.
0000SM00110U	FLIP - handle holder with rubber roll fitting plastic basket art. 60402A and plastic bucket holder art. P220001E			1 pc.
0000SM00215U	Hook fitting plastic basket art. 60402A and plastic bucket support art. P220001E			1 pc.
14000A	PUNTO - roll plastic wringer, central position			1 pc.
7964A	Reinforced plastic push-bar for Arka trolley			1 pc.
8332SS	Plastic frame with wheels ø 80 mm for Fred 50 L and Arka trolleys			1 pc.
P114011A	Supporting plastic plate for Arka trolley			1 pc.
P120004E	Big support for plastic bucket holder art. P220001E			1 pc.
P220001E	Plastic bucket holder complete with supports (small and medium) for Vega and Arka trolleys			1 pc.
P224002E	Plastic basket or bucket holder complete with supports for Vega and Arka trolleys			1 pc.
P225004A	Set of plastic paper holder with cover complete with 3 hooks			1 pc.
P281001E	Set of two grey pushing grips (right and left) with reinforcements (right and left) and fixing screws for Arka trolley			1 pc.
P306010A	Plastic bagholder 100 L with bag-stretchers and cover with chek-list holder for Arka trolley			1 pc.



### ON REQUEST, WITH SURCHARGE



with 2 wheels 80 mm + 2 axial wheels 200 mm

TROLLEY REF.  
**0022LP2283A**

PLASTIC MOP TROLLEYS

CHROMED AND RILSAN COATED TROLLEYS

BUCKET/WRINGER COMBOS

WRINGERS

MULTI-PURPOSE BUCKETS

TOP-DOWN® BUCKETS

OTHER PLASTIC BUCKETS

## ARKA 24 - plastic trolley 28 L



REF.	PCK	VOLUME (m³)	GROSS WEIGHT (kg)	SIZE (cm)
<b>0022LP1284A</b>	1	0,211	14,73	107x65x111
0000SE0104A	Blue plastic bucket 4 L with plastic handle			1 pc.
0000SE0104B	Red plastic bucket 4 L with plastic handle			1 pc.
0000SE1128B	Red plastic bucket 28 L with 2 plastic handles and removable divider			1 pc.
0000SM00110U	FLIP - handle holder with rubber roll fitting plastic basket art. 60402A and plastic bucket holder art. P220001E			1 pc.
0000SM00215U	Hook fitting plastic basket art. 60402A and plastic bucket support art. P220001E			1 pc.
14000A	PUNTO - roll plastic wringer, central position			1 pc.
7964A	Reinforced plastic push-bar for Arka trolley			1 pc.
8332SS	Plastic frame with wheels ø 80 mm for Fred 50 L and Arka trolleys			1 pc.
P114011A	Supporting plastic plate for Arka trolley			1 pc.
P120004E	Big support for plastic bucket holder art. P220001E			1 pc.
P120007A	Plastic quiver for polybags			1 pc.
P220001E	Plastic bucket holder complete with supports (small and medium) for Vega and Arka trolleys			1 pc.
P224002E	Plastic basket or bucket holder complete with supports for Vega and Arka trolleys			1 pc.
P225004A	Set of plastic paper holder with cover complete with 3 hooks			1 pc.
P281001E	Set of two grey pushing grips (right and left) with reinforcements (right and left) and fixing screws for Arka trolley			1 pc.
P306010A	Plastic bagholder 100 L with bag-stretchers and cover with chek-list holder for Arka trolley			1 pc.



### ON REQUEST, WITH SURCHARGE



with 2 wheels 80 mm + 2 axial wheels 200 mm

TROLLEY REF.  
**0022LP2284A**

## ARKA 25 - plastic trolley 28 L



REF.	PCK	VOLUME (m³)	GROSS WEIGHT (kg)	SIZE (cm)
<b>0022LP1285A</b>	1	0,211	14,96	107x65x111
0000SE0104A	Blue plastic bucket 4 L with plastic handle			1 pc.
0000SE0104B	Red plastic bucket 4 L with plastic handle			1 pc.
0000SE1128B	Red plastic bucket 28 L with 2 plastic handles and removable divider			1 pc.
0000SM00110U	FLIP - handle holder with rubber roll fitting plastic basket art. 60402A and plastic bucket holder art. P220001E			1 pc.
0000SM00215U	Hook fitting plastic basket art. 60402A and plastic bucket support art. P220001E			1 pc.
14000A	PUNTO - roll plastic wringer, central position			1 pc.
7964A	Reinforced plastic push-bar for Arka trolley			1 pc.
8332SS	Plastic frame with wheels ø 80 mm for Fred 50 L and Arka trolleys			1 pc.
P114011A	Supporting plastic plate for Arka trolley			1 pc.
P120004E	Big support for plastic bucket holder art. P220001E			1 pc.
P120007A	Plastic quiver for polybags			1 pc.
P120008A	Plastic quiver for window squeegees, washers, scrapers			1 pc.
P220001E	Plastic bucket holder complete with supports (small and medium) for Vega and Arka trolleys			1 pc.
P224002E	Plastic basket or bucket holder complete with supports for Vega and Arka trolleys			1 pc.
P225004A	Set of plastic paper holder with cover complete with 3 hooks			1 pc.
P281001E	Set of two grey pushing grips (right and left) with reinforcements (right and left) and fixing screws for Arka trolley			1 pc.
P306010A	Plastic bagholder 100 L with bag-stretchers and cover with chek-list holder for Arka trolley			1 pc.



### ON REQUEST, WITH SURCHARGE



with 2 wheels 80 mm + 2 axial wheels 200 mm

TROLLEY REF.  
**0022LP2285A**

# Buckets and wringer trolleys



PLASTIC MOP TROLLEYS

CHROMED AND RILSAN COATED TROLLEYS

BUCKET/WRINGER COMBOS

WRINGERS

MULTI-PURPOSE BUCKETS

TOP-DOWN® BUCKETS

OTHER PLASTIC BUCKETS

## ARKA 30 - plastic trolley 28 L



REF.	PCK	VOLUME (m³)	GROSS WEIGHT (kg)	SIZE (cm)
<b>0005LP1250A</b>	1	0,211	11,35	99x55x92
7004A	REGULAR - blue plastic down-press wringer with plastic gears			1 pc.
7964A	Reinforced plastic push-bar for Arka trolley			1 pc.
8107B	Red plastic bucket 25 L with plastic handle			1 pc.
8332SS	Plastic frame with wheels ø 80 mm for Fred 50 L and Arka trolleys			1 pc.
P114011A	Supporting plastic plate for Arka trolley			1 pc.
P281001E	Set of two grey pushing grips (right and left) with reinforcements (right and left) and fixing screws for Arka trolley			1 pc.
P306010A	Plastic bagholder 100 L with bag-stretchers and cover with chek-list holder for Arka trolley			1 pc.



### ON REQUEST, WITH SURCHARGE



with 2 wheels 80 mm + 2 axial wheels 200 mm

TROLLEY REF. **0005LP2250A**

## ARKA 31 - plastic trolley 28 L



REF.	PCK	VOLUME (m³)	GROSS WEIGHT (kg)	SIZE (cm)
<b>0005LP1251A</b>	1	0,211	12,62	99x56x111
0000SE0104A	Blue plastic bucket 4 L with plastic handle			1 pc.
0000SE0104B	Red plastic bucket 4 L with plastic handle			1 pc.
0000SM00110U	FLIP - handle holder with rubber roll fitting plastic basket art. 60402A and plastic bucket holder art. P220001E			1 pc.
0000SM00215U	Hook fitting plastic basket art. 60402A and plastic bucket support art. P220001E			1 pc.
7004A	REGULAR - blue plastic down-press wringer with plastic gears			1 pc.
7964A	Reinforced plastic push-bar for Arka trolley			1 pc.
8107B	Red plastic bucket 25 L with plastic handle			1 pc.
8332SS	Plastic frame with wheels ø 80 mm for Fred 50 L and Arka trolleys			1 pc.
P114011A	Supporting plastic plate for Arka trolley			1 pc.
P120004E	Big support for plastic bucket holder art. P220001E			1 pc.
P220001E	Plastic bucket holder complete with supports (small and medium) for Vega and Arka trolleys			1 pc.
P281001E	Set of two grey pushing grips (right and left) with reinforcements (right and left) and fixing screws for Arka trolley			1 pc.
P306010A	Plastic bagholder 100 L with bag-stretchers and cover with chek-list holder for Arka trolley			1 pc.



### ON REQUEST, WITH SURCHARGE



with 2 wheels 80 mm + 2 axial wheels 200 mm

TROLLEY REF. **0005LP2251A**

## ARKA 32 - plastic trolley 28 L



REF.	PCK	VOLUME (m³)	GROSS WEIGHT (kg)	SIZE (cm)
<b>0005LP1252A</b>	1	0,211	13,17	99x60x111
0000SE0104A	Blue plastic bucket 4 L with plastic handle			1 pc.
0000SE0104B	Red plastic bucket 4 L with plastic handle			1 pc.
0000SM00110U	FLIP - handle holder with rubber roll fitting plastic basket art. 60402A and plastic bucket holder art. P220001E			1 pc.
0000SM00215U	Hook fitting plastic basket art. 60402A and plastic bucket support art. P220001E			1 pc.
7004A	REGULAR - blue plastic down-press wringer with plastic gears			1 pc.
7964A	Reinforced plastic push-bar for Arka trolley			1 pc.
8107B	Red plastic bucket 25 L with plastic handle			1 pc.
8332SS	Plastic frame with wheels ø 80 mm for Fred 50 L and Arka trolleys			1 pc.
P114011A	Supporting plastic plate for Arka trolley			1 pc.
P120004E	Big support for plastic bucket holder art. P220001E			1 pc.
P220001E	Plastic bucket holder complete with supports (small and medium) for Vega and Arka trolleys			1 pc.
P224002E	Plastic basket or bucket holder complete with supports for Vega and Arka trolleys			1 pc.
P281001E	Set of two grey pushing grips (right and left) with reinforcements (right and left) and fixing screws for Arka trolley			1 pc.
P306010A	Plastic bagholder 100 L with bag-stretchers and cover with chek-list holder for Arka trolley			1 pc.



### ON REQUEST, WITH SURCHARGE



with 2 wheels 80 mm + 2 axial wheels 200 mm

TROLLEY REF. **0005LP2252A**

BUCKETS AND WRINGER TROLLEYS

**ARKA 33 - plastic trolley 28 L**

REF.	PCK	VOLUME (m³)	GROSS WEIGHT (kg)	SIZE (cm)
<b>0005LP1253A</b>	1	0,211	13,59	99x65x111
0000SE0104A	Blue plastic bucket 4 L with plastic handle			1 pc.
0000SE0104B	Red plastic bucket 4 L with plastic handle			1 pc.
0000SM00110U	FLIP - handle holder with rubber roll fitting plastic basket art. 60402A and plastic bucket holder art. P220001E			1 pc.
0000SM00215U	Hook fitting plastic basket art. 60402A and plastic bucket support art. P220001E			1 pc.
7004A	REGULAR - blue plastic down-press wringer with plastic gears			1 pc.
7964A	Reinforced plastic push-bar for Arka trolley			1 pc.
8107B	Red plastic bucket 25 L with plastic handle			1 pc.
8332SS	Plastic frame with wheels ø 80 mm for Fred 50 L and Arka trolleys			1 pc.
P114011A	Supporting plastic plate for Arka trolley			1 pc.
P120004E	Big support for plastic bucket holder art. P220001E			1 pc.
P220001E	Plastic bucket holder complete with supports (small and medium) for Vega and Arka trolleys			1 pc.
P224002E	Plastic basket or bucket holder complete with supports for Vega and Arka trolleys			1 pc.
P225004A	Set of plastic paper holder with cover complete with 3 hooks			1 pc.
P281001E	Set of two grey pushing grips (right and left) with reinforcements (right and left) and fixing screws for Arka trolley			1 pc.
P306010A	Plastic bagholder 100 L with bag-stretchers and cover with chek-list holder for Arka trolley			1 pc.

**ON REQUEST, WITH SURCHARGE**

with 2 wheels 80 mm + 2 axial wheels 200 mm

**TROLLEY REF. 0005LP2253A**
**ARKA 34 - plastic trolley 28 L**

REF.	PCK	VOLUME (m³)	GROSS WEIGHT (kg)	SIZE (cm)
<b>0005LP1254A</b>	1	0,211	13,88	99x65x111
0000SE0104A	Blue plastic bucket 4 L with plastic handle			1 pc.
0000SE0104B	Red plastic bucket 4 L with plastic handle			1 pc.
0000SM00110U	FLIP - handle holder with rubber roll fitting plastic basket art. 60402A and plastic bucket holder art. P220001E			1 pc.
0000SM00215U	Hook fitting plastic basket art. 60402A and plastic bucket support art. P220001E			1 pc.
7004A	REGULAR - blue plastic down-press wringer with plastic gears			1 pc.
7964A	Reinforced plastic push-bar for Arka trolley			1 pc.
8107B	Red plastic bucket 25 L with plastic handle			1 pc.
8332SS	Plastic frame with wheels ø 80 mm for Fred 50 L and Arka trolleys			1 pc.
P114011A	Supporting plastic plate for Arka trolley			1 pc.
P120004E	Big support for plastic bucket holder art. P220001E			1 pc.
P120007A	Plastic quiver for polybags			1 pc.
P220001E	Plastic bucket holder complete with supports (small and medium) for Vega and Arka trolleys			1 pc.
P224002E	Plastic basket or bucket holder complete with supports for Vega and Arka trolleys			1 pc.
P225004A	Set of plastic paper holder with cover complete with 3 hooks			1 pc.
P281001E	Set of two grey pushing grips (right and left) with reinforcements (right and left) and fixing screws for Arka trolley			1 pc.
P306010A	Plastic bagholder 100 L with bag-stretchers and cover with chek-list holder for Arka trolley			1 pc.

**ON REQUEST, WITH SURCHARGE**

with 2 wheels 80 mm + 2 axial wheels 200 mm

**TROLLEY REF. 0005LP2254A**

# Buckets and wringer trolleys



PLASTIC MOP  
TROLLEYS

CHROMED AND RILSAN  
COATED TROLLEYS

BUCKET/WRINGER  
COMBOS

WRINGERS

MULTI-PURPOSE  
BUCKETS

TOP-DOWN® BUCKETS

OTHER PLASTIC  
BUCKETS

## ARKA 35 - plastic trolley 28 L

REF.	PCK	VOLUME (m <sup>3</sup> )	GROSS WEIGHT (kg)	SIZE (cm) ↓ ↓ ↓
<b>0005LP1255A</b>	1	0,211	14,11	99x65x111
0000SE0104A	Blue plastic bucket 4 L with plastic handle			1 pc.
0000SE0104B	Red plastic bucket 4 L with plastic handle			1 pc.
0000SM00110U	FLIP - handle holder with rubber roll fitting plastic basket art. 60402A and plastic bucket holder art. P220001E			1 pc.
0000SM00215U	Hook fitting plastic basket art. 60402A and plastic bucket support art. P220001E			1 pc.
7004A	REGULAR - blue plastic down-press wringer with plastic gears			1 pc.
7964A	Reinforced plastic push-bar for Arka trolley			1 pc.
8107B	Red plastic bucket 25 L with plastic handle			1 pc.
8332SS	Plastic frame with wheels ø 80 mm for Fred 50 L and Arka trolleys			1 pc.
P114011A	Supporting plastic plate for Arka trolley			1 pc.
P120004E	Big support for plastic bucket holder art. P220001E			1 pc.
P120007A	Plastic quiver for polybags			1 pc.
P120008A	Plastic quiver for window squeegees, washers, scrapers			1 pc.
P220001E	Plastic bucket holder complete with supports (small and medium) for Vega and Arka trolleys			1 pc.
P224002E	Plastic basket or bucket holder complete with supports for Vega and Arka trolleys			1 pc.
P225004A	Set of plastic paper holder with cover complete with 3 hooks			1 pc.
P281001E	Set of two grey pushing grips (right and left) with reinforcements (right and left) and fixing screws for Arka trolley			1 pc.
P306010A	Plastic bagholder 100 L with bag-stretchers and cover with chek-list holder for Arka trolley			1 pc.



### ON REQUEST, WITH SURCHARGE



with 2 wheels 80 mm + 2 axial  
wheels 200 mm

**TROLLEY REF.**  
**0005LP2255A**

## Vega and Arka Top-Down® trolleys

### VEGA TOP-DOWN® - plastic trolley



REF.	PCK	VOLUME (m³)	GROSS WEIGHT (kg)	SIZE (cm) ↓ ↓ ↓
<b>0000LP0321A2</b>	1	0,222	11,75	88x59x112
0000SE0104A	Blue plastic bucket 4 L with plastic handle			1 pc.
0000SE0104B	Red plastic bucket 4 L with plastic handle			1 pc.
0000SE1322A	TOP-DOWN® - blue plastic bucket 20 L with plastic handle and hermetic cover			1 pc.
0000SE1322B	TOP-DOWN® - red plastic bucket 20 L with plastic handle and hermetic cover			1 pc.
0000SM00102U	Hook fitting plastic push-bar art. 7964A - 7966A			1 pc.
0000SM00110U	FLIP - handle holder with rubber roll fitting plastic basket art. 60402A and plastic bucket holder art. P220001E			1 pc.
0000SM00215U	Hook fitting plastic basket art. 60402A and plastic bucket support art. P220001E			1 pc.
7966A	Reinforced push-bar for Orion and Vega trolleys			1 pc.
8335SS	Plastic frame with wheels ø 80 mm for Orion and Vega trolleys			1 pc.
P206002A	Bagholder 50 L for Vega trolley fitting plastic push-bar art. 7966A			1 pc.
P220001E	Plastic bucket holder complete with supports (small and medium) for Vega and Arka trolleys			1 pc.
R1050050	Rilsan coated broom/mop holder support for Orion and Vega trolleys			1 pc.
R1200103	Lower Rilsan coated bucket holder for buckets 20 L for Vega and Arka Top-Down trolleys			1 pc.
R1200104	Upper Rilsan coated bucket holder for buckets 20 L for Vega and Arka Top-Down trolleys			1 pc.



#### ACCESSORIES TO ORDER AS SEPARATE ITEMS

0000AT0110B	Red plastified bag 50 L			1 pc.
-------------	-------------------------	--	--	-------

### VEGA TOP-DOWN® - plastic trolley



REF.	PCK	VOLUME (m³)	GROSS WEIGHT (kg)	SIZE (cm) ↓ ↓ ↓
<b>0000LP0322A2</b>	1	0,172	9,3	90x59x112
0000SE0104A	Blue plastic bucket 4 L with plastic handle			1 pc.
0000SE0104B	Red plastic bucket 4 L with plastic handle			1 pc.
0000SE1308A	TOP-DOWN - blue plastic bucket 8 L with plastic handle and hermetic cover			1 pc.
0000SE1308B	TOP-DOWN - red plastic bucket 8 L with plastic handle and hermetic cover			1 pc.
0000SE1308C	TOP-DOWN - yellow plastic bucket 8 L with plastic handle and hermetic cover			1 pc.
0000SM00102U	Hook fitting plastic push-bar art. 7964A - 7966A			1 pc.
0000SM00110U	FLIP - handle holder with rubber roll fitting plastic basket art. 60402A and plastic bucket holder art. P220001E			1 pc.
0000SM00215U	Hook fitting plastic basket art. 60402A and plastic bucket support art. P220001E			1 pc.
7966A	Reinforced push-bar for Orion and Vega trolleys			1 pc.
8335SS	Plastic frame with wheels ø 80 mm for Orion and Vega trolleys			1 pc.
P206002A	Bagholder 50 L for Vega trolley fitting plastic push-bar art. 7966A			1 pc.
P220001E	Plastic bucket holder complete with supports (small and medium) for Vega and Arka trolleys			1 pc.
R1050050	Rilsan coated broom/mop holder support for Orion and Vega trolleys			1 pc.
R1200113	Lower Rilsan coated bucket holder for 2x 8 L buckets for Vega Top-Down trolley			1 pc.
R1200114	Upper Rilsan coated bucket holder for bucket 8 L for Vega Top-Down trolley			1 pc.



#### ACCESSORIES TO ORDER AS SEPARATE ITEMS

0000AT0110B	Red plastified bag 50 L			1 pc.
-------------	-------------------------	--	--	-------



# Buckets and wringer trolleys



PLASTIC MOP  
TROLLEYS

CHROMED AND RILSAN  
COATED TROLLEYS

BUCKET/WRINGER  
COMBOS

WRINGERS

MULTI-PURPOSE  
BUCKETS

TOP-DOWN® BUCKETS

OTHER PLASTIC  
BUCKETS

## ARKA TOP-DOWN® MIDI - plastic trolley



REF.	PCK	VOLUME (m³)	GROSS WEIGHT (kg)	SIZE (cm) ↓ ↓ ↓
<b>0000LP1211A2</b>	1	0,291	14,32	99x59x111
0000SE0104A	Blue plastic bucket 4 L with plastic handle			1 pc.
0000SE0104B	Red plastic bucket 4 L with plastic handle			1 pc.
0000SE1322B	TOP-DOWN® - red plastic bucket 20 L with plastic handle and hermetic cover			1 pc.
0000SM00110U	FLIP - handle holder with rubber roll fitting plastic basket art. 60402A and plastic bucket holder art. P220001E			1 pc.
0000SM00129U	Handle holder fitting plastic push-bar art. 7964A - 7966A			1 pc.
0000SM00215U	Hook fitting plastic basket art. 60402A and plastic bucket support art. P220001E			1 pc.
7964A	Reinforced plastic push-bar for Arka trolley			1 pc.
8332SS	Plastic frame with wheels ø 80 mm for Fred 50 L and Arka trolleys			1 pc.
P114011A	Supporting plastic plate for Arka trolley			1 pc.
P220001E	Plastic bucket holder complete with supports (small and medium) for Vega and Arka trolleys			1 pc.
P281001E	Set of two grey pushing grips (right and left) with reinforcements (right and left) and fixing screws for Arka trolley			1 pc.
P606010A	Plastic bagholder 2x50 L with bag-stretchers and cover with chek-list holder for Arka trolley			1 pc.
R1050040	Rilsan coated broom/mop holder support for Arka trolley			1 pc.
R1200104	Upper Rilsan coated bucket holder for buckets 20 L for Vega and Arka Top-Down trolleys			1 pc.



### ACCESSORIES TO ORDER AS SEPARATE ITEMS

0000AT0170A	Blue plastified bag 48x95 cm, capacity 60 L	1 pc.
0000AT0170B	Red plastic-coated bag 48x95 cm, maximum capacity 60 L	1 pc.

## ARKA TOP-DOWN® MAXI - plastic trolley



REF.	PCK	VOLUME (m³)	GROSS WEIGHT (kg)	SIZE (cm) ↓ ↓ ↓
<b>0000LP1221A2</b>	1	0,291	16,62	120x59x111
0000SE0104A	Blue plastic bucket 4 L with plastic handle			1 pc.
0000SE0104B	Red plastic bucket 4 L with plastic handle			1 pc.
0000SE1322A	TOP-DOWN® - blue plastic bucket 20 L with plastic handle and hermetic cover			1 pc.
0000SE1322B	TOP-DOWN® - red plastic bucket 20 L with plastic handle and hermetic cover			1 pc.
0000SM00110U	FLIP - handle holder with rubber roll fitting plastic basket art. 60402A and plastic bucket holder art. P220001E			1 pc.
0000SM00129U	Handle holder fitting plastic push-bar art. 7964A - 7966A			1 pc.
0000SM00215U	Hook fitting plastic basket art. 60402A and plastic bucket support art. P220001E			1 pc.
7964A	Reinforced plastic push-bar for Arka trolley			1 pc.
8332SS	Plastic frame with wheels ø 80 mm for Fred 50 L and Arka trolleys			1 pc.
P114011A	Supporting plastic plate for Arka trolley			1 pc.
P220001E	Plastic bucket holder complete with supports (small and medium) for Vega and Arka trolleys			1 pc.
P281001E	Set of two grey pushing grips (right and left) with reinforcements (right and left) and fixing screws for Arka trolley			1 pc.
P606010A	Plastic bagholder 2x50 L with bag-stretchers and cover with chek-list holder for Arka trolley			1 pc.
R1050040	Rilsan coated broom/mop holder support for Arka trolley			1 pc.
R1200103	Lower Rilsan coated bucket holder for buckets 20 L for Vega and Arka Top-Down trolleys			1 pc.
R1200104	Upper Rilsan coated bucket holder for buckets 20 L for Vega and Arka Top-Down trolleys			1 pc.



### ACCESSORIES TO ORDER AS SEPARATE ITEMS

0000AT0170A	Blue plastified bag 48x95 cm, capacity 60 L	1 pc.
0000AT0170B	Red plastic-coated bag 48x95 cm, maximum capacity 60 L	1 pc.



**PLASTIC MOP TROLLEYS**

CHROMED AND RILSAN COATED TROLLEYS

BUCKET/WRINGER COMBOS

WRINGERS

MULTI-PURPOSE BUCKETS

TOP-DOWN® BUCKETS

OTHER PLASTIC BUCKETS

## Components and accessories for plastic mop trolleys

Plastic frame with  $\varnothing$  80 mm wheels for OneFred 30 L and 50 L



REF.	NOTES
<b>8730YSS</b>	

Plastic frame with wheels  $\varnothing$  80 mm for Fred trolley 30 L



REF.	NOTES
<b>8331SS</b>	

Plastic frame with wheels  $\varnothing$  80 mm for Fred 50 L and Arka trolleys



REF.	NOTES
<b>8332SS</b>	

Plastic frame with wheels  $\varnothing$  80 mm for Orion and Vega trolleys



REF.	NOTES
<b>8335SS</b>	

Plastic frame with two wheels  $\varnothing$  80 mm and two wheels  $\varnothing$  200 mm for Arka trolley



REF.	NOTES
<b>8337SS</b>	

Plastic frame with two wheels  $\varnothing$  80 mm and two wheels  $\varnothing$  200 mm for Vega trolley



REF.	NOTES
<b>8338SS</b>	

BUCKETS AND WRINGER TROLLEYS

# Buckets and wringer trolleys



**PLASTIC MOP TROLLEYS**

CHROMED AND RILSAN COATED TROLLEYS

BUCKET/WRINGER COMBOS

WRINGERS

MULTI-PURPOSE BUCKETS

TOP-DOWN® BUCKETS

OTHER PLASTIC BUCKETS

Rilsan coated push-bar ø 18 mm for OneFred



REF.	NOTES
<b>R8061/2</b>	

Painted push-bar ø 18 mm for Fred trolley



REF.	NOTES
<b>R8061/1</b>	

Rilsan coated basket fitting the push-bar art. 8061/1 and R8061/2 for Fred and OneFred trolley



REF.	NOTES	SIZE (cm) ↓ ↓ ↓
<b>R8218</b>		18x35x14

Plastic grip for OneFred trolley



REF.	NOTES
<b>8731Y</b>	

Plastic grip for Orion and Fred trolleys



REF.	NOTES
<b>7963A</b>	

Reinforced push-bar for Orion and Vega trolleys



REF.	NOTES
<b>7966A</b>	

- PLASTIC MOP TROLLEYS
- CHROMED AND RILSAN COATED TROLLEYS
- BUCKET/WRINGER COMBOS
- WRINGERS
- MULTI-PURPOSE BUCKETS
- TOP-DOWN® BUCKETS
- OTHER PLASTIC BUCKETS

Bag holder 50 L for Vega trolley fitting plastic push-bar art. 7966A



REF.	NOTES
P206002A	

Plastic bag holder for Orion-Fred-Vega trolleys fitting push-bar art. 7963A and supports art. P290800A - P179002A



REF.	NOTES
P206003A	

Plastic support for plastic basket art. 60402A, paper holder art. P225004A and quivers



REF.	NOTES
P179002A	2. for bag holder art. P206002A of Vega trolley
P290800A	1. for Orion-Fred trolleys frame



Plastic carry basket for OneFred



REF.	NOTES
60406Y	

Plastic carry basket



REF.	NOTES	SIZE (cm)
60402A		↓ ↓ ↓ 32x13x14

Set of plastic paper holder with cover complete with 3 hooks



REF.	NOTES
P225004A	

BUCKETS AND WRINGER TROLLEYS

# Buckets and wringer trolleys



**PLASTIC MOP TROLLEYS**

CHROMED AND RILSAN COATED TROLLEYS

BUCKET/WRINGER COMBOS

WRINGERS

MULTI-PURPOSE BUCKETS

TOP-DOWN® BUCKETS

OTHER PLASTIC BUCKETS

## Plastic quiver for polybags



REF.	NOTES
P120007A	

## Plastic quiver for window squeegees, washers, scrapers



REF.	NOTES
P120008A	

## Bucket reduction for Orion trolley 15 L



REF.	NOTES
60295A	

## Reinforced plastic push-bar for Arka trolley



REF.	NOTES
7964A	

## Set of two grey pushing grips (right and left) with reinforcements (right and left) and fixing screws for Arka trolley



REF.	NOTES
P281001E	

## Supporting plastic plate for Arka trolley



REF.	NOTES
P114011A	



**PLASTIC MOP TROLLEYS**

CHROMED AND RILSAN COATED TROLLEYS

BUCKET/WRINGER COMBOS

WRINGERS

MULTI-PURPOSE BUCKETS

TOP-DOWN® BUCKETS

OTHER PLASTIC BUCKETS

Plastic bag holder complete with bag-stretchers and cover with chek-list holder for Arka trolley



REF.	NOTES
P306010A	100 L
P606010A	2x50 L

Plastic divider 2x50 L for bag holder art. P606010A for Arka trolley



REF.	NOTES
P206010E	

Plastic bucket holder complete with supports (small and medium) for Vega and Arka trolleys



REF.	NOTES
P220001E	

Big support for plastic bucket holder art. P220001E



REF.	NOTES
P120004E	

Plastic basket or bucket holder complete with supports for Vega and Arka trolleys



REF.	NOTES
P224002E	

Lower Rilsan coated bucket holder for buckets 20 L for Vega and Arka Top-Down® trolleys



REF.	NOTES
R1200103	

Upper Rilsan coated bucket holder for buckets 20 L for Vega and Arka Top-Down® trolleys



REF.	NOTES
R1200104	

# Buckets and wringer trolleys



**PLASTIC MOP TROLLEYS**

CHROMED AND RILSAN COATED TROLLEYS

BUCKET/WRINGER COMBOS

WRINGERS

MULTI-PURPOSE BUCKETS

TOP-DOWN® BUCKETS

OTHER PLASTIC BUCKETS

Lower Rilsan coated bucket holder for 2x 8 L buckets for Vega Top-Down® trolley



REF.	NOTES
R1200113	

Upper Rilsan coated bucket holder for bucket 8 L for Vega Top-Down® trolley



REF.	NOTES
R1200114	

Rilsan coated broom/mop holder support for Orion and Vega trolleys



REF.	NOTES
R1050050	

Rilsan coated broom/mop holder support for Arka trolley

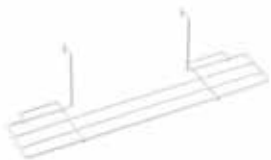

REF.	NOTES
R1050040	

Mop holder kit for OneFred trolleys

**NEW**



REF.	NOTES
0000SM00299	



OneFred trolley sign hook

**NEW**



REF.	NOTES
0000SM00248U	



BUCKETS AND WRINGER TROLLEYS

## Trolleys 25 L

### MINI JACK - chromed trolley 25 L



REF.	PCK	VOLUME (m <sup>3</sup> )	GROSS WEIGHT (kg)	SIZE (cm) ↓ ↓ ↓
<b>8010</b>	1	0,123	7,11	51x40x87
7004A	REGULAR - blue plastic down-press wringer with plastic gears			1 pc.
8008	Chromed frame with wheels ø 80 mm and bumpers			1 pc.
8107B	Red plastic bucket 25 L with plastic handle			1 pc.

### FILMOP - chromed trolley 25 L



REF.	PCK	VOLUME (m <sup>3</sup> )	GROSS WEIGHT (kg)	SIZE (cm) ↓ ↓ ↓
<b>8016</b>	1	0,133	8,59	56x40x98
7004A	REGULAR - blue plastic down-press wringer with plastic gears			1 pc.
8107B	Red plastic bucket 25 L with plastic handle			1 pc.
8205/1	Chromed basket for Mini Jack and Filmop trolleys			1 pc.
8316	Chromed frame with push-bar, wheels ø 80 mm and bumpers			1 pc.

## Trolleys 30 L

### JACK - chromed trolley 30 L



REF.	PCK	VOLUME (m <sup>3</sup> )	GROSS WEIGHT (kg)	SIZE (cm) ↓ ↓ ↓
<b>8024</b>	1	0,137	9,09	67x39x88
7004A	REGULAR - blue plastic down-press wringer with plastic gears			1 pc.
8062	Chromed push-bar for trolleys art. 8036, 8024 and 8010			1 pc.
8108A	Blue plastic bucket 15 L with plastic handle			1 pc.
8108B	Red plastic bucket 15 L with plastic handle			1 pc.
8300	Chromed frame with wheels ø 80 mm and bumpers			1 pc.

### JACK - Rilsan coated trolley 30 L



REF.	PCK	VOLUME (m <sup>3</sup> )	GROSS WEIGHT (kg)	SIZE (cm) ↓ ↓ ↓
<b>R8024</b>	1	0,137	9,09	67x39x88
7004A	REGULAR - blue plastic down-press wringer with plastic gears			1 pc.
8108A	Blue plastic bucket 15 L with plastic handle			1 pc.
8108B	Red plastic bucket 15 L with plastic handle			1 pc.
R8062	Rilsan coated push-bar for trolleys art. R8024 and R8036			1 pc.
R8300	Rilsan coated frame with wheels ø 80 mm and bumpers			1 pc.



# Buckets and wringer trolleys



PLASTIC MOP  
TROLLEYS

**CHROMED AND RILSAN  
COATED TROLLEYS**

BUCKET/WRINGER  
COMBOS

WRINGERS

MULTI-PURPOSE  
BUCKETS

TOP-DOWN® BUCKETS

OTHER PLASTIC  
BUCKETS

## FILMOP - chromed trolley 30 L



REF.	PCK	VOLUME (m <sup>3</sup> )	GROSS WEIGHT (kg)	SIZE (cm) ↓ ↓ ↓
<b>8017</b>	1	0,192	11,59	67x39x84
7004A	REGULAR - blue plastic down-press wringer with plastic gears			1 pc.
8108A	Blue plastic bucket 15 L with plastic handle			1 pc.
8108B	Red plastic bucket 15 L with plastic handle			1 pc.
8317	Chromed frame with push-bar, basket, bag holder, wheels ø 80 mm and bumpers			1 pc.

## FILMOP - Rilsan coated trolley 30 L



REF.	PCK	VOLUME (m <sup>3</sup> )	GROSS WEIGHT (kg)	SIZE (cm) ↓ ↓ ↓
<b>R8017</b>	1	0,192	11,59	67x39x84
7004A	REGULAR - blue plastic down-press wringer with plastic gears			1 pc.
8108A	Blue plastic bucket 15 L with plastic handle			1 pc.
8108B	Red plastic bucket 15 L with plastic handle			1 pc.
R8317	Rilsan coated frame with push-bar, basket, bagholder, wheels ø 80 mm and bumpers			1 pc.

## SCALA - chromed trolley 30 L



REF.	PCK	VOLUME (m <sup>3</sup> )	GROSS WEIGHT (kg)	SIZE (cm) ↓ ↓ ↓
<b>8020</b>	1	0,333	11,54	74x45x111
7004A	REGULAR - blue plastic down-press wringer with plastic gears			1 pc.
8108A	Blue plastic bucket 15 L with plastic handle			1 pc.
8108B	Red plastic bucket 15 L with plastic handle			1 pc.
8801	Chromed frame with two wheels ø 80 mm with bumpers and two wheels ø 185 mm			1 pc.

## Trolleys 50 L

### JACK - chromed trolley 50 L with revolving wringer



REF.	PCK	VOLUME (m <sup>3</sup> )	GROSS WEIGHT (kg)	SIZE (cm) ↓ ↓ ↓
<b>8032</b>	1	0,192	10,81	78x40x83
30055	Revolving chromed support			1 pc.
7004A	REGULAR - blue plastic down-press wringer with plastic gears			1 pc.
8062/1	Chromed push-bar for trolley art. 8032			1 pc.
8107A	Blue plastic bucket 25 L with plastic handle			1 pc.
8107B	Red plastic bucket 25 L with plastic handle			1 pc.
8314	Chromed frame with wheels ø 80 mm and bumpers			1 pc.

PLASTIC MOP TROLLEYS

**CHROMED AND RILSAN COATED TROLLEYS**

BUCKET/WRINGER COMBOS

WRINGERS

MULTI-PURPOSE BUCKETS

TOP-DOWN® BUCKETS

OTHER PLASTIC BUCKETS

## JACK - chromed trolley 50 L



REF.	PCK	VOLUME (m³)	GROSS WEIGHT (kg)	SIZE (cm) ↓ ↓ ↓
<b>8036</b>	1	0,178	9,59	73x40x93
7004A	REGULAR - blue plastic down-press wringer with plastic gears			1 pc.
8062	Chromed push-bar for trolleys art. 8036, 8024 and 8010			1 pc.
8107A	Blue plastic bucket 25 L with plastic handle			1 pc.
8107B	Red plastic bucket 25 L with plastic handle			1 pc.
8301	Chromed frame with wheels ø 80 mm and bumpers			1 pc.

## JACK - Rilsan coated trolley 50 L



REF.	PCK	VOLUME (m³)	GROSS WEIGHT (kg)	SIZE (cm) ↓ ↓ ↓
<b>R8036</b>	1	0,178	9,79	73x40x93
7004A	REGULAR - blue plastic down-press wringer with plastic gears			1 pc.
8107A	Blue plastic bucket 25 L with plastic handle			1 pc.
8107B	Red plastic bucket 25 L with plastic handle			1 pc.
R8062	Rilsan coated push-bar for trolleys art. R8024 and R8036			1 pc.
R8301	Rilsan coated frame with wheels ø 80 mm and bumpers			1 pc.

## FILMOP - chromed trolley 50 L



REF.	PCK	VOLUME (m³)	GROSS WEIGHT (kg)	SIZE (cm) ↓ ↓ ↓
<b>8018</b>	1	0,192	11,31	99x41x88
7004A	REGULAR - blue plastic down-press wringer with plastic gears			1 pc.
8028	Chromed frame with push-bar, basket, wheels ø 80 mm and bumpers			1 pc.
8107A	Blue plastic bucket 25 L with plastic handle			1 pc.
8107B	Red plastic bucket 25 L with plastic handle			1 pc.

## FILMOP - Rilsan coated trolley 50 L



REF.	PCK	VOLUME (m³)	GROSS WEIGHT (kg)	SIZE (cm) ↓ ↓ ↓
<b>R8018</b>	1	0,192	11,31	99x41x88
7004A	REGULAR - blue plastic down-press wringer with plastic gears			1 pc.
8107A	Blue plastic bucket 25 L with plastic handle			1 pc.
8107B	Red plastic bucket 25 L with plastic handle			1 pc.
R8028	Rilsan coated frame with push-bar, basket, wheels ø 80 mm and bumpers			1 pc.

# Buckets and wringer trolleys



PLASTIC MOP  
TROLLEYS

**CHROMED AND RILSAN  
COATED TROLLEYS**

BUCKET/WRINGER  
COMBOS

WRINGERS

MULTI-PURPOSE  
BUCKETS

TOP-DOWN® BUCKETS

OTHER PLASTIC  
BUCKETS

## Components and accessories for chromed and Rilsan coated trolleys

Chromed push-bar for trolleys art. 8036, 8024 and 8010



REF.	NOTES
<b>8062</b>	

Rilsan coated push-bar for trolleys art. R8024 and R8036



REF.	NOTES
<b>R8062</b>	

Chromed push-bar for trolley art. 8032



REF.	NOTES
<b>8062/1</b>	

Chromed basket for Mini Jack and Filmop trolleys



REF.	NOTES	SIZE (cm) ↓ ↓ ↓
<b>8205/1</b>		30,5x17,5x13,5

Chromed basket fitting push-bar for trolleys art. 8036, 8024 and 8010



REF.	NOTES	SIZE (cm) ↓ ↓ ↓
<b>8215</b>		33x19,5x14,5

Chromed basket for Filmop trolley art. 8018



REF.	NOTES	SIZE (cm) ↓ ↓ ↓
<b>C30152</b>		40x20x15,5

PLASTIC MOP TROLLEYS

CHROMED AND RILSAN COATED TROLLEYS

**BUCKET/WRINGER COMBOS**

WRINGERS

MULTI-PURPOSE BUCKETS

TOP-DOWN® BUCKETS

OTHER PLASTIC BUCKETS

## Single buckets

### JUMPY - single shockproof plastic bucket 30 L



REF.	PCK	VOLUME (m³)	GROSS WEIGHT (kg)	SIZE (cm) ↓ ↓ ↓
<b>0000SL2700C</b>	1	0,145	5,88	47x40x93

00SSSL2700C	Bucket 30 L with wheels for Jumpy bucket			1 pc.
7004A	REGULAR - blue plastic down-press wringer with plastic gears			1 pc.



### BABY - shockproof plastic single bucket 25 L



REF.	PCK	VOLUME (m³)	GROSS WEIGHT (kg)	SIZE (cm) ↓ ↓ ↓
<b>7970CGB</b>	1	0,106	6,35	46x41x80

7004A	REGULAR - blue plastic down-press wringer with plastic gears			1 pc.
7971CGBSS	Bucket 25 L with wheels for Baby bucket			1 pc.

### KING - shockproof plastic single bucket 15 L



REF.	PCK	VOLUME (m³)	GROSS WEIGHT (kg)	SIZE (cm) ↓ ↓ ↓
<b>7940CGB</b>	1	0,054	4,18	44x31x71

7941CGBSS	Bucket 15 L with wheels for King bucket			1 pc.
8002A	Plastic side-press wringer			1 pc.

### OSCAR - shockproof plastic single bucket 30 L



REF.	PCK	VOLUME (m³)	GROSS WEIGHT (kg)	SIZE (cm) ↓ ↓ ↓
<b>0000SL2602C</b>	1	0,145	6,47	55x37x93

00SSSL2602C	Bucket 30 L with wheels for Oscar bucket			1 pc.
7004A	REGULAR - blue plastic down-press wringer with plastic gears			1 pc.



PLASTIC MOP TROLLEYS

CHROMED AND RILSAN COATED TROLLEYS

**BUCKET/WRINGER COMBOS**

WRINGERS

MULTI-PURPOSE BUCKETS

TOP-DOWN® BUCKETS

OTHER PLASTIC BUCKETS

## **NEW** Duo Pro System



Duo Pro System is a **professional wringing system** consisting of a practical wringer and bucket. It's available with or without wheels, depending on specific needs.

Designed for use with the Duo Face reversible mop holder and the range of double-faced mops, it offers the **utmost efficiency** and **significant energy, time and cost savings**.

Duo Pro system is compatible with the Alpha trolley range.

- **It reduces strain:** the wringer is available in versions with **pressure wringing** and **lever wringing** system, for maximum ergonomics, convenience and ease of use
- **It saves time:** thanks to the combined efficiency of mop holder, mop and wringer, the system ensures **double cleaning** with **half the wringing** when compared with traditional systems
- **It reduces waste:** the high level of washing autonomy of microfibre allows to use **significantly less detergent**, therefore also decreasing the impact on the environment

BUCKETS AND WRINGER TROLLEYS

### Some features of Duo Pro system



Lever wringing ensures maximum results with minimum effort



Pressure wringing is comfortable, intuitive and easy to use

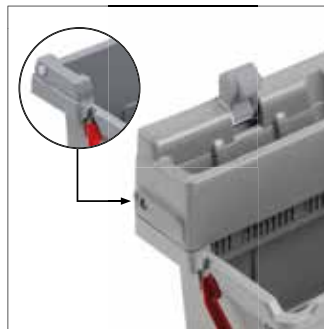

The buttons can be used to attach the wringer to the bucket

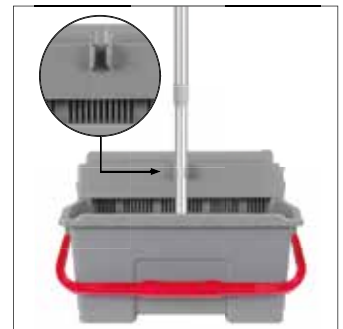

The hook can be used to secure the tool to the wringer

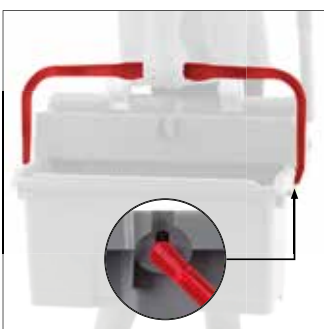

The oscillation prevention system ensures maximum stability



The coloured handles help differentiating bucket content



The reversible mop holder and the double-faced mops make cleaning easier: find out more in the Duo Face system section

PLASTIC MOP TROLLEYS

CHROMED AND RILSAN COATED TROLLEYS

**BUCKET/WRINGER COMBOS**

WRINGERS

MULTI-PURPOSE BUCKETS

TOP-DOWN® BUCKETS

OTHER PLASTIC BUCKETS

**DUO PRO SYSTEM** - 25l mop bucket with red handle complete with Duo Pro lever-operated wringer

**NEW**



REF.	NOTES	PCK	VOLUME (m³)	GROSS WEIGHT (kg)	SIZE (cm) ↓ ↓ ↓
<b>0020SE1725UB</b>	with castors	1	0,092	5,12	56x30,5x70,5
<b>0020SE0725UB</b>	without castors	1	0,092	4,74	56x30,5x63,5
0000SE0725UB	25l mop bucket with handle, grey with red handle				1 pc.
21040U	DUO PRO - lever plastic wringer				1 pc.
7949	Castor ø 50 mm				4 pcs

**DUO PRO SYSTEM** - 25l mop bucket with red handle complete with Duo Pro pressure wringer

**NEW**



REF.	NOTES	PCK	VOLUME (m³)	GROSS WEIGHT (kg)	SIZE (cm) ↓ ↓ ↓
<b>0010SE1725UB</b>	with castors	1	0,092	3,93	56x23x45
<b>0010SE0725UB</b>	without castors	1	0,092	2,66	56x23x38
0000SE0725UB	25l mop bucket with handle, grey with red handle				1 pc.
21030U	DUO PRO - pressure plastic wringer				1 pc.
7949	Castor ø 50 mm				4 pcs

## Take full advantage of the capacity of your bucket! SIEVE BOTTOM 21 CM FAR FROM BUCKET BOTTOM

**Master Lux** is designed to allow an accurate wring of the mop without the risk of soaking it again in the cleaning solution, as often happens with traditional buckets.

- Made with shockproof and recyclable polypropylene
- The plastic sieve rest onto the bucket edge thus bearing vigorous squeezing from the operator
- Drawing "caution wet floor" on the sides of the bucket
- Graduated from 0 to 16 L
- Bottom protection rim to make the emptying of the bucket easier
- Available in blue, red, yellow and green
- Easily transportable in all multipurpose trolleys
- Used for the cleaning of small environments



**MASTER LUX** - plastic bucket 16 L with handle and sieve



REF.	NOTES	PCK	VOLUME (m³)	GROSS WEIGHT (kg)	SIZE (cm) ↓ ↓ ↓
<b>2080A</b>		10	0,113	8,03	36x27x35
<b>2080B</b>		10	0,113	8,03	36x27x35
<b>2080C</b>		10	0,113	8,03	36x27x35
<b>2080F</b>		10	0,113	8,03	36x27x35

**PLUTO** - plastic bucket 12 L with handle and sieve



REF.	NOTES	PCK	VOLUME (m³)	GROSS WEIGHT (kg)	SIZE (cm) ↓ ↓ ↓
<b>2070A</b>		12	0,114	7,25	35x28x30
<b>2070B</b>		12	0,114	7,25	35x28x30
<b>2070C</b>		12	0,114	7,25	35x28x30
<b>2070F</b>		12	0,114	7,25	35x28x30

# Buckets and wringer trolleys



PLASTIC MOP TROLLEYS

CHROMED AND RILSAN COATED TROLLEYS

**BUCKET/WRINGER COMBOS**

WRINGERS

MULTI-PURPOSE BUCKETS

TOP-DOWN® BUCKETS

OTHER PLASTIC BUCKETS

**Twice** is the double bucket with wringer for professional floor wet mopping, designed to guarantee the best service and profitability during cleaning operations.

It has a total 30 L capacity and it is equipped **with two drain-plugs**; thanks to its two compartments, it separates clean solution from rinsing water.

The bucket can be piled up thanks to the plastic feet that can be easily unassembled saving transport and storing costs.

It fits all Filmop plastic wringers.



Two compartments 16 L + 14 L



Two separate drain-plugs



Stackable

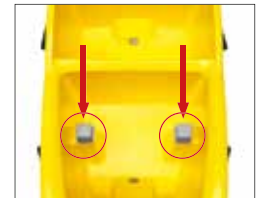

Specific wringer adaptor-plugs for Punto and Deep wringers

## Buckets with divider for water separation

**TWICE** - shockproof plastic bucket 30 L with two drain-plugs and Regular wringer



REF.	PCK	VOLUME (m³)	GROSS WEIGHT (kg)	SIZE (cm) ↓ ↓ ↓
<b>0000SL2800C</b>	1	0,142	6,23	60x40x93
00SSSL2800C	Bucket 16+14 L with wheels and two drain-plugs for Twice bucket			1 pc.
7004A	REGULAR - blue plastic down-press wringer with plastic gears			1 pc.

**TWICE** - shockproof plastic bucket 30 L with two drain-plugs and Punto wringer



REF.	PCK	VOLUME (m³)	GROSS WEIGHT (kg)	SIZE (cm) ↓ ↓ ↓
<b>0022SL2800C</b>	1	0,142	7,24	60x40x93
0000SM00031U	Set of 2 grey adaptor-plugs 1A+2A for wringers art. 14000-12000-10000			1 pc.
00SSSL2800C	Bucket 16+14 L with wheels and two drain-plugs for Twice bucket			1 pc.
14000A	PUNTO - roll plastic wringer, central position			1 pc.

**TWICE** - shockproof plastic bucket 30 L with two drain-plugs and Deep wringer



REF.	PCK	VOLUME (m³)	GROSS WEIGHT (kg)	SIZE (cm) ↓ ↓ ↓
<b>0006SL2800C</b>	1	0,142	6,44	60x40x93
0000SM00030C	Set of 2 yellow adaptor-plugs 1B+2B for wringer art. 7002			1 pc.
00SSSL2800C	Bucket 16+14 L with wheels and two drain-plugs for Twice bucket			1 pc.
7002A	DEEP - plastic side press wringer without bottom			1 pc.

PLASTIC MOP TROLLEYS

CHROMED AND RILSAN COATED TROLLEYS

**BUCKET/WRINGER COMBOS**

WRINGERS

MULTI-PURPOSE BUCKETS

TOP-DOWN® BUCKETS

OTHER PLASTIC BUCKETS

## MAXI JOLLY - shockproof plastic single bucket 30 L with divider and drain-plug



REF.	PCK	VOLUME (m³)	GROSS WEIGHT (kg)	SIZE (cm) ↓ ↓ ↓
<b>0000SL2601C</b>	1	0,145	7,52	55x37x93
00SSSL2601C	Bucket 30 L whit drain-plug, divider and wheels for Maxi Jolly bucket			1 pc.
7002A	DEEP - plastic side press wringer without bottom			1 pc.



## SPIDER - shockproof plastic single bucket 15 L with divider



REF.	PCK	VOLUME (m³)	GROSS WEIGHT (kg)	SIZE (cm) ↓ ↓ ↓
<b>7930AGB</b>		1	0,057	47x27x71
<b>7930CGB</b>		1	0,057	47x27x71
7931CGBSS	Yellow bucket 15 L with divider and wheels for Spider bucket			1 pc.
8002/1A	Plastic side-press wringer with plastic covering			1 pc.



## SPIDER MAX - shockproof plastic single bucket 15 L with divider



REF.	PCK	VOLUME (m³)	GROSS WEIGHT (kg)	SIZE (cm) ↓ ↓ ↓
<b>7990AGB</b>		1	0,094	55x27x87
<b>7990CGB</b>		1	0,094	55x27x87
42100A	Bucket support for Spider Max with pirouetting wheels ø 50 mm			1 pc.
60152A	Blue divider for Spider bucket			1 pc.
7932AGB	Blue bucket 15 L without divider and without wheels for Spider bucket			1 pc.
8002/1A	Plastic side-press wringer with plastic covering			1 pc.



## RO-CKET WHEELS - single plastic bucket 15 L with rubber rolls, divider and wheels



REF.	NOTES	PCK	VOLUME (m³)	GROSS WEIGHT (kg)	SIZE (cm) ↓ ↓ ↓
<b>0000LP1402C</b>		1	0,074	3,87	44x32x41



# Buckets and wringer trolleys



PLASTIC MOP TROLLEYS

CHROMED AND RILSAN COATED TROLLEYS

**BUCKET/WRINGER COMBOS**

WRINGERS

MULTI-PURPOSE BUCKETS

TOP-DOWN® BUCKETS

OTHER PLASTIC BUCKETS

**RO-CKET** - single plastic bucket 15 L with rubber rolls and divider



REF.	NOTES	PCK	VOLUME (m³)	GROSS WEIGHT (kg)	SIZE (cm) ↓ ↓ ↓
0000LP1401C		1	0,063	3,33	44x32x35

**Gemini** is Filmop smallest professional cleaning system. It is composed of two compartments to separate rinsing water from cleaning solution. It is equipped with two handles for a better stability of the bucket during transport.



All buckets have a bottom protection rim and an ergonomic seizing to empty the bucket easier.



They can be carried very easily on all multipurpose trolleys.

**GEMINI** - plastic bucket 15 L with 2 compartments, 2 handles and sieve

REF.	NOTES	PCK	VOLUME (m³)	GROSS WEIGHT (kg)	SIZE (cm) ↓ ↓ ↓
2060A		6	0,101	8,59	42x28x33
2060B		6	0,101	8,59	42x28x33



BUCKETS AND WRINGER TROLLEYS

PLASTIC MOP TROLLEYS

CHROMED AND RILSAN COATED TROLLEYS

**BUCKET/WRINGER COMBOS**

WRINGERS

MULTI-PURPOSE BUCKETS

TOP-DOWN® BUCKETS

OTHER PLASTIC BUCKETS

## Wringer bucket components and accessories

### Bucket 30 L with wheels for Jumpy bucket



REF.	NOTES
00SSSL2700C	

### Bucket 25 L with wheels for Baby bucket



REF.	NOTES
7971CGBSS	

### Bucket 15 L with wheels for King bucket



REF.	NOTES	SIZE (cm)
7941CGBSS		↓↓↓ 44x31x34,5

### Bucket 30 L with wheels for Oscar bucket



REF.	NOTES
00SSSL2602C	

### Bucket 16+14 L with wheels and two drain-plugs for Twice bucket



REF.	NOTES
00SSSL2800C	

If it is used with wringers art. 7002, 14000 and 8004, you have to use the relative wringer adaptor-plugs

### Set of adaptor-plugs for wringer



REF.	NOTES	
0000SM00030C	1B+2B - for wringer art. 7002	
0000SM00031U	1A+2A - for wringers art. 14000-12000-10000	
0000SM00032H	1C+2C - for wringer art. 8004	

# Buckets and wringer trolleys



PLASTIC MOP TROLLEYS

CHROMED AND RILSAN COATED TROLLEYS

**BUCKET/WRINGER COMBOS**

WRINGERS

MULTI-PURPOSE BUCKETS

TOP-DOWN® BUCKETS

OTHER PLASTIC BUCKETS

## Valve for Twice bucket



REF.	NOTES
P190301H	

## Bucket 30 L whit drain-plug, divider and wheels for Maxi Jolly bucket



REF.	NOTES
00SSSL2601C	

## Divider with 2 lift levers and rubber profile for Maxi Jolly bucket



REF.	NOTES
P390300C	



## Valve for Maxi Jolly bucket



REF.	NOTES
P190371H	



## Bucket 15 L with divider and wheels for Spider bucket



REF.	NOTES
7931AGBSS	
7931CGBSS	

## Bucket 15 L without divider and without wheels for Spider bucket



REF.	NOTES
7932AGB	
7932CGB	



PLASTIC MOP TROLLEYS

CHROMED AND RILSAN COATED TROLLEYS

**BUCKET/WRINGER COMBOS**

WRINGERS

MULTI-PURPOSE BUCKETS

TOP-DOWN® BUCKETS

OTHER PLASTIC BUCKETS

## Divider for Spider bucket



REF.	NOTES
60152A	
60152C	

## Bucket support for Spider Max with pirouetting wheels ø 50 mm



REF.	NOTES
42100A	

## Plastic 25l mop bucket for Duo Pro wringer

**NEW**



REF.	NOTES	SIZE (cm) ↓ ↓ ↓
0000SE0725UB	without castors	56x30,5x26
0000SE1725UB	with castors	56x30,5x33

## Plastic bucket 15 L with 2 compartments and 2 plastic handles for Gemini bucket



REF.	NOTES	PCK	VOLUME (m³)	GROSS WEIGHT (kg)	SIZE (cm) ↓ ↓ ↓
2061A		6	0,101	7,22	42x28x27,5
2061B		6	0,101	7,22	42x28x27,5

## Plastic sieve for Gemini bucket



REF.	NOTES
2062A	
2062B	

## Plastic bucket 16 L with plastic handle for Master Lux bucket



REF.	NOTES	PCK	VOLUME (m³)	GROSS WEIGHT (kg)	SIZE (cm) ↓ ↓ ↓
2051A		10	0,113	8,03	35x27,5x27,5
2051B		10	0,113	8,03	35x27,5x27,5
2051C		10	0,113	8,03	35x27,5x27,5
2051F		10	0,113	8,03	35x27,5x27,5

BUCKETS AND WRINGER TROLLEYS

# Buckets and wringer trolleys



PLASTIC MOP  
TROLLEYS

CHROMED AND RILSAN  
COATED TROLLEYS

**BUCKET/WRINGER  
COMBOS**

WRINGERS

MULTI-PURPOSE  
BUCKETS

TOP-DOWN® BUCKETS

OTHER PLASTIC  
BUCKETS

## Plastic sieve for Master Lux bucket



REF.	NOTES
2082A	
2082B	
2082C	
2082F	

## Plastic bucket 12 L with plastic handle for Pluto bucket



REF.	NOTES	PCK	VOLUME (m³)	GROSS WEIGHT (kg)	SIZE (cm) ↓ ↓ ↓
2071A		12	0,114	5,81	35x28x23,5
2071B		12	0,114	5,81	35x28x23,5
2071C		12	0,114	5,81	35x28x23,5
2071F		12	0,114	5,81	35x28x23,5

## Plastic sieve for Pluto bucket



REF.	NOTES
2072A	
2072B	
2072C	
2072F	

PLASTIC MOP TROLLEYS

CHROMED AND RILSAN COATED TROLLEYS

BUCKET/WRINGER COMBOS

**WRINGERS**

MULTI-PURPOSE BUCKETS

TOP-DOWN® BUCKETS

OTHER PLASTIC BUCKETS

**Regular** wringer is composed of a polypropylene structure and gears. The jaws go all the way down to the bottom of the wringer, allowing a perfect wringing both of string mops (till 450 gr) and of flat wet mops. It is equipped with a revolving handle holder and a front cover in order to avoid unpleasant dripping while squeezing.

**Regular** fits any kind of wet mopping system.



Washing



Rinsing



Wringing

BUCKETS AND WRINGER TROLLEYS

## Regular wringer

**REGULAR** - plastic down-press wringer with plastic gears



REF.	NOTES	PCK	VOLUME (m³)	GROSS WEIGHT (kg)
7004A		135	2,9	264,87
7004E		135	2,9	264,87

## Components and accessories for Regular

Plastic jaw for Regular wringer



REF.	NOTES
8640	

Rotating handle holder for wringers art. 7004, 8000 and 8004



REF.	NOTES
8599	

# Buckets and wringer trolleys



PLASTIC MOP TROLLEYS

CHROMED AND RILSAN COATED TROLLEYS

BUCKET/WRINGER COMBOS

**WRINGERS**

MULTI-PURPOSE BUCKETS

TOP-DOWN® BUCKETS

OTHER PLASTIC BUCKETS

## Plastic vertical gear for Regular wringer



REF.	NOTES
60500	right vertical gear
60501	left vertical gear

## Plastic round gear for Regular wringer



REF.	NOTES
60502	Right gear
60503	Left gear

## Aluminium pin for Regular wringer



REF.	NOTES
V8643	

## Chromed metal handle with plastic grip for Regular wringer



REF.	NOTES
A8644A	

## Inside spring for Regular wringer



REF.	NOTES
8645	

## Fixing clip



REF.	NOTES
60005A	

PLASTIC MOP TROLLEYS

CHROMED AND RILSAN COATED TROLLEYS

BUCKET/WRINGER COMBOS

**WRINGERS**

MULTI-PURPOSE BUCKETS

TOP-DOWN® BUCKETS

OTHER PLASTIC BUCKETS

**Punto** wringer has been conceived without bottom in order to rinse and wring the flat mops directly through the wringer into the bucket, reducing working time and avoiding unpleasant dripping on the floor. It is equipped with a painted metal handle with return spring making its use easier.



Washing



Rinsing



Wringing

Version with adjustable roll, designed to increase the technical performances, flexibility and efficiency.

Now it is possible to regulate the roll position very easily in order to adapt the roll to any wet mopping system employing 40 cm flat mops and to different wringing requirements.



**Filmop will go on supplying it with the requested roll position according to your needs:**

**POSITION -**



Art. 12000A:  
for a lighter wringing performance

**CENTRAL POSITION**



Art. 14000A:  
for all types of mops and for a standard wringing performance

**POSITION +**



Art. 10000A:  
for a stronger wringing performance

## Punto wringer

**PUNTO** - plastic wringer with adjustable roll



REF.	NOTES	PCK	VOLUME (m³)	GROSS WEIGHT (kg)
10000A	roll with position "+" (for a stronger wringing performance)	1	0,028	3,42
12000A	roll with position "-" (for a lighter wringing performance)	1	0,028	3,42
14000A	roll with central position (for a standard wringing performance)	1	0,028	3,42





PLASTIC MOP  
TROLLEYS

CHROMED AND RILSAN  
COATED TROLLEYS

BUCKET/WRINGER  
COMBOS

**WRINGERS**

MULTI-PURPOSE  
BUCKETS

TOP-DOWN® BUCKETS

OTHER PLASTIC  
BUCKETS

## Components and accessories for Punto

### Universal rubber roll ø 48 mm for Punto wringer



REF.	NOTES
<b>P1780029U</b>	

### Roll support with covering for Punto wringer



REF.	NOTES
<b>P2780060</b>	

### Stainless steel pin for roll of Punto wringer



REF.	NOTES
<b>V1010801</b>	

### Inside spring for Punto wringer



REF.	NOTES
<b>U100007</b>	

### Set of gears for Punto wringer



REF.	NOTES
<b>P2780030</b>	left set
<b>P2780040</b>	right set

### Painted metal handle for Punto wringer



REF.	NOTES
<b>P278006A</b>	

### Aluminium pin for handle for Punto wringer



REF.	NOTES
<b>A1110810</b>	

### Fixing clip



REF.	NOTES
<b>60005A</b>	

### Handle holder for Punto wringer



REF.	NOTES
<b>P1780010</b>	

PLASTIC MOP TROLLEYS

CHROMED AND RILSAN COATED TROLLEYS

BUCKET/WRINGER COMBOS

**WRINGERS**

MULTI-PURPOSE BUCKETS

TOP-DOWN® BUCKETS

OTHER PLASTIC BUCKETS



**Deep** wringer has been conceived without bottom in order to rinse and wring the flat mop directly through the wringer into the bucket, reducing working time and unpleasant dripping on the floor during rinsing and wringing.

It is equipped with a revolving handle holder and spray protection front cover. It is advised to wring both string mops of any weight and flat wet mops.

**Deep** fits any kind of wet mopping system.



Washing



Rinsing



Wringing

## Deep wringer

**DEEP** - plastic side press wringer without bottom



REF.	NOTES	PCK	VOLUME (m³)	GROSS WEIGHT (kg)
7002A		1	0,028	2,56

## Components and accessories for Deep

Painted metal handle for Deep wringer



REF.	NOTES
8633A	

Painted pin for Deep wringer



REF.	NOTES
V8632	

Covering for Deep wringer



REF.	NOTES
60356A	

# Buckets and wringer trolleys



PLASTIC MOP  
TROLLEYS

CHROMED AND RILSAN  
COATED TROLLEYS

BUCKET/WRINGER  
COMBOS

**WRINGERS**

MULTI-PURPOSE  
BUCKETS

TOP-DOWN® BUCKETS

OTHER PLASTIC  
BUCKETS

## Plastic connecting rod for Deep wringer



REF.	NOTES
60307A	right connecting rod
60308A	left connecting rod

## Rotating handle holder for Deep wringer



REF.	NOTES
60311H	

## Spring for Deep wringer



REF.	NOTES
8154	

## Fixing clip



REF.	NOTES
60005A	

## Side-press wringers

### Plastic side-press wringer with plastic covering



REF.	NOTES	PCK	VOLUME (m³)	GROSS WEIGHT (kg)
8002/1A		10	0,178	19,66

### Plastic side-press wringer



REF.	NOTES	PCK	VOLUME (m³)	GROSS WEIGHT (kg)
8002A		105	2,064	182,7

PLASTIC MOP  
TROLLEYS

CHROMED AND RILSAN  
COATED TROLLEYS

BUCKET/WRINGER  
COMBOS

**WRINGERS**

MULTI-PURPOSE  
BUCKETS

TOP-DOWN® BUCKETS

OTHER PLASTIC  
BUCKETS

## Components and accessories for wringers art. 8002 and 8002-1

Chromed metal handle with plastic grip for wringers art. 8002 and 8002/1



REF.	NOTES
<b>8617A</b>	

Painted pin for wringers art. 8002 and 8002/1



REF.	NOTES
<b>V8618</b>	

Reducer for wringer art. 8002



REF.	NOTES
<b>8623E</b>	

Covering for wringers art. 8002 and 8002/1



REF.	NOTES
<b>60156A</b>	

Plastic connecting rod for wringers art. 8002 and 8002/1



REF.	NOTES
<b>60107A</b>	right connecting rod
<b>60108A</b>	left connecting rod

Spring 81 mm for wringers art. 8002 and 8002/1



REF.	NOTES
<b>8151</b>	

Fixing clip



REF.	NOTES
<b>60005A</b>	



PLASTIC MOP  
TROLLEYS

CHROMED AND RILSAN  
COATED TROLLEYS

BUCKET/WRINGER  
COMBOS

**WRINGERS**

MULTI-PURPOSE  
BUCKETS

TOP-DOWN® BUCKETS

OTHER PLASTIC  
BUCKETS

## Wringers with jaws

Plastic down-press wringer with galvanized metal gears



REF.	NOTES	PCK	VOLUME (m³)	GROSS WEIGHT (kg)
<b>8000A</b>		12	0,275	47,68

Plastic down-press wringer with plastic gears



REF.	NOTES	PCK	VOLUME (m³)	GROSS WEIGHT (kg)
<b>8004A</b>		12	0,275	36,88

## Components and accessories for wringers art. 8000 and 8004

Jaw for wringers art. 8000 and 8004



REF.	NOTES
<b>8066</b>	

Rotating handle holder for wringers art. 7004, 8000 and 8004



REF.	NOTES
<b>8599</b>	

Aluminium pin for plastic round gear for wringer art. 8004



REF.	NOTES
<b>0000SLA30401</b>	long
<b>0000SLA30402</b>	short

Galvanized metal handle for wringers art. 8000 and 8004



REF.	NOTES
<b>8608/1</b>	

PLASTIC MOP TROLLEYS

CHROMED AND RILSAN COATED TROLLEYS

BUCKET/WRINGER COMBOS

**WRINGERS**

MULTI-PURPOSE BUCKETS

TOP-DOWN® BUCKETS

OTHER PLASTIC BUCKETS

Handle fixing flanges with screws for wringers art. 8000 and 8004



REF.	NOTES
<b>8613</b>	

Plastic round gear for wringer art. 8000



REF.	NOTES
<b>60059</b>	Right gear
<b>60060</b>	Left gear

Plastic vertical gear for wringer art. 8004



REF.	NOTES
<b>60057</b>	right vertical gear

Inside spring 184 mm for wringers art. 8000 and 8004



REF.	NOTES
<b>8068</b>	

Round galvanized metal gear with pin for wringer art. 8000



REF.	NOTES
<b>Z30132</b>	with short pin
<b>Z30133</b>	with long pin

Vertical galvanized metal gear for wringer art. 8000



REF.	NOTES
<b>Z30130</b>	right vertical gear
<b>Z30131</b>	left vertical gear

Reducer for wringers art. 8000 and 8004



REF.	NOTES
<b>8601</b>	



PLASTIC MOP TROLLEYS

CHROMED AND RILSAN COATED TROLLEYS

BUCKET/WRINGER COMBOS

**WRINGERS**

MULTI-PURPOSE BUCKETS

TOP-DOWN® BUCKETS

OTHER PLASTIC BUCKETS

## **NEW** Duo Pro wringer

Duo Pro is a practical and intuitive **professional wringer** designed for easier cleaning with less effort. It's available with both pressure and lever wringing system, both designed for maximum **ergonomics, convenience** and **ease of use**.

The Duo Pro wringer and its bucket expand and complete the **Duo Face system** consisting of **reversible mop holder** and the range of **double-faced mops**.



Lever wringer

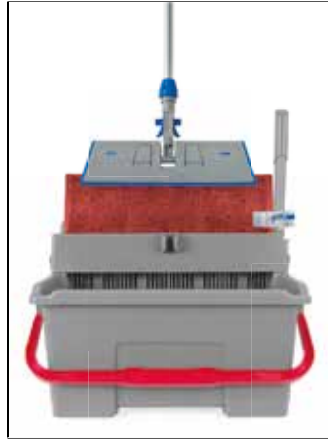

Pressure wringer

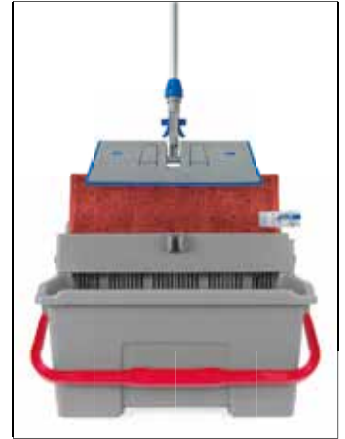

BUCKET AND WRINGER TROLLEYS

## Duo Pro wringers

**DUO PRO** - plastic lever-operated wringer for DuoFace system

**NEW**



REF.	NOTES	PCK	VOLUME (m³)	GROSS WEIGHT (kg)	SIZE (cm) ↓ ↓ ↓
21040U		4	0,073	9,77	55x14,5x45

**DUO PRO** - plastic pressure wringer for DuoFace system

**NEW**



REF.	NOTES	PCK	VOLUME (m³)	GROSS WEIGHT (kg)	SIZE (cm) ↓ ↓ ↓
21030U		2	0,03	2,88	55x14,5x19

Filmop is always designing and increasing its range of practical, handy and compact cleaning tools, ideal for the simple cleaning in environments with **reduced transit or storage areas**.

Filmop **Prisma** bucket, a developed and improved version of the traditional 28-litre bucket, is equipped with a **new cross double handle** (PAT PENDING) shaped specifically to keep and block the handle during the transport of the bucket, thus keeping the tools inside the bucket stable and safe. It is available also with **pirouetting wheels** to transport it easily.

Prisma can be **customized** on request by adding several easily removable snap-in multifunctional accessories and compartments for product storage, for surface cleaning or for floor wet mopping.

Choose the best solution and combination to satisfy your cleaning requirements!



## Prisma bucket

### PRISMA - plastic bucket 28 L with double handle



REF.	NOTES	PCK	VOLUME (m³)	GROSS WEIGHT (kg)	SIZE (cm)
0000SE0628U		10	0,225	15,92	57,5x38x27

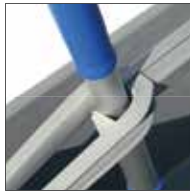

### PRISMA - plastic bucket 28 L with double handle and wheels



REF.	NOTES	PCK	VOLUME (m³)	GROSS WEIGHT (kg)	SIZE (cm)
0000SE1628U		1	0,092	2,92	57,5x38x34

### PRISMA - plastic bucket 28 L with double handle and 2 rectangular plastic baskets 6 L



REF.	NOTES	PCK	VOLUME (m³)	GROSS WEIGHT (kg)	SIZE (cm)
0010SE0628U		1	0,092	3,38	57,5x38x28,5

### PRISMA - plastic bucket 28 L with double handle, 2 rectangular plastic baskets 6 L and sieve



REF.	NOTES	PCK	VOLUME (m³)	GROSS WEIGHT (kg)	SIZE (cm)
0020SE0628U		1	0,092	3,52	57,5x38x35



# Buckets and wringer trolleys



PLASTIC MOP  
TROLLEYS

CHROMED AND RILSAN  
COATED TROLLEYS

BUCKET/WRINGER  
COMBOS

WRINGERS

**MULTI-PURPOSE  
BUCKETS**

TOP-DOWN® BUCKETS

OTHER PLASTIC  
BUCKETS

## Components and accessories for Prisma bucket

### Plastic cover for bucket 28 L



REF.	NOTES	SIZE (cm) ↓ ↓ ↓
0000CP1128U		53x33x2,8

### Rectangular plastic basket 6 L with coloured slots



REF.	NOTES	PCK	VOLUME (m³)	GROSS WEIGHT (kg)	SIZE (cm) ↓ ↓ ↓
P0190047UA		10	0,041	5,32	33x13x26,5
P0190047UB		10	0,041	5,32	33x13x26,5

### Plastic sieve for rectangular basket 6 L



REF.	NOTES
21005U	



### Plastic cover for rectangular basket 6 L



REF.	NOTES	SIZE (cm) ↓ ↓ ↓
P0190049U		29,8x13,5



### Stainless steel sieve for rectangular basket 6 L



REF.	NOTES	SIZE (cm) ↓ ↓ ↓
I2190039		24,5x9,5



PLASTIC MOP TROLLEYS

CHROMED AND RILSAN COATED TROLLEYS

BUCKET/WRINGER COMBOS

WRINGERS

**MULTI-PURPOSE BUCKETS**

TOP-DOWN® BUCKETS

OTHER PLASTIC BUCKETS

Plastic basket with 3 compartments complete with cover and handle



REF.	NOTES	PCK	VOLUME (m³)	GROSS WEIGHT (kg)	SIZE (cm) ↓ ↓ ↓
P1190048UB		5	0,055	3,89	33x13,5x20,5

Toilet brush



REF.	NOTES	PCK	VOLUME (m³)	GROSS WEIGHT (kg)
9148		20	0,024	3,94

Rectangular tool with strips 2,5 cm for velcro system, with Lock System



REF.	NOTES	PCK	VOLUME (m³)	GROSS WEIGHT (kg)	SIZE (cm) ↓ ↓ ↓
5390U		10	0,011	2,23	20x8

**MICRO-ACTIVA** - microfiber mop with backing for velcro system



REF.	NOTES	PCK	VOLUME (m³)	GROSS WEIGHT (kg)	SIZE (cm) ↓ ↓ ↓
0000PN01010		25	0,011	0,97	25x10

**TOP-CLEAN** - plastic mop holder with grip and strips 2,5 cm for velcro system



REF.	NOTES	PCK	VOLUME (m³)	GROSS WEIGHT (kg)	SIZE (cm) ↓ ↓ ↓
5233U		10	0,016	1,98	30
5234U		10	0,019	2,1	40

Ultra-microfiber cloths with backing for velcro system



REF.	NOTES	PCK	VOLUME (m³)	GROSS WEIGHT (kg)	SIZE (cm) ↓ ↓ ↓
0000PN02016		25	0,005	0,99	30x11
0000PN03016		25	0,011	1,49	40x11

Ideal for stainless steel surfaces, mirrors and windows

# Buckets and wringer trolleys



PLASTIC MOP TROLLEYS

CHROMED AND RILSAN COATED TROLLEYS

BUCKET/WRINGER COMBOS

WRINGERS

**MULTI-PURPOSE BUCKETS**

TOP-DOWN® BUCKETS

OTHER PLASTIC BUCKETS

Wheel ø 50 mm



REF.	NOTES
7949	for King, Spider, Ro-cket Wheels, Prisma, Twin, Top-Down®, Pick-Up, Trend and art. 0000SE1428

Wheel ø 35 mm



REF.	NOTES
2793	for Prisma, Twin, Top-Down®, Pick-Up, Trend and art. 0000SE1428

## Twin bucket

**TWIN** - plastic bucket 2x10 L with two plastic handles



REF.	NOTES	PCK	VOLUME (m³)	GROSS WEIGHT (kg)	SIZE (cm) ↓ ↓ ↓
7914A		5	0,132	8,79	45x36x26



Fitting window washer 35 cm

Plastic sieve for Twin bucket



REF.	NOTES
21021A	

Plastic sieve for Twin bucket



REF.	NOTES
21002	

Available while stocks last

Plastic lid for Twin bucket



REF.	NOTES
60294U	



PLASTIC MOP  
TROLLEYS

CHROMED AND RILSAN  
COATED TROLLEYS

BUCKET/WRINGER  
COMBOS

WRINGERS

**MULTI-PURPOSE  
BUCKETS**

TOP-DOWN® BUCKETS

OTHER PLASTIC  
BUCKETS

## Set of holders for plastic cover for Twin bucket



REF.	NOTES
7915A	

## Wheel ø 35 mm



REF.	NOTES
2793	for Prisma, Twin, Top-Down®, Pick-Up, Trend and art. 0000SE1428

## Wheel ø 50 mm



REF.	NOTES
7949	for King, Spider, Ro-cket Wheels, Prisma, Twin, Top-Down®, Pick-Up, Trend and art. 0000SE1428

# Buckets and wringer trolleys



PLASTIC MOP TROLLEYS

CHROMED AND RILSAN COATED TROLLEYS

BUCKET/WRINGER COMBOS

WRINGERS

MULTI-PURPOSE BUCKETS

**TOP-DOWN® BUCKETS**

OTHER PLASTIC BUCKETS

The **Top-Down®** buckets are equipped with an **hermetic cover**. They are ideal for pre-soaking, that is to say the preparation beforehand of the mops for the cleaning/wet mopping of floors and surfaces.



Hermetic system.



Quick and easy snap.



The plastic divider is ideal to keep the mops compact and to make it easier to pick them with the mop holder.



The pierced plastic sieve allows a uniform distribution of the cleaning solution, very important for a faster soaking.



Pre-soaking with 8-litre Top-Down® buckets for the cleaning of surfaces using the Top-Clean system.

## Top-Down® buckets complete

**TOP-DOWN®** - plastic bucket with plastic handle and hermetic cover



REF.	NOTES	CAPACITY (L)	PCK	VOLUME (m³)	GROSS WEIGHT (kg)	SIZE (cm) ↓ ↓ ↓
0000SE1308A		8	5	0,043	3,5	36x17x23
0000SE1308B		8	5	0,043	3,5	36x17x23
0000SE1308C		8	5	0,043	3,5	36x17x23
0000SE1310A		10	5	0,094	7,45	55x24x19
0000SE1310B		10	5	0,094	7,45	55x24x19
0000SE1314A		14	4	0,086	6,63	77x20x18
0000SE1314B		14	4	0,086	6,63	77x20x18
0000SE1314FT		14	4	0,086	6,63	77x20x18
0000SE1322A		20	4	0,094	6,93	55x24x27
0000SE1322B		20	4	0,094	6,93	55x24x27
0000SE1322U		20	4	0,094	6,93	55x24x27

## Components and accessories for Top-Down®

### Plastic bucket 8 L with plastic handle



REF.	NOTES	PCK	VOLUME (m <sup>3</sup> )	GROSS WEIGHT (kg)	SIZE (cm) ↓ ↓ ↓
0000SE1208A		9	0,048	4,76	36x17x23
0000SE1208B		9	0,048	4,76	36x17x23
0000SE1208C		9	0,048	4,76	36x17x23

### Plastic bucket 10 L with plastic handle



REF.	NOTES	PCK	VOLUME (m <sup>3</sup> )	GROSS WEIGHT (kg)	SIZE (cm) ↓ ↓ ↓
0000SE1210A		12	0,169	12	55x24x19
0000SE1210B		12	0,169	12	55x24x19

### Plastic bucket 14 L with plastic handle



REF.	NOTES	PCK	VOLUME (m <sup>3</sup> )	GROSS WEIGHT (kg)	SIZE (cm) ↓ ↓ ↓
0000SE1214A		10	0,148	11,25	77x20x18
0000SE1214B		10	0,148	11,25	77x20x18
0000SE1214FT		10	0,148	11,25	77x20x18

### Plastic bucket 20 L with plastic handle



REF.	NOTES	PCK	VOLUME (m <sup>3</sup> )	GROSS WEIGHT (kg)	SIZE (cm) ↓ ↓ ↓
0000SE1222A		10	0,169	12,19	55x24x27
0000SE1222B		10	0,169	12,19	55x24x27
0000SE1222U		10	0,169	12,19	55x24x27

### Hermetic plastic cover for Top-Down® bucket



REF.	NOTES
0000CP1108U	for bucket 8 L
0000CP1114U	for bucket 14 L
0000CP1122U	for bucket 10 and 20 L

### Plastic divider for Top-Down® bucket 20 L



REF.	NOTES	PCK	VOLUME (m <sup>3</sup> )	GROSS WEIGHT (kg)
P190350E		5	0,024	2,67



# Buckets and wringer trolleys



PLASTIC MOP TROLLEYS

CHROMED AND RILSAN COATED TROLLEYS

BUCKET/WRINGER COMBOS

WRINGERS

MULTI-PURPOSE BUCKETS

**TOP-DOWN® BUCKETS**

OTHER PLASTIC BUCKETS

## Pierced plastic sieve for Top-Down® bucket

REF.	NOTES	PCK	VOLUME (m³)	GROSS WEIGHT (kg)	SIZE (cm) ↓ ↓ ↓
<b>P1190041U</b>	for Top-Down® 8 L	9	-	1,52	33,3x14,2x2,2
<b>P1190042U</b>	for Top-Down® 10 and 20 L	10	0,031	4,24	54x20x3



Ideal for a uniform distribution of the cleaning solution - For a quick pre-soaking (max 15 minutes)

## Stainless steel sieve for Top-Down® bucket 20 L



REF.	NOTES
<b>I2190044</b>	

## Plastic sieve for Top-Down® bucket 10 and 20 L



REF.	NOTES
<b>21004</b>	



## Wheel ø 35 mm



REF.	NOTES
<b>2793</b>	for Prisma, Twin, Top-Down®, Pick-Up, Trend and art. 0000SE1428

## Wheel ø 50 mm



REF.	NOTES
<b>7949</b>	for King, Spider, Ro-cket Wheels, Prisma, Twin, Top-Down®, Pick-Up, Trend and art. 0000SE1428

PLASTIC MOP TROLLEYS

CHROMED AND RILSAN COATED TROLLEYS

BUCKET/WRINGER COMBOS

WRINGERS

MULTI-PURPOSE BUCKETS

TOP-DOWN® BUCKETS

**OTHER PLASTIC BUCKETS**

## Other buckets

### Plastic bucket 25 L with plastic handle



REF.	NOTES	SIZE (cm) ↓ ↓ ↓
8107A		36,2x32,4x31,7
8107B		36,2x32,4x31,7

### Grey plastic 25l mop bucket with coloured plastic handle for OneFred

**NEW**



REF.	NOTES	SIZE (cm) ↓ ↓ ↓
0000SE0125UA		36,8x40,5x32,3
0000SE0125UB		36,8x40,5x32,3

### Plastic bucket 15 L with plastic handle



REF.	NOTES	SIZE (cm) ↓ ↓ ↓
8108A		34x33,5x28,3
8108B		34x33,5x28,3

### Grey plastic 15l mop bucket with coloured plastic handle for OneFred

**NEW**



REF.	NOTES	SIZE (cm) ↓ ↓ ↓
0000SE0115UA		32,5x32,7x32
0000SE0115UB		32,5x32,7x32

### Plastic bucket 12 L with plastic handle



REF.	NOTES	SIZE (cm) ↓ ↓ ↓
8211/1A		32,5x27,7x26
8211/1B		32,5x27,7x26

### Plastic bucket 8 L with plastic handle on the edge



REF.	NOTES	SIZE (cm) ↓ ↓ ↓
0000SE0108A		33x16x23,5
0000SE0108B		33x16x23,5
0000SE0108C		33x16x23,5



# Buckets and wringer trolleys



PLASTIC MOP TROLLEYS

CHROMED AND RILSAN COATED TROLLEYS

BUCKET/WRINGER COMBOS

WRINGERS

MULTI-PURPOSE BUCKETS

TOP-DOWN® BUCKETS

OTHER PLASTIC BUCKETS

## Plastic bucket 6 L with plastic handle



REF.	NOTES	SIZE (cm) ↓ ↓ ↓
8218A		26x20,8x21,5
8218B		26x20,8x21,5
8218C		26x20,8x21,5
8218F		26x20,8x21,5

## Grey plastic bucket 6 L with coloured short plastic handle



REF.	NOTES	SIZE (cm) ↓ ↓ ↓
0000SE0106U		26x21x23,5
0000SE0106UA		26x21x23,5
0000SE0106UB		26x21x23,5
0000SE0106UC		26x21x23,5
0000SE0106UF		26x21x23,5

## Plastic bucket 4 L with plastic handle



REF.	NOTES	SIZE (cm) ↓ ↓ ↓
0000SE0104A		25,5x17x19,5
0000SE0104B		25,5x17x19,5
0000SE0104C		25,5x17x19,5
0000SE0104F		25,5x17x19,5

## Grey plastic bucket 4 L with coloured plastic handle on the edge



REF.	NOTES	SIZE (cm) ↓ ↓ ↓
0000SE0204U		21x16,5x22,5
0000SE0204UA		21x16,5x22,5
0000SE0204UB		21x16,5x22,5
0000SE0204UC		21x16,5x22,5
0000SE0204UF		21x16,5x22,5

## Plastic bucket 28 L with 2 plastic handles and removable divider



REF.	NOTES	SIZE (cm) ↓ ↓ ↓
0000SE1128B		32,5x44,5x31,5

## Plastic bucket 28 L with plastic handle



REF.	NOTES	SIZE (cm) ↓ ↓ ↓
0000SE1428A		52x32x27
0000SE1428B		52x32x27



PLASTIC MOP TROLLEYS

CHROMED AND RILSAN COATED TROLLEYS

BUCKET/WRINGER COMBOS

WRINGERS

MULTI-PURPOSE BUCKETS

TOP-DOWN® BUCKETS

OTHER PLASTIC BUCKETS

## Plastic bucket 16 L with plastic handle for Master Lux bucket



REF.	NOTES	PCK	VOLUME (m³)	GROSS WEIGHT (kg)	SIZE (cm) ↓ ↓ ↓
2051A		10	0,113	8,03	35x27,5x27,5
2051B		10	0,113	8,03	35x27,5x27,5
2051C		10	0,113	8,03	35x27,5x27,5
2051F		10	0,113	8,03	35x27,5x27,5

## Plastic bucket 12 L with plastic handle for Pluto bucket



REF.	NOTES	PCK	VOLUME (m³)	GROSS WEIGHT (kg)	SIZE (cm) ↓ ↓ ↓
2071A		12	0,114	5,81	35x28x23,5
2071B		12	0,114	5,81	35x28x23,5
2071C		12	0,114	5,81	35x28x23,5
2071F		12	0,114	5,81	35x28x23,5

## Accessories for other buckets

### Set of 3 stickers for buckets

REF.	NOTES
3048	



### Wringer with roll for microfiber cloths fitting buckets 6 L and 4 L



REF.	NOTES	PCK	VOLUME (m³)	GROSS WEIGHT (kg)	SIZE (cm) ↓ ↓ ↓
16000A		10	0,097	14,58	35x12,5x22



### Pierced plastic sieve for buckets

REF.	NOTES
P1190044U	for bucket 6 L
P1190050U	for bucket 4 L art. 0000SE0104



# Buckets and wringer trolleys



PLASTIC MOP TROLLEYS

CHROMED AND RILSAN COATED TROLLEYS

BUCKET/WRINGER COMBOS

WRINGERS

MULTI-PURPOSE BUCKETS

TOP-DOWN® BUCKETS

OTHER PLASTIC BUCKETS

## Plastic sieve for buckets 25 L



REF.	NOTES
21003	



## Transparent plastic cover



REF.	NOTES
60222	for bucket 4 L art. 0000SE0104
60232	for bucket 6 L
60230	for bucket 12 L



## Transparent plastic cover with hinges



REF.	NOTES
0000CP1204T	for bucket 4 L art. 0000SE0104
0000CP1205T	for 4l bucket item no. 0000SE0204
0000CP1206T	for bucket 6 L



## Hermetic transparent plastic cover for buckets 4 L art. 0000SE0104



REF.	NOTES
0000CP1104T	



Ideal for pre-soaked cloths on roll

## Plastic divider for basket art. P1199900U - bucket support art. P220001E - buckets 4 L art. 0000SE0104



REF.	NOTES
P1909932U	





PLASTIC MOP  
TROLLEYS

CHROMED AND RILSAN  
COATED TROLLEYS

BUCKET/WRINGER  
COMBOS

WRINGERS

MULTI-PURPOSE  
BUCKETS

TOP-DOWN® BUCKETS

**OTHER PLASTIC  
BUCKETS**

## Plastic cover for bucket 28 L



REF.	NOTES	SIZE (cm) ↓ ↓ ↓
0000CP1128U		53x33x2,8

## Wheel ø 35 mm



REF.	NOTES
2793	for Prisma, Twin, Top-Down®, Pick-Up, Trend and art. 0000SE1428

## Wheel ø 50 mm



REF.	NOTES
7949	for King, Spider, Rocket Wheels, Prisma, Twin, Top-Down®, Pick-Up, Trend and art. 0000SE1428



## Waste collection

Plastic bag holders

Chrome waste bag holder trolleys

Paper holders

Bins for large areas

Bins for separate waste collection

Sanitary bins





- PLASTIC BAG HOLDERS**
- CHROME WASTE BAG HOLDER TROLLEYS
- PAPER HOLDERS
- BINS FOR LARGE AREAS
- BINS FOR SEPARATE WASTE COLLECTION
- SANITARY BINS

## Alpha trolleys

### ALPHA 1102 - plastic trolley



REF.	PCK	VOLUME (m³)	GROSS WEIGHT (kg)	SIZE (cm)
<b>0000MA1102U00</b>	1	0,177	14,21	97x58x102
0000SM00163	Set of T-shaped dark grey closing plugs for vertical frames (6 pcs)			1 pc.
P059011U	Short base with wheels ø 100 mm			1 pc.
P165000U	Base extension for Alpha trolleys and for the bag supporting plastic plate of the Morgan Hotel Elegance trolleys			1 pc.
P2031103U	Vertical frame with reinforcement, 1 smooth side + 1 side for T-plugs, complete with screws			1 pc.
P8161110U	120l waste bag holder, female fitting, with dustpan hook and handle clip			1 pc.
P8161111U	120l waste bag holder, male fitting, with dustpan hook and handle clip			1 pc.

#### ACCESSORIES TO ORDER AS SEPARATE ITEMS

3650A	Blue plastified bag 73x97,5 cm, capacity 120 L	1 pc.
3650B	Red plastified bag 73x97,5 cm, capacity 120 L	1 pc.
P291918A	Blue cover for bag holder 120 L	1 pc.
P291918B	Red cover for bag holder 120 L	1 pc.

#### ON REQUEST, WITH SURCHARGE

	Rubber wheels ø 125 mm		Wheel ø 125 mm		Foldable bag holder 120 L
<b>TROLLEY REF. 0000MA1302U00</b>		<b>TROLLEY REF. 0000MA1602U00</b>		<b>TROLLEY REF. 0300MA1102U00</b>	

### ALPHA 2107 - plastic trolley



REF.	PCK	VOLUME (m³)	GROSS WEIGHT (kg)	SIZE (cm)
<b>0500MA2107U00</b>	1	0,261	19,05	126x58x102
0000SM00165	Set of T-shaped light grey closing plugs for vertical frames (6 pcs)			2 pc.
P059011U	Short base with wheels ø 100 mm			1 pc.
P165000U	Base extension for Alpha trolleys and for the bag supporting plastic plate of the Morgan Hotel Elegance trolleys			1 pc.
P175000U	Supporting plastic plate for Alpha trolleys			1 pc.
P2039903E	Vertical frame, 1 side with slides + 1 side for T-plugs, complete with screws and plugs			2 pc.
P8161113U	Folding 120l waste bag holder, with bag retaining hooks, dustpan hook, handle clip, screws and plugs			2 pc.
P8169903U	Central bag holder 150 L (female-female version)			1 pc.

#### ACCESSORIES TO ORDER AS SEPARATE ITEMS

0000AT0190E	Grey plastified bag 79x98 cm, capacity 150 L	1 pc.
3650A	Blue plastified bag 73x97,5 cm, capacity 120 L	1 pc.
3650B	Red plastified bag 73x97,5 cm, capacity 120 L	1 pc.
P291918A	Blue cover for bag holder 120 L	1 pc.
P291918B	Red cover for bag holder 120 L	1 pc.
P2919943U	Cover for central bag holder 150 L	1 pc.

#### ON REQUEST, WITH SURCHARGE

	Rubber wheels ø 125 mm		Wheel ø 125 mm
<b>TROLLEY REF. 0500MA2307U00</b>		<b>TROLLEY REF. 0500MA2607U00</b>	



## PLASTIC BAG HOLDERS

CHROME WASTE BAG HOLDER TROLLEYS

PAPER HOLDERS

BINS FOR LARGE AREAS

BINS FOR SEPARATE WASTE COLLECTION

SANITARY BINS

### ALPHA 5143 - plastic trolley



### ALPHA 0901006 - plastic trolley



REF.	PCK	VOLUME (m³)	GROSS WEIGHT (kg)	SIZE (cm) ↓ ↓ ↓
<b>0300MA5143U00</b>	1	0,261	18,15	133x58x102
0000SM00165	Set of T-shaped light grey closing plugs for vertical frames (6 pcs)	2 pc.		
P066011U	Long base with wheels ø 100 mm	1 pc.		
P175000U	Supporting plastic plate for Alpha trolleys	1 pc.		
P2039903E	Vertical frame, 1 side with slides + 1 side for T-plugs, complete with screws and plugs	2 pc.		
P8161111U	120l waste bag holder, male fitting, with dustpan hook and handle clip	1 pc.		
P8161113U	Folding 120l waste bag holder, with bag retaining hooks, dustpan hook, handle clip, screws and plugs	1 pc.		
P8169903U	Central bag holder 150 L (female-female version)	1 pc.		

REF.	PCK	VOLUME (m³)	GROSS WEIGHT (kg)	SIZE (cm) ↓ ↓ ↓
<b>MA0901006U000</b>	1	0,27	22,27	146x58x102
0000SM00165	Set of T-shaped light grey closing plugs for vertical frames (6 pcs)	2 pc.		
P066011U	Long base with wheels ø 100 mm	1 pc.		
P175000U	Supporting plastic plate for Alpha trolleys	2 pc.		
P2039903E	Vertical frame, 1 side with slides + 1 side for T-plugs, complete with screws and plugs	2 pc.		
P8161113U	Folding 120l waste bag holder, with bag retaining hooks, dustpan hook, handle clip, screws and plugs	2 pc.		
P8169906U	Set of 2 bag holders 150 L complete with screws and plugs	1 pc.		

### ACCESSORIES TO ORDER AS SEPARATE ITEMS

0000AT0190E	Grey plastified bag 79x98 cm, capacity 150 L	1 pc.
3650A	Blue plastified bag 73x97,5 cm, capacity 120 L	1 pc.
3650B	Red plastified bag 73x97,5 cm, capacity 120 L	1 pc.
P291918A	Blue cover for bag holder 120 L	1 pc.
P291918B	Red cover for bag holder 120 L	1 pc.
P2919943U	Cover for central bag holder 150 L	1 pc.

### ACCESSORIES TO ORDER AS SEPARATE ITEMS

0000AT0190E	Grey plastified bag 79x98 cm, capacity 150 L	2 pc.
3650A	Blue plastified bag 73x97,5 cm, capacity 120 L	1 pc.
3650B	Red plastified bag 73x97,5 cm, capacity 120 L	1 pc.
P291918A	Blue cover for bag holder 120 L	1 pc.
P291918B	Red cover for bag holder 120 L	1 pc.
P2919943U	Cover for central bag holder 150 L	2 pc.

### ON REQUEST, WITH SURCHARGE

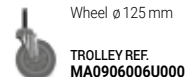
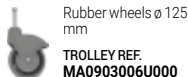
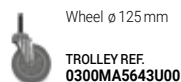

### ON REQUEST, WITH SURCHARGE



- PLASTIC BAG HOLDERS
- CHROME WASTE BAG HOLDER TROLLEYS
- PAPER HOLDERS
- BINS FOR LARGE AREAS
- BINS FOR SEPARATE WASTE COLLECTION
- SANITARY BINS

## ALPHA 7103 - plastic trolley



REF.	PCK	VOLUME (m³)	GROSS WEIGHT (kg)	SIZE (cm) ↓ ↓ ↓
<b>0000MA7103U00</b>	1	0,261	21,85	105x58x102
0000SM00165	Set of T-shaped light grey closing plugs for vertical frames (6 pcs)	1 pc.		
P066011U	Long base with wheels ø 100 mm	1 pc.		
P2039903E	Vertical frame, 1 side with slides + 1 side for T-plugs, complete with screws and plugs	1 pc.		
P2909912U	Divider for bag holder 150 L	2 pc.		
P2909946A	Blue cover for bag holder 150 L with check list holder	1 pc.		
P2909946B	Red cover for bag holder 150 L with check list holder	1 pc.		
P3059953E	Fixed side wall with fixing pins	4 pcs		
P3909952E	Door with fixing pins for bag holder	2 pc.		
P8169900U	150l waste bag holder, female fitting, with 2 Uni-Move clips, 2 long supports with sign hook, 2 pistons, screws and plugs for Alpha 7103 trolley	1 pc.		
P8169901U	150l waste bag holder, male fitting, with 2 Uni-Move clips, 2 long supports with sign hook, 2 pistons, screws and plugs for Alpha 7103 trolley	1 pc.		

### ACCESSORIES TO ORDER AS SEPARATE ITEMS

0000AT0160A	Blue plastic-coated bag 57x98 cm, maximum capacity 80 L	2 pc.
0000AT0160B	Red plastified bag 57x98 cm, capacity 80 L	2 pc.
P2909915U	Pedal set for Alpha trolleys with long base or compact, closed bag holder 150 L and wheels ø 100 mm	1 pc.

### ON REQUEST, WITH SURCHARGE

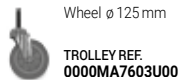

## ALPHA 8125 - plastic trolley



REF.	PCK	VOLUME (m³)	GROSS WEIGHT (kg)	SIZE (cm) ↓ ↓ ↓
<b>1000MA8125U00</b>	1	0,372	30,77	146x58x102
0000SM00165	Set of T-shaped light grey closing plugs for vertical frames (6 pcs)	2 pc.		
P066011U	Long base with wheels ø 100 mm	1 pc.		
P2039903E	Vertical frame, 1 side with slides + 1 side for T-plugs, complete with screws and plugs	2 pc.		
P2909912U	Divider for bag holder 150 L	3 pcs		
P2909946A	Blue cover for bag holder 150 L with check list holder	1 pc.		
P2909946B	Red cover for bag holder 150 L with check list holder	1 pc.		
P2919943U	Cover for central bag holder 150 L	1 pc.		
P3059953E	Fixed side wall with fixing pins	5 pcs		
P3059954E	Right door with fixing pins	1 pc.		
P3909952E	Door with fixing pins for bag holder	2 pc.		
P515010U	Supporting plastic plate with 2 wheels ø 100 mm and 2 blocking clips	1 pc.		
P8169903U	Central bag holder 150 L (female-female version)	1 pc.		
P8169905U	150l waste bag holder for Alpha standard and 90l for AlphaSplit, male fitting, with hooks, pistons, screws and plugs	2 pc.		

### ACCESSORIES TO ORDER AS SEPARATE ITEMS

0000AT0160A	Blue plastic-coated bag 57x98 cm, maximum capacity 80 L	2 pc.
0000AT0160B	Red plastified bag 57x98 cm, capacity 80 L	3 pcs
0000AT0160E	Grey plastified bag 57x98 cm, capacity 80 L	1 pc.
P2909915U	Pedal set for Alpha trolleys with long base or compact, closed bag holder 150 L and wheels ø 100 mm	2 pc.

### ON REQUEST, WITH SURCHARGE

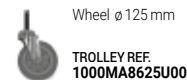





- PLASTIC BAG HOLDERS
- CHROME WASTE BAG HOLDER TROLLEYS
- PAPER HOLDERS
- BINS FOR LARGE AREAS
- BINS FOR SEPARATE WASTE COLLECTION
- SANITARY BINS

## ALPHA 0901005 - plastic trolley



REF.	PCK	VOLUME (m³)	GROSS WEIGHT (kg)	SIZE (cm)
<b>MA0901005U002</b>	1	0,488	29,54	146x58x102
0000SM00165	Set of T-shaped light grey closing plugs for vertical frames (6 pcs)			2 pc.
P066011U	Long base with wheels ø 100 mm			1 pc.
P2039903E	Vertical frame, 1 side with slides + 1 side for T-plugs, complete with screws and plugs			2 pc.
P2909946A	Blue cover for bag holder 150 L with check list holder			1 pc.
P2909946B	Red cover for bag holder 150 L with check list holder			1 pc.
P2919943U	Cover for central bag holder 150 L			1 pc.
P3119953E	Fixed side wall with "plastic" design, with fixing pins			2 pc.
P3129953E	Fixed side wall with "glass" design, with fixing pins			1 pc.
P3129954E	Right door with "glass" design, with fixing pins			1 pc.
P3139953E	Fixed side wall with "paper" design, with fixing pins			2 pc.
P3909952E	Door with fixing pins for bag holder			2 pc.
P515010U	Supporting plastic plate with 2 wheels ø 100 mm and 2 blocking clips			1 pc.
P8169903U	Central bag holder 150 L (female-female version)			1 pc.
P8169905U	150l waste bag holder for Alpha standard and 90l for AlphaSplit, male fitting, with hooks, pistons, screws and plugs			2 pc.

### ACCESSORIES TO ORDER AS SEPARATE ITEMS

0000AT0190A	Blue plastified bag 150 L, 79x98 cm	1 pc.
0000AT0190B	Red plastified bag 150 L, 79x98 cm	1 pc.
0000AT0190E	Grey plastified bag 79x98 cm, capacity 150 L	1 pc.
P2909915U	Pedal set for Alpha trolleys with long base or compact, closed bag holder 150 L and wheels ø 100 mm	2 pc.

### ON REQUEST, WITH SURCHARGE

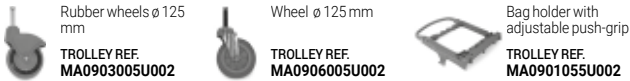

Rubber wheels ø 125 mm  
TROLLEY REF. **MA0903005U002**

Wheel ø 125 mm  
TROLLEY REF. **MA0906005U002**

Bag holder with adjustable push-grip  
TROLLEY REF. **MA0901055U002**

## ALPHA 0901019 - plastic trolley



REF.	PCK	VOLUME (m³)	GROSS WEIGHT (kg)	SIZE (cm)
<b>MA0901019U000</b>	1	0,488	35,64	194x58x102
0000SM00165	Set of T-shaped light grey closing plugs for vertical frames (6 pcs)			2 pc.
P066011U	Long base with wheels ø 100 mm			1 pc.
P2039903E	Vertical frame, 1 side with slides + 1 side for T-plugs, complete with screws and plugs			2 pc.
P2039904E	Vertical frame, 2 sides with slides, complete with screws and plugs			1 pc.
P2909912U	Divider for bag holder 150 L			4 pcs
P2909946A	Blue cover for bag holder 150 L with check list holder			1 pc.
P2909946B	Red cover for bag holder 150 L with check list holder			1 pc.
P2919943U	Cover for central bag holder 150 L			2 pc.
P3059953E	Fixed side wall with fixing pins			6 pcs
P3059954E	Right door with fixing pins			1 pc.
P3059974E	Left door with fixing pins			1 pc.
P3909952E	Door with fixing pins for bag holder			2 pc.
P515010U	Supporting plastic plate with 2 wheels ø 100 mm and 2 blocking clips			2 pc.
P8169903U	Central bag holder 150 L (female-female version)			1 pc.
P8169904U	Central bag holder 150 L (male-female version) complete with screws and plugs			1 pc.
P8169905U	150l waste bag holder for Alpha standard and 90l for AlphaSplit, male fitting, with hooks, pistons, screws and plugs			2 pc.

### ACCESSORIES TO ORDER AS SEPARATE ITEMS

0000AT0160A	Blue plastic-coated bag 57x98 cm, maximum capacity 80 L	2 pc.
0000AT0160B	Red plastified bag 57x98 cm, capacity 80 L	4 pcs
0000AT0160E	Grey plastified bag 57x98 cm, capacity 80 L	2 pc.
P2909915U	Pedal set for Alpha trolleys with long base or compact, closed bag holder 150 L and wheels ø 100 mm	2 pc.

### ON REQUEST, WITH SURCHARGE

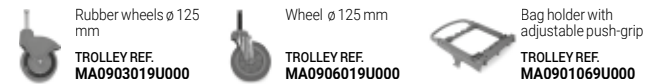

Rubber wheels ø 125 mm  
TROLLEY REF. **MA0903019U000**

Wheel ø 125 mm  
TROLLEY REF. **MA0906019U000**

Bag holder with adjustable push-grip  
TROLLEY REF. **MA0901069U000**



- PLASTIC BAG HOLDERS
- CHROME WASTE BAG HOLDER TROLLEYS
- PAPER HOLDERS
- BINS FOR LARGE AREAS
- BINS FOR SEPARATE WASTE COLLECTION
- SANITARY BINS

## Morgan trolleys

### MORGAN 1010 - plastic trolley



REF.	PCK	VOLUME (m³)	GROSS WEIGHT (kg)	SIZE (cm) ↓ ↓ ↓
<b>0000MP1010A</b>	1	0,191	12,96	93x57x104
0000SM00115U	FLIP - handle holder with rubber roll and snap closure fitting tubes Ø 22 mm			1 pc.
P202001A	Short plastic base with wheels ø 100 mm and bumpers for Morgan trolley			1 pc.
R1030010	Rilsan coated vertical frame complete with screws for Morgan trolley			1 pc.
R2060010	Rilsan coated bag holder 120 L with bag-stretchers for Morgan trolley			2 pc.

#### ACCESSORIES TO ORDER AS SEPARATE ITEMS

3639A	Blue plastic cover for bag holder 120 L art. 3657-R2060010-12060010 and R2060060	2 pc.
3650A	Blue plastified bag 73x97,5 cm, capacity 120 L	2 pc.

#### ON REQUEST, WITH SURCHARGE



### MORGAN 1030 - plastic trolley



REF.	PCK	VOLUME (m³)	GROSS WEIGHT (kg)	SIZE (cm) ↓ ↓ ↓
<b>0000MP1030U</b>	1	0,191	9,82	102x57x104
0000SM00115U	FLIP - handle holder with rubber roll and snap closure fitting tubes Ø 22 mm			1 pc.
P202001U	Short plastic base with wheels ø 100 mm and bumpers for Morgan trolley			1 pc.
P816010U	Plastic bag holder 120 L with push-bar, bag-stretchers and reinforcements			2 pc.
R1030147	Rilsan coated vertical frame with double connection for Morgan trolley art. 0000MP1030U			1 pc.

#### ACCESSORIES TO ORDER AS SEPARATE ITEMS

3650A	Blue plastified bag 73x97,5 cm, capacity 120 L	1 pc.
3650B	Red plastified bag 73x97,5 cm, capacity 120 L	1 pc.
P291918A	Blue cover for bag holder 120 L	1 pc.
P291918B	Red cover for bag holder 120 L	1 pc.

#### ON REQUEST, WITH SURCHARGE

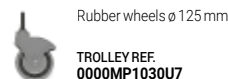



**PLASTIC BAG HOLDERS**

CHROME WASTE BAG HOLDER TROLLEYS

PAPER HOLDERS

BINS FOR LARGE AREAS

BINS FOR SEPARATE WASTE COLLECTION

SANITARY BINS

## Delta: high capacity and space-saving size in just one trolley

**Delta** plastic bag holding trolley has a rounded and smooth design and is easy to clean. It is equipped with a handy and ergonomic push-bar and a wide foot-operated pedal opening of the cover.

**Maximum flexibility:** available also in the version 2x60 L and 1x60L + 2x30 L for a much more efficient waste collection.

The bag holding trolley is now available in the **Delta Compact** version, ideal for the small and narrow spaces thanks to its space-saving size.

**Delta** and **Delta Compact** are available in grey and can be equipped with a multipurpose carry basket and useful hooks and handle holders.

### DELTA



### DELTA COMPACT



Version 2x60 L

Version 1x60 L + 2x30 L

Versions with 4 wheels

Versions with 2 wheels and 2 feet

## Delta bag holding trolleys

### DELTA - white plastic bag holding trolley 120 L complete with 4 wheels, pedal and coloured cover



REF.	NOTES	PCK	VOLUME (m³)	GROSS WEIGHT (kg)	SIZE (cm)
0000C04120D	with white cover	2	0,207	14,2	50x64x99
0000C04121D	with blue cover	2	0,207	14,2	50x64x99
0000C04122D	with red cover	2	0,207	14,2	50x64x99
0000C04123D	with yellow cover	2	0,207	14,2	50x64x99
0000C04124D	with green cover	2	0,207	14,2	50x64x99

With surcharge available in single package - To order the single bin, simply add the prefix 0001 on the front of the standard code. E.g. 0001C04120D

### DELTA - white plastic bag holding trolley 120 L complete with 2 wheels, 2 feet, pedal and coloured cover



REF.	NOTES	PCK	VOLUME (m³)	GROSS WEIGHT (kg)	SIZE (cm)
0000C04220D	with white cover	2	0,207	13,9	50x64x99
0000C04221D	with blue cover	2	0,207	13,9	50x64x99
0000C04222D	with red cover	2	0,207	13,9	50x64x99
0000C04223D	with yellow cover	2	0,207	13,9	50x64x99
0000C04224D	with green cover	2	0,207	13,9	50x64x99

With surcharge available in single package - To order the single bin, simply add the prefix 0001 on the front of the standard code. E.g. 0001C04220D



**PLASTIC BAG HOLDERS** | CHROME WASTE BAG HOLDER TROLLEYS | PAPER HOLDERS | BINS FOR LARGE AREAS | BINS FOR SEPARATE WASTE COLLECTION | SANITARY BINS

**DELTA** - white plastic bag holding trolley 120 L complete with 4 wheels, pedal and cover



REF.	NOTES	PCK	VOLUME (m³)	GROSS WEIGHT (kg)	SIZE (cm) ↓ ↓ ↓
<b>2000C04120D</b>	with 2x60 L bag holder	2	0,207	11,37	50x64x99
<b>3000C04120D</b>	with 1x60 L + 2x30 L bag holder	2	0,207	11,37	50x64x99



**DELTA** - white plastic bag holding trolley 120 L complete with 2 wheels, 2 feet, pedal and cover



REF.	NOTES	PCK	VOLUME (m³)	GROSS WEIGHT (kg)	SIZE (cm) ↓ ↓ ↓
<b>2000C04220D</b>	with 2x60 L bag holder	2	0,207	14,62	50x64x99
<b>3000C04220D</b>	with 1x60 L + 2x30 L bag holder	2	0,207	14,62	50x64x99



**DELTA COMPACT** - white plastic bag holder, with 2 wheels and 2 feet, pedal and coloured cover



REF.	NOTES	PCK	VOLUME (m³)	GROSS WEIGHT (kg)	SIZE (cm) ↓ ↓ ↓
<b>0003C04220D</b>		1	0,148	7,01	50x64x80



Ideal to be placed underneath worktops

## Delta bag holder

**DELTA** - white plastic bag holder for walls with fixing screws and wedges



REF.	NOTES	CAPACITY (L)	PCK	VOLUME (m³)	GROSS WEIGHT (kg)
<b>0000C04300D</b>		50	6	0,248	10,68



**PLASTIC BAG HOLDERS**

CHROME WASTE BAG HOLDER TROLLEYS

PAPER HOLDERS

BINS FOR LARGE AREAS

BINS FOR SEPARATE WASTE COLLECTION

SANITARY BINS

## Components and accessories for Delta bag holding trolleys

Plastic base with 2 wheels  $\phi$  125 mm for Delta trolley



REF.	NOTES
P290981D	for trolleys with 4 wheels
P290989D	for trolleys with wheels and feet

Aluminium rod (connecting pedal/cover) with plastic closing connections for Delta trolley



REF.	NOTES
P290977D	for Delta
P290979D	for Delta Compact





Plastic bag holder for Delta trolley



REF.	NOTES
P290978D	120 L
P390986D	2x60 L
P390987D	60 L + 2x30 L

Plastic cover for Delta bag holding trolley



REF.	NOTES
P290976A	
P290976B	
P290976C	
P290976D	
P290976F	



Please, require also no. 2 shock absorbing pistons art. P190908U for a perfect soft closing

Shock absorbing piston for a soft closing of the cover



REF.	NOTES
P190908U	





- PLASTIC BAG HOLDERS
- CHROME WASTE BAG HOLDER TROLLEYS
- PAPER HOLDERS
- BINS FOR LARGE AREAS
- BINS FOR SEPARATE WASTE COLLECTION
- SANITARY BINS

Set of two feet (right and left) for Delta trolley



REF.	NOTES
P190974D	

Plastic pedal for Delta trolley



REF.	NOTES
P190973D	

Pedal rod for Delta trolley



REF.	NOTES
P190972D	

Plastic carry basket for Delta bag holding trolley



REF.	NOTES
P190975N	



PLASTIC BAG HOLDERS

**CHROME WASTE BAG HOLDER TROLLEYS**

PAPER HOLDERS

BINS FOR LARGE AREAS

BINS FOR SEPARATE WASTE COLLECTION

SANITARY BINS

## "X" trolleys

Chromed X-trolley with square bag holder 120 L and pirouetting wheels ø 80 mm



REF.	NOTES	PCK	VOLUME (m³)	GROSS WEIGHT (kg)	SIZE (cm) ↓ ↓ ↓
<b>8042</b>		5	0,302	34,73	62x60x103

Chromed X-trolley with removable square bag holder 120 L and pirouetting wheels ø 80 mm



REF.	NOTES	PCK	VOLUME (m³)	GROSS WEIGHT (kg)	SIZE (cm) ↓ ↓ ↓
<b>8042/1</b>		2	0,16	13,93	62x60x103

**ROBBY** - painted X-trolley with round bag holder 120 L, elastic and pirouetting wheels ø 80 mm



REF.	NOTES	PCK	VOLUME (m³)	GROSS WEIGHT (kg)	SIZE (cm) ↓ ↓ ↓
<b>8045A</b>		5	0,302	33,23	58x56x102
<b>8045B</b>		5	0,302	33,23	58x56x102
<b>00018045A</b>		1	0,072	7,36	58x56x102
<b>00018045B</b>		1	0,072	7,36	58x56x102

Chromed X-trolley with round bag holder 120 L, elastic and pirouetting wheels ø 80 mm



REF.	NOTES	PCK	VOLUME (m³)	GROSS WEIGHT (kg)	SIZE (cm) ↓ ↓ ↓
<b>8070</b>		5	0,302	35,23	58x56x102
<b>00018070</b>		1	0,072	7,76	58x56x102



PLASTIC BAG HOLDERS

**CHROME WASTE BAG HOLDER TROLLEYS**

PAPER HOLDERS

BINS FOR LARGE AREAS

BINS FOR SEPARATE WASTE COLLECTION

SANITARY BINS

Chromed X-trolley with round bag holder 120 L, elastic, plastic cover, pedal set and pirouetting wheels ø 80 mm



REF.	NOTES	PCK	VOLUME (m³)	GROSS WEIGHT (kg)	SIZE (cm) ↓ ↓ ↓
<b>8075</b>		3	0,21	24,23	58x56x102
<b>00018075</b>		1	0,072	8,76	58x56x102

## Trolleys for outdoor use

Chromed bag holding trolley for outdoor use with round bag holder 120 L, elastic and wheels ø 185 mm



REF.	NOTES	PCK	VOLUME (m³)	GROSS WEIGHT (kg)	SIZE (cm) ↓ ↓ ↓
<b>8076</b>		2	0,177	12,7	58x58x102

It is possible to fix the chromed basket 50x20x13 cm art. 8205/2

Chromed bag holding trolley for outdoor use with round bag holder 120 L, elastic, wheels ø 185 mm, plastic cover and pedal



REF.	NOTES	PCK	VOLUME (m³)	GROSS WEIGHT (kg)	SIZE (cm) ↓ ↓ ↓
<b>8077</b>		2	0,177	14,36	52x58x102

Chromed bag holding trolley for outdoor use with round bag holder 70 L, elastic, wheels ø 185 mm, plastic cover and pedal



REF.	NOTES	CAPACITY (L)	PCK	VOLUME (m³)	GROSS WEIGHT (kg)	SIZE (cm) ↓ ↓ ↓
<b>8077/1</b>		150	2	0,177	12,7	48x58x102





PLASTIC BAG HOLDERS

**CHROME WASTE BAG HOLDER TROLLEYS**

PAPER HOLDERS

BINS FOR LARGE AREAS

BINS FOR SEPARATE WASTE COLLECTION

SANITARY BINS

Rilsan coated bag holding trolley for outdoor use with round bag holder 120 L, elastic, wheels  $\varnothing$  185 mm, plastic cover and pedal



REF.	NOTES	PCK	VOLUME (m <sup>3</sup> )	GROSS WEIGHT (kg)	SIZE (cm) ↓ ↓ ↓
<b>R8377</b>		2	0,244	13,93	57x52x91

Galvanized bag holding trolley complete with wheels  $\varnothing$  260 mm for street cleaning



REF.	NOTES	PCK	VOLUME (m <sup>3</sup> )	GROSS WEIGHT (kg)	SIZE (cm) ↓ ↓ ↓
<b>8050</b>		1	0,567	15,11	77x68x114



It is used with bin 120 L art. 0000C01120F - It can be equipped with plastic bin 25 L art. 8169/1

Galvanized bag holding trolley with bag holder 120 L and wheels  $\varnothing$  260 mm for street cleaning



REF.	NOTES	PCK	VOLUME (m <sup>3</sup> )	GROSS WEIGHT (kg)	SIZE (cm) ↓ ↓ ↓
<b>8040</b>		1	0,567	18,41	77x68x114



It can be equipped with plastic bin 25 L art. 8169/1

Galvanized bag holding trolley complete with wheels  $\varnothing$  260 mm for street cleaning



REF.	NOTES	PCK	VOLUME (m <sup>3</sup> )	GROSS WEIGHT (kg)	SIZE (cm) ↓ ↓ ↓
<b>8450</b>		1	0,567	15,11	77x68x114



It can be equipped with a 25 L bin art. 8169/1 - It can be used with plastic bin 120 L art. 0000C01120F



PLASTIC BAG HOLDERS

**CHROME WASTE BAG HOLDER TROLLEYS**

PAPER HOLDERS

BINS FOR LARGE AREAS

BINS FOR SEPARATE WASTE COLLECTION

SANITARY BINS

Galvanized bag holding trolley complete with bag holder 120 L and wheels ø 260 mm for street cleaning



REF.	NOTES	PCK	VOLUME (m <sup>3</sup> )	GROSS WEIGHT (kg)	SIZE (cm) ↓ ↓ ↓
8440		1	0,567	18,41	77x68x114

It can be equipped with plastic bin 25 L art. 8169/1

**TREND** - free standing bag holder 70 L with elastic and yellow plastic cover



REF.	NOTES	PCK	VOLUME (m <sup>3</sup> )	GROSS WEIGHT (kg)
8174C	height 72 cm	5	0,246	14,4

**TREND** - free standing bag holder 70 L with elastic, yellow plastic cover, wheels ø 35 mm and bag support



REF.	NOTES	PCK	VOLUME (m <sup>3</sup> )	GROSS WEIGHT (kg)
8175	height 76 cm	5	0,246	17,9

Green bag holder for outdoor use, without cover



REF.	NOTES	PCK	VOLUME (m <sup>3</sup> )	GROSS WEIGHT (kg)
8191F	height 99 cm	2	0,2	14,39



PLASTIC BAG HOLDERS

**CHROME WASTE BAG HOLDER TROLLEYS**

PAPER HOLDERS

BINS FOR LARGE AREAS

BINS FOR SEPARATE WASTE COLLECTION

SANITARY BINS

## Multi-sort waste separation trolleys

Chromed trolley tube  $\varnothing$  25 cm with double bag holder 2x120 L and pirouetting wheels  $\varnothing$  100 mm



REF.	NOTES	PCK	VOLUME (m <sup>3</sup> )	GROSS WEIGHT (kg)	SIZE (cm) ↓ ↓ ↓
<b>8049</b>		2	0,302	17,35	67x60x110

### TEDDY 8083 - chromed trolley



REF.	PCK	VOLUME (m <sup>3</sup> )	GROSS WEIGHT (kg)	SIZE (cm) ↓ ↓ ↓
<b>8083X</b>	1	0,191	10,48	82x51x105
0000SM00115U	FLIP - handle holder with rubber roll and snap closure fitting tubes $\varnothing$ 22 mm			1 pc.
3657	Chromed bag holder 120 L for Teddy trolleys			2 pc.
8203/2	Chromed vertical frame for Teddy trolleys			1 pc.
8611U	Plastic flanges with screws for vertical frame fixing			2 pc.
C8201CL	Chromed base 47x80 cm with wheels $\varnothing$ 100 mm and bumpers for trolleys art. 8080X and 8083X			1 pc.

#### ACCESSORIES TO ORDER AS SEPARATE ITEMS

3639A	Blue plastic cover for bag holder 120 L art. 3657-R2060010- I2060010 and R2060060			1 pc.
3639B	Red plastic cover for bag holder 120 L art. 3657-R2060010- I2060010 and R2060060			1 pc.
3650A	Blue plastified bag 73x97,5 cm, capacity 120 L			1 pc.
3650B	Red plastified bag 73x97,5 cm, capacity 120 L			1 pc.
8227	Plastic tray for the base of the trolleys art. 8049, Teddy 8090X-8098X and Panda			1 pc.

### TEDDY R8083 - Rilsan coated trolley

REF.	PCK	VOLUME (m <sup>3</sup> )	GROSS WEIGHT (kg)	SIZE (cm) ↓ ↓ ↓
<b>R8083X</b>	1	0,191	10,48	82x51x105

Available while stocks last

### ECOLOGY 3100 - chromed trolley



REF.	PCK	VOLUME (m <sup>3</sup> )	GROSS WEIGHT (kg)	SIZE (cm) ↓ ↓ ↓
<b>3100</b>	1	0,291	27,62	84x58x110
3604	Chromed vertical frame for Jumbo trolley			2 pc.
3647	Chromed basket holder for Ecology trolleys			1 pc.
3667A	PICK-UP - blue plastic bin 45 L without wheels, complete with cover and screen printed plastic plate with image "paper"			1 pc.
3667B	PICK-UP - red plastic bin 45 L without wheels, complete with cover and screen printed plastic plate with image "metal"			1 pc.
3667C	PICK-UP - yellow plastic bin 45 L without wheels, complete with cover and screen printed plastic plate with image "plastic"			1 pc.
3667F	PICK-UP - green plastic bin 45 L without wheels, complete with cover and screen printed plastic plate with image "glass"			1 pc.
C3629CL	Chromed base 77x51 cm with wheels $\varnothing$ 100 mm and bumpers for Jumbo Tank, Master and Quick trolleys			1 pc.



PLASTIC BAG HOLDERS

**CHROME WASTE BAG HOLDER TROLLEYS**

PAPER HOLDERS

BINS FOR LARGE AREAS

BINS FOR SEPARATE WASTE COLLECTION

SANITARY BINS

## Components and accessories for chromed bag holders

Round plastic cover with hinges fitting trolleys art. 8045, 8070, 8075, 8076, 8077, 8077/1, R8377, 8040 and 8440



REF.	NOTES
8055B	



Square plastic cover with hinges fitting "X" trolley art. 8042



REF.	NOTES
8056DB	

Round plastic cover with hinges fitting bag holding trolley Trend



REF.	NOTES
8400A	
8400B	
8400C	

Round cover for bag holder for outdoor use complete with screws



REF.	NOTES
8092F	

Plastic coated basket for trolleys art. 8042, 8042/1, 8045, 8070 and 8075



REF.	NOTES	SIZE (cm)
8053		↓ ↓ ↓ 41,5x22,5x21

Chromed basket for Teddy and art. 8076 trolleys



REF.	NOTES	SIZE (cm)
8205/2		↓ ↓ ↓ 50x20x13

For the Teddy and Ecology trolley components and accessories see the multipurpose trolley range



PLASTIC BAG HOLDERS

**CHROME WASTE BAG  
HOLDER TROLLEYS**

PAPER HOLDERS

BINS FOR LARGE AREAS

BINS FOR SEPARATE  
WASTE COLLECTION

SANITARY BINS

Chromed frame for basket art. 8205 for "X" trolleys art. 8042, 8042/1, 8045 and 8070



REF.	NOTES
8071	

Chromed basket fitting vertical frame art. 8071



REF.	NOTES	SIZE (cm) ↓↓↓
8205		43,5x26x16

Bag fixing elastic



REF.	NOTES
8054	for trolleys art.8045, 8070, 8075, 8076, 8077, 8077/1 and R8377
8054/1	for Trend and laundry trolleys

Pedal set with rods



REF.	NOTES
8074	for Robby trolley art. 8075
8079	for free standing trolleys art. 8076 and 8077
8079/1	for free standing trolley art. 8077/1

Plastic tray for the base of the trolleys art. 8049, Teddy 8090X-8098X and Panda



REF.	NOTES	SIZE (cm) ↓↓↓
8227		39,5x59x2,5

Chromed paper holder for trolleys art. 8045, 8070, 8042 and 8042/1



REF.	NOTES
8072	

For the Teddy and Ecology trolley components and accessories see the multipurpose trolley range



PLASTIC BAG HOLDERS

**CHROME WASTE BAG HOLDER TROLLEYS**

PAPER HOLDERS

BINS FOR LARGE AREAS

BINS FOR SEPARATE WASTE COLLECTION

SANITARY BINS

Galvanized bag holder 120 L with elastic for street cleaning's trolley



REF.	NOTES
Z2060104	

Plastified side panel with pockets fitting trolleys art. 8042, 8042/1, 8045, 8070, 8075 and 8043



REF.	NOTES	SIZE (cm) ↓ ↓ ↓
8058		74x48

Ash-tray box for trolleys art. 8042/1



REF.	NOTES
8073B	

Plastic clip for bag fixing



REF.	NOTES
8220/1	

Plastic bag fixing clip



REF.	NOTES
8220A	

For the Teddy and Ecology trolley components and accessories see the multipurpose trolley range



PLASTIC BAG HOLDERS

CHROME WASTE BAG  
HOLDER TROLLEYS

**PAPER HOLDERS**

BINS FOR LARGE AREAS

BINS FOR SEPARATE  
WASTE COLLECTION

SANITARY BINS

## Painted metal paper holders

### Painted white metal wall paper holder



REF.	NOTES	PCK	VOLUME (m <sup>3</sup> )	GROSS WEIGHT (kg)	SIZE (cm) ↓ ↓ ↓
<b>8171</b>		10	0,115	19,13	22x40x35,5

### Painted white metal standing paper holder on wheels



REF.	NOTES	PCK	VOLUME (m <sup>3</sup> )	GROSS WEIGHT (kg)	SIZE (cm) ↓ ↓ ↓
<b>8172</b>		5	0,19	18,56	49x62x103

## Plastic paper holders

### Plastic wall paper holder



REF.	NOTES	PCK	VOLUME (m <sup>3</sup> )	GROSS WEIGHT (kg)	SIZE (cm) ↓ ↓ ↓
<b>8271</b>		3	0,09	3,3	44x31x40

### Closed plastic standing paper holder on wheels



REF.	NOTES	PCK	VOLUME (m <sup>3</sup> )	GROSS WEIGHT (kg)	SIZE (cm) ↓ ↓ ↓
<b>8272</b>		4	0,153	9,06	51,5x47x91



PLASTIC BAG HOLDERS

CHROME WASTE BAG  
HOLDER TROLLEYS

**PAPER HOLDERS**

BINS FOR LARGE AREAS

BINS FOR SEPARATE  
WASTE COLLECTION

SANITARY BINS

## Closed paper holders

### Closed plastic wall paper holder



REF.	NOTES	PCK	VOLUME (m <sup>3</sup> )	GROSS WEIGHT (kg)	SIZE (cm) ↓ ↓ ↓
<b>8571</b>		1	0,048	2	36x31,5x34

### Plastic standing paper holder on wheels



REF.	NOTES	PCK	VOLUME (m <sup>3</sup> )	GROSS WEIGHT (kg)	SIZE (cm) ↓ ↓ ↓
<b>8472</b>		1	0,186	3,5	51,5x47x91

## Paper holders

### Painted bag holder 120 L complete with basket (39x12x10 cm), clip with spring and wheels ø 175 mm



REF.	NOTES	PCK	VOLUME (m <sup>3</sup> )	GROSS WEIGHT (kg)	SIZE (cm) ↓ ↓ ↓
<b>8167</b>		2	0,244	12,87	44x45x95





PLASTIC BAG HOLDERS

CHROME WASTE BAG HOLDER TROLLEYS

PAPER HOLDERS

**BINS FOR LARGE AREAS**

BINS FOR SEPARATE WASTE COLLECTION

SANITARY BINS

# HANDY®

S I S T E M



## A "GREENER" trash collection

Bins for aneco friendly waste collection system

- **ERGONOMIC:** with push-grip, side grips and back wheels to transport it easily
- **VERSATILE:** it can be used with or without bag as a single container or combined with our multipurpose Alpha trolleys for a practical and efficient waste collection
- **ECO-FRIENDLY:** there is no need of a garbage bag to make waste collection, with clear advantages in terms of cost reduction and lower environmental impact due to the disposal of polybags
- **HYGIENIC:** optimum inside and outside cleaning of the bin thanks to its smooth surfaces and its drain plug
- **COMPACT:** the opening of the lid up to 270° and the foldable push-bar guarantee the minimum space (71 cm) in order to use Handy bins in different contexts, for example under the worktables of kitchens



WASTE COLLECTION

## Handy bins

**HANDY** - bin 70 L with drain plug, wheels, bag stretcher, grip and cover



REF.	NOTES	PCK	VOLUME (m <sup>3</sup> )	GROSS WEIGHT (kg)	SIZE (cm) ↓ ↓ ↓
0000C06170E		2	0,293	12,8	51,5x56x86





PLASTIC BAG HOLDERS

CHROME WASTE BAG HOLDER TROLLEYS

PAPER HOLDERS

**BINS FOR LARGE AREAS**

BINS FOR SEPARATE WASTE COLLECTION

SANITARY BINS

**HANDY** - bin 70 L with drain plug, wheels, bag stretcher and grip



REF.	NOTES	PCK	VOLUME (m³)	GROSS WEIGHT (kg)	SIZE (cm) ↓ ↓ ↓
P391070E		2	0,293	11,41	51,5x56x86

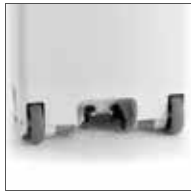

**HANDY** - bin 70 L with drain plug, wheels and bag stretcher



REF.	NOTES	PCK	VOLUME (m³)	GROSS WEIGHT (kg)	SIZE (cm) ↓ ↓ ↓
P291070E		2	0,293	10,6	37x56x71



WASTE COLLECTION

## Components and accessories for Handy bin

Cover set complete with rubber lace, cage for deodorant pills and screws

REF.	NOTES
P290068E	



Assembling kit to fix Handy bin to Alpha vertical frame

REF.	NOTES
0000SM00610	





PLASTIC BAG HOLDERS

CHROME WASTE BAG HOLDER TROLLEYS

PAPER HOLDERS

**BINS FOR LARGE AREAS**

BINS FOR SEPARATE WASTE COLLECTION

SANITARY BINS



**Oyster** is the first wall mounted bin with foot pedal opening. It is really a unique and exclusive model, with a modern and elegant design. It is very easy to clean thanks to its smooth and round surface.

It has a wide opening (50 L capacity) and a very simple and safe wall fixing system.

User-friendly and suitable for any environment, Oyster is made **in compliance with HACCP** rules: therefore, it is advised for food industry, restaurants, canteens and all the environments associated with food processing activities.



The bin is wall mounted in order to make the cleaning operations easier; furthermore, it is equipped with a key locking system device which guarantees, on one hand the fixing of the bin to its support, avoiding its accidental falling down and on the other hand the release of the bin for the emptying and cleaning operations.

## Oyster bins

**OYSTER** - wall mounted plastic bin 50 L with pedal and cover



REF.	NOTES		CAPACITY (L)	PCK	VOLUME (m <sup>3</sup> )	GROSS WEIGHT (kg)	SIZE (cm) ↓ ↓ ↓
0000C05050D	with all the components in white colour		50	1	0,123	5,45	39x53,5x81
0000C05050U	with all the components in grey colour		50	1	0,123	5,45	39x53,5x81
0000C05050DUD	white, with grey pedal		50	1	0,123	5,45	39x53,5x81
0000C05050DUA	white, with grey pedal and blue cover		50	1	0,123	5,45	39x53,5x81
0000C05050DUB	white, with grey pedal and red cover		50	1	0,123	5,45	39x53,5x81
0000C05050DUC	white, with grey pedal and yellow cover		50	1	0,123	5,45	39x53,5x81
0000C05050DUF	white, with grey pedal and green cover		50	1	0,123	5,45	39x53,5x81
0000C05050DUU	white, with grey pedal and grey cover		50	1	0,123	5,45	39x53,5x81





PLASTIC BAG HOLDERS

CHROME WASTE BAG HOLDER TROLLEYS

PAPER HOLDERS

**BINS FOR LARGE AREAS**

BINS FOR SEPARATE WASTE COLLECTION

SANITARY BINS

**OYSTER** - wall mounted plastic bin 50 L without pedal and without cover



REF.	NOTES	PCK	VOLUME (m <sup>3</sup> )	GROSS WEIGHT (kg)
0000C05150D		1	0,123	4,6
0000C05150U		1	0,123	4,6

## Components and accessories for Oyster bin

Plastic cover for Oyster bin



REF.	NOTES
P190060A	
P190060B	
P190060C	
P190060D	
P190060F	
P190060U	



Plastic bag stretcher for Oyster bin



REF.	NOTES
SLP015000001D	
SLP015000001U	

Plastic key for Oyster bin



REF.	NOTES
SLP015000009H	

Shock absorbing piston for a soft closing of the cover



REF.	NOTES
P190908U	





PLASTIC BAG HOLDERS

CHROME WASTE BAG  
HOLDER TROLLEYS

PAPER HOLDERS

**BINS FOR LARGE AREAS**

BINS FOR SEPARATE  
WASTE COLLECTION

SANITARY BINS

## Plastic pedal for Oyster bin



REF.	NOTES
SLP01500004D	<input type="checkbox"/>
SLP01500004U	<input checked="" type="checkbox"/>

## Plastic rod for wall mounting Oyster bin



REF.	NOTES
P190061H	

## Plastic pedal rod for Oyster bin



REF.	NOTES
SLP01500007H	

## Painted display stand support complete with screws for Oyster bin



REF.	NOTES	PCK	VOLUME (m <sup>3</sup> )	GROSS WEIGHT (kg)
V190062		3	0,21	27,19

## Double-sided tape set for Oyster wall mounting

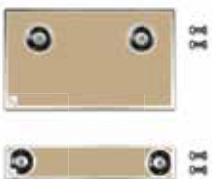

REF.	NOTES
0000SM00600	



PLASTIC BAG HOLDERS

CHROME WASTE BAG HOLDER TROLLEYS

PAPER HOLDERS

**BINS FOR LARGE AREAS**

BINS FOR SEPARATE WASTE COLLECTION

SANITARY BINS

The **Polaris Delux** bin 90 L is handy and can be placed everywhere; it is made **in compliance with the HACCP rules**: therefore, it is the ideal bin for kitchens, restaurants, canteens and all the environments associated with food processing activities. It is completely made of polypropylene, strong and round-shaped for an easy cleaning. It can be equipped with shock absorbing pistons "Hush System" for a soft closing of the cover and with several accessories, such as a multipurpose plastic basket, a paper-roll holder and several different hooks to carry small cleaning tools.



The door has a 250° opening that allows to take out and empty the bag in a practical way reducing the operator's efforts.



It is equipped with an ergonomic push-bar and plastic wheels Ø 125 mm to handle the bin better and easier.



The cover has a 90° opening that helps the operator while emptying the bin.



It is equipped with two plastic hooks to fix the bag and one cage for deodorant or disinfectant pills.

## Polaris Delux bins

**POLARIS DELUX** - beige plastic bin 90 L with front door, pedal, push-bar, wheels Ø 125 mm and coloured cover



REF.	NOTES	PCK	VOLUME (m³)	GROSS WEIGHT (kg)	SIZE (cm)
0000C03090I	with beige cover	2	0,223	18,79	53x50x93
0000C03091I	with blue cover	2	0,223	18,79	53x50x93
0000C03092I	with red cover	2	0,223	18,79	53x50x93
0000C03093I	with yellow cover	2	0,223	18,79	53x50x93
0000C03094I	with green cover	2	0,223	18,79	53x50x93

With surcharge available in single package - To order it single packed, just add 0001 before the letters in the standard reference. Ex: 0001C03090I - Advised bag size: 72x100 cm or 82x100 cm

**POLARIS DELUX** - green plastic bin 90 L with front door, pedal, push-bar, wheels Ø 125 mm and cover



REF.	NOTES	PCK	VOLUME (m³)	GROSS WEIGHT (kg)	SIZE (cm)
0000C03090F		2	0,223	18,79	53x50x93

With surcharge available in single package - To order this bin single packed, just add 0001 before the letters in the standard reference. Ex 0001C03090F - Advised bag size: 72x100 cm or 82x100 cm



PLASTIC BAG HOLDERS

CHROME WASTE BAG  
HOLDER TROLLEYS

PAPER HOLDERS

**BINS FOR LARGE AREAS**

BINS FOR SEPARATE  
WASTE COLLECTION

SANITARY BINS

**POLARIS DELUX** - beige plastic bin 90 L with bag holder 2x45 L, front door, pedal, push-bar, wheels Ø 125 mm and coloured cover



REF.	NOTES	PCK	VOLUME (m³)	GROSS WEIGHT (kg)	SIZE (cm) ↓ ↓ ↓
0000C03190I	with beige cover	2	0,223	18,79	53x50x93
0000C03191I	with blue cover	2	0,223	18,79	53x50x93
0000C03192I	with red cover	2	0,223	18,79	53x50x93
0000C03193I	with yellow cover	2	0,223	18,79	53x50x93
0000C03194I	with green cover	2	0,223	18,79	53x50x93

With surcharge available in single package - To order it single packed, just add 0001 before the letters in the standard reference. Ex: 0001C03190I

**POLARIS DELUX** - green plastic bin 90 L with bag holder 2x45 L, front door, pedal, push-bar, wheels Ø 125 mm and cover



REF.	NOTES	PCK	VOLUME (m³)	GROSS WEIGHT (kg)	SIZE (cm) ↓ ↓ ↓
0000C03190F		2	0,223	18,79	53x50x93

With surcharge available in single package - To order this bin single packed, just add 0001 before the letters in the standard reference. Ex: 0001C03190F

## ■ Polaris bins

**POLARIS** - beige plastic bin 90 L with pedal, push-bar, wheels Ø 100 mm and coloured cover



REF.	NOTES	PCK	VOLUME (m³)	GROSS WEIGHT (kg)	SIZE (cm) ↓ ↓ ↓
0000C02090I	with beige cover	2	0,216	15,06	51x47x93
0000C02091I	with blue cover	2	0,216	15,06	51x47x93
0000C02092I	with red cover	2	0,216	15,06	51x47x93
0000C02093I	with yellow cover	2	0,216	15,06	51x47x93
0000C02094I	with green cover	2	0,216	15,06	51x47x93



With surcharge available in single package - To order it single packed, just add 0001 before the letters in the standard reference. Ex: 0001C02090I - Advised bag size: 72x100 cm or 82x100 cm



PLASTIC BAG HOLDERS

CHROME WASTE BAG  
HOLDER TROLLEYS

PAPER HOLDERS

**BINS FOR LARGE AREAS**

BINS FOR SEPARATE  
WASTE COLLECTION

SANITARY BINS

**POLARIS** - beige plastic bin 90 L with bag holder 2x45 L, pedal, push-bar, wheels ø 100 mm and coloured cover



REF.	NOTES	PCK	VOLUME (m³)	GROSS WEIGHT (kg)	SIZE (cm)
0000C02190I	with beige cover	2	0,216	15,56	51x47x93
0000C02191I	with blue cover	2	0,216	15,56	51x47x93
0000C02192I	with red cover	2	0,216	15,56	51x47x93
0000C02193I	with yellow cover	2	0,216	15,56	51x47x93
0000C02194I	with green cover	2	0,216	15,56	51x47x93



With surcharge available in single package - To order this bin single packed, just add 0001 before the letters in the standard reference. Ex 0001C02190I

## Components and accessories for Polaris and Polaris Deluxe

Beige Polaris plastic bin 90 L without cover, with pedal, push-grip and wheels Ø 100 mm



REF.	NOTES	PCK	VOLUME (m³)	GROSS WEIGHT (kg)
P190915I		2	0,216	13,48



Plastic cover for Polaris Deluxe 90 L



REF.	NOTES	PCK	VOLUME (m³)	GROSS WEIGHT (kg)
P290914A		20	0,258	19,9
P290914B		20	0,258	19,9
P290914C		20	0,258	19,9
P290914F		20	0,258	19,9
P290914I		20	0,258	19,9

Please, require also no. 2 shock absorbing pistons art. P190908U for a perfect soft closing

Plastic cover for Polaris 90 L



REF.	NOTES	PCK	VOLUME (m³)	GROSS WEIGHT (kg)
P190914A		20	0,258	19,74
P190914B		20	0,258	19,74
P190914C		20	0,258	19,74
P190914F		20	0,258	19,74
P190914I		20	0,258	19,74

Please, require also no. 2 shock absorbing pistons art. P190908U for a perfect soft closing





PLASTIC BAG HOLDERS

CHROME WASTE BAG  
HOLDER TROLLEYS

PAPER HOLDERS

**BINS FOR LARGE AREAS**

BINS FOR SEPARATE  
WASTE COLLECTION

SANITARY BINS

## Plastic cover for Polaris and Polaris Delux 2x45 L



REF.	NOTES
P390914A	
P390914B	
P390914C	
P390914F	
P390914I	



Please, require also no. 2 shock absorbing pistons art. P190908U for a perfect soft closing

## Shock absorbing piston for a soft closing of the cover



REF.	NOTES
P190908U	



## Sticky label 11x11,5 cm with image for separate waste collection



REF.	NOTES
701421	with image "metal"
701422	with image "paper"
701424	with image "organic waste"
701425	with image "plastic"
701426	with image "glass"
701428	with image "non-recyclable waste"

## Sticky label 11x11,5 cm with image and writing for separate waste collection



REF.	NOTES
701431	with image and writing "metalli"
701432	with image and writing "carta"
701434	with image and writing "umido"
701435	with image and writing "plastica"
701436	with image and writing "vetro"
701438	with image and writing "secco"

## EXOGERM - Dichlorisocianurate tabs with disinfecting properties, for bins



REF.	NOTES
0000SM01340	10 tabs per small plastic bottle

## Plastic handle holder for Polaris and Polaris Delux bins



REF.	NOTES
0000SM01311	

## Plastic hook for Polaris and Polaris Delux bins



REF.	NOTES
0000SM01321	



PLASTIC BAG HOLDERS

CHROME WASTE BAG HOLDER TROLLEYS

PAPER HOLDERS

**BINS FOR LARGE AREAS**

BINS FOR SEPARATE WASTE COLLECTION

SANITARY BINS

**FLIP** - handle holder with rubber roll for Polaris and Polaris Delux bins



REF.	NOTES
0000SM00111	



Plastic side basket set for Polaris and Polaris Delux bins



REF.	NOTES
0000SM01331	

Set of paper holder with cover and 3 hooks for Polaris and Polaris Delux bins



REF.	NOTES
P2250061	

WASTE COLLECTION

## Plastic bins 120 L

Polyethylene bin 120 L with cover, bag stretcher and axial wheels ø 200 mm



REF.	NOTES	PCK	VOLUME (m³)	GROSS WEIGHT (kg)	SIZE (cm) ↓ ↓ ↓
0000C01120D		1	0,291	13,62	48x55x93
0000C01120F		1	0,291	13,62	48x55x93

Polyethylene bin 120 L with cover, bag stretcher, pedal and axial wheels ø 200 mm



REF.	NOTES	PCK	VOLUME (m³)	GROSS WEIGHT (kg)	SIZE (cm) ↓ ↓ ↓
0000C02120D		1	0,291	15,62	48x55x93
0000C02120F		1	0,291	15,43	48x55x93



PLASTIC BAG HOLDERS

CHROME WASTE BAG HOLDER TROLLEYS

PAPER HOLDERS

BINS FOR LARGE AREAS

**BINS FOR SEPARATE WASTE COLLECTION**

SANITARY BINS

## Sirius waste collection bins:

- **Eco-friendly:** certified "Plastic Second Life", that is to say made of recycled plastic materials, according to the **Green Public Procurements** environmental policies
- **Versatile:** available in 60L, 30L, 2x30L and 2x15L; and from now on available also the new versions 30L+2x15L and 15L+2x8L for a much more efficient waste collection
- **Hygienic:** thanks to their round-shaped line
- **Ergonomic:** foot pedal opening cover; built-in pedal to avoid bin upsetting and reduce the overall dimensions of the bin
- **In compliance with HACCP rules:** it is the ideal bin for kitchens, restaurants, canteens and all the environments associated with food processing activities



## Sirius bins

### SIRIUS - plastic white bin with pedal, bag stretcher and coloured cover

REF.	NOTES	CAPACITY (L)	PCK	VOLUME (m <sup>3</sup> )	GROSS WEIGHT (kg)	SIZE (cm) ↓ ↓ ↓
0000C03030D	with white cover	30 L	3	0,148	8,94	51x37x47
0000C03031D	with blue cover	30 L	3	0,148	8,94	51x37x47
0000C03032D	with red cover	30 L	3	0,148	8,94	51x37x47
0000C03033D	with yellow cover	30 L	3	0,148	8,94	51x37x47
0000C03034D	with green cover	30 L	3	0,148	8,94	51x37x47
0000C03060D	with white cover	60 L	3	0,173	12,01	51x37x67
0000C03061D	with blue cover	60 L	3	0,173	12,01	51x37x67
0000C03062D	with red cover	60 L	3	0,173	12,01	51x37x67
0000C03063D	with yellow cover	60 L	3	0,173	12,01	51x37x67
0000C03064D	with green cover	60 L	3	0,173	12,01	51x37x67



### SIRIUS - plastic white bin with divider, pedal, bag stretcher and coloured cover

REF.	NOTES	CAPACITY (L)	PCK	VOLUME (m <sup>3</sup> )	GROSS WEIGHT (kg)	SIZE (cm) ↓ ↓ ↓
0000C03130D	with white cover	2x15 lt	3	0,148	9,21	51x37x47
0000C03131D	with blue cover	2x15 lt	3	0,148	9,21	51x37x47
0000C03132D	with red cover	2x15 lt	3	0,148	9,21	51x37x47
0000C03133D	with yellow cover	2x15 lt	3	0,148	9,21	51x37x47
0000C03134D	with green cover	2x15 lt	3	0,148	9,21	51x37x47
0000C03160D	with white cover	2x30 L	3	0,173	12,53	51x37x67
0000C03161D	with blue cover	2x30 L	3	0,173	12,29	51x37x67
0000C03162D	with red cover	2x30 L	3	0,173	12,29	51x37x67
0000C03163D	with yellow cover	2x30 L	3	0,173	12,29	51x37x67
0000C03164D	with green cover	2x30 L	3	0,173	12,29	51x37x67





PLASTIC BAG HOLDERS

CHROME WASTE BAG HOLDER TROLLEYS

PAPER HOLDERS

BINS FOR LARGE AREAS

**BINS FOR SEPARATE WASTE COLLECTION**

SANITARY BINS

**SIRIUS** - plastic white bin with triple divider, pedal, bag stretcher and coloured cover

REF.	NOTES	CAPACITY (L)	PCK	VOLUME (m³)	GROSS WEIGHT (kg)	SIZE (cm)
0000C03230D	with white cover	15 L + 2x8 L	3	0,148	9,46	51x37x47
0000C03231D	with blue cover	15 L + 2x8 L	3	0,148	9,46	51x37x47
0000C03232D	with red cover	15 L + 2x8 L	3	0,148	9,46	51x37x47
0000C03233D	with yellow cover	15 L + 2x8 L	3	0,148	9,46	51x37x47
0000C03234D	with green cover	15 L + 2x8 L	3	0,148	9,46	51x37x47
0000C03260D	with white cover	30 L + 2x15 L	3	0,173	12,53	51x37x67
0000C03261D	with blue cover	30 L + 2x15 L	3	0,173	12,53	51x37x67
0000C03262D	with red cover	30 L + 2x15 L	3	0,173	12,53	51x37x67
0000C03263D	with yellow cover	30 L + 2x15 L	3	0,173	12,53	51x37x67
0000C03264D	with green cover	30 L + 2x15 L	3	0,173	12,53	51x37x67



## Components and accessories for Sirius bin

Plastic cover for Sirius bins 30 L and 60 L with bag stretcher, cage for deodorant pills and pins



REF.	NOTES
P290934A	
P290934B	
P290934C	
P290934D	
P290934F	

Plastic divider for Sirius bins 30 L and 60 L



REF.	NOTES
P190926D	for versions 2x15 L and 2x30 L



PLASTIC BAG HOLDERS

CHROME WASTE BAG  
HOLDER TROLLEYS

PAPER HOLDERS

BINS FOR LARGE AREAS

**BINS FOR SEPARATE  
WASTE COLLECTION**

SANITARY BINS

## Sticky label 11x11,5 cm with image for separate waste collection



REF.	NOTES
701421	with image "metal"
701422	with image "paper"
701424	with image "organic waste"
701425	with image "plastic"
701426	with image "glass"
701428	with image "non-recyclable waste"

## Sticky label 11x11,5 cm with image and writing for separate waste collection



REF.	NOTES
701431	with image and writing "metalli"
701432	with image and writing "carta"
701434	with image and writing "umido"
701435	with image and writing "plastica"
701436	with image and writing "vetro"
701438	with image and writing "secco"



PLASTIC BAG HOLDERS

CHROME WASTE BAG HOLDER TROLLEYS

PAPER HOLDERS

BINS FOR LARGE AREAS

**BINS FOR SEPARATE WASTE COLLECTION**

SANITARY BINS

For separate collection in environments such as offices, canteens and dining rooms, Filmop offers their **Patty bins linked up**: thanks to colour-coded lids and the **new removable linking system device**, which allows to combine either 25 L bins or 50 L bins together, it is possible to have an efficient waste collection area.



Today Patty bins 25 L and 50 L are available in the new version **complete with bag stretchers** to better support the waste bag.



WASTE COLLECTION

## Patty bins

**PATTY** - plastic white bin with coloured swing lid

REF.	NOTES	CAPACITY (L)	PCK	VOLUME (m <sup>3</sup> )	GROSS WEIGHT (kg)	SIZE (cm)
8369	with white swing cover	25	4	0,095	6,27	30x25x52
8369A	with blue swing cover	25	4	0,095	6,27	30x25x52
8369B	with red swing cover	25	4	0,095	6,27	30x25x52
8369C	with yellow swing cover	25	4	0,095	6,27	30x25x52
8369E	with grey swing cover	25	4	0,095	6,27	30x25x52
8369F	with green swing cover	25	4	0,095	6,27	30x25x52
8369G	with brown swing cover	25	4	0,095	6,27	30x25x52
8370	with white swing cover	50	4	0,15	8,56	36x29x65
8370A	with blue swing cover	50	4	0,15	8,56	36x29x65
8370B	with red swing cover	50	4	0,15	8,56	36x29x65
8370C	with yellow swing cover	50	4	0,15	8,56	36x29x65
8370E	with grey swing cover	50	4	0,15	8,56	36x29x65
8370F	with green swing cover	50	4	0,15	8,56	36x29x65
8370G	with brown swing cover	50	4	0,15	8,56	36x29x65





PLASTIC BAG HOLDERS

CHROME WASTE BAG HOLDER TROLLEYS

PAPER HOLDERS

BINS FOR LARGE AREAS

**BINS FOR SEPARATE WASTE COLLECTION**

SANITARY BINS

**PATTY** - plastic white bin with coloured swing lid



REF.	NOTES	CAPACITY (L)	PCK	VOLUME (m <sup>3</sup> )	GROSS WEIGHT (kg)	SIZE (cm) ↓ ↓ ↓
8162	with white swing cover	12	4	0,041	2,76	23x20x40
8162A	with blue swing cover	12	4	0,041	2,76	23x20x40
8162B	with red swing cover	12	4	0,041	2,76	23x20x40
8162C	with yellow swing cover	12	4	0,041	2,76	23x20x40
8162E	with grey swing cover	12	4	0,041	2,76	23x20x40
8162F	with green swing cover	12	4	0,041	2,76	23x20x40
8162G	with brown swing cover	12	4	0,041	2,76	23x20x40
8169	with white swing cover	25	4	0,095	5,6	30x25x52
8169A	with blue swing cover	25	4	0,095	5,6	30x25x52
8169B	with red swing cover	25	4	0,095	5,6	30x25x52
8169C	with yellow swing cover	25	4	0,095	5,6	30x25x52
8169E	with grey swing cover	25	4	0,095	5,6	30x25x52
8169F	with green swing cover	25	4	0,095	5,6	30x25x52
8169G	with brown swing cover	25	4	0,095	5,6	30x25x52
8170	with white swing cover	50	4	0,15	8,28	36x29x65
8170A	with blue swing cover	50	4	0,15	8,28	36x29x65
8170B	with red swing cover	50	4	0,15	8,28	36x29x65
8170C	with yellow swing cover	50	4	0,15	8,28	36x29x65
8170E	with grey swing cover	50	4	0,15	8,28	36x29x65
8170F	with green swing cover	50	4	0,15	8,28	36x29x65
8170G	with brown swing cover	50	4	0,15	8,28	36x29x65



Linking system for Patty bins

REF.	NOTES
P190938D	for Patty 25 L
P190939D	for Patty 50 L



White plastic bin without cover



REF.	NOTES	CAPACITY (L)	PCK	VOLUME (m <sup>3</sup> )	GROSS WEIGHT (kg)	SIZE (cm) ↓ ↓ ↓
8162/1		12	4	0,041	1,92	24x19x30
8169/1		25	4	0,095	4,41	32x25x40
8170/1		50	4	0,15	5,98	38,5x30x50





PLASTIC BAG HOLDERS

CHROME WASTE BAG HOLDER TROLLEYS

PAPER HOLDERS

BINS FOR LARGE AREAS

**BINS FOR SEPARATE WASTE COLLECTION**

SANITARY BINS

White cover with coloured swing for Patty bin



REF.	NOTES	
60193	for Patty 12 L	
60193A	for Patty 12 L	
60193B	for Patty 12 L	
60193C	for Patty 12 L	
60193	for Patty 12 L	
60193F	for Patty 12 L	
60193G	for Patty 12 L	
60185	for Patty 25 L	
60185A	for Patty 25 L	
60185B	for Patty 25 L	
60185C	for Patty 25 L	
60185E	for Patty 25 L	
60185F	for Patty 25 L	
60185G	for Patty 25 L	
60119	for Patty 50 L	
60119A	for Patty 50 L	
60119B	for Patty 50 L	
60119C	for Patty 50 L	
60119E	for Patty 50 L	
60119F	for Patty 50 L	
60119G	for Patty 50 L	

## Patty bins with pedal

**PATTY** - plastic white bin with cover and pedal



REF.	NOTES	CAPACITY (L)	PCK	VOLUME (m³)	GROSS WEIGHT (kg)	SIZE (cm) ↓ ↓ ↓
8169/2		25	4	0,105	6,89	34x28x47
8170/2		50	4	0,174	10,23	34,5x41x58

Plastic bin with handle for Patty bin



REF.	NOTES	CAPACITY (L)	PCK	VOLUME (m³)	GROSS WEIGHT (kg)	SIZE (cm) ↓ ↓ ↓	
8168A	for Patty cod. 8170/2		16	18	0,258	19,89	26x16x50
8168B	for Patty cod. 8170/2		16	18	0,258	20,86	26x16x50
8168C	for Patty cod. 8170/2		16	18	0,258	20,86	26x16x50
8168F	for Patty cod. 8170/2		16	18	0,258	20,86	26x16x50
8168U			16	18	0,258	20,86	26x16x50
8168/1A	for Patty cod. 8169/2		10	22	0,194	12,79	21x13,5x36
8168/1B	for Patty cod. 8169/2		10	22	0,194	12,79	21x13,5x36
8168/1U			10	22	0,194	12,79	21x13,5x36







PLASTIC BAG HOLDERS

CHROME WASTE BAG  
HOLDER TROLLEYS

PAPER HOLDERS

BINS FOR LARGE AREAS

**BINS FOR SEPARATE  
WASTE COLLECTION**

SANITARY BINS

## Sally bins

**SALLY** - plastic bin with cover and pedal



REF.	NOTES	CAPACITY (L)	PCK	VOLUME (m³)	GROSS WEIGHT (kg)	SIZE (cm) ↓ ↓ ↓
<b>0000C01017D</b>		17	3	0,058	4,35	20x42x46
<b>0000C01023D</b>		23	3	0,067	5,33	20x42x59



Rilsan coated wall-fixing support for Sally and Desy bins



REF.	NOTES
<b>R2180400</b>	only for Sally-Desy 17 L

## Steel bins

**POIS** -chromed steel bin with pedal opening



REF.	NOTES	CAPACITY (L)	PCK	VOLUME (m³)	GROSS WEIGHT (kg)
<b>00005836</b>	ø 17 x 26.5 cm	3	6	0,072	5,04
<b>00005835</b>	ø 20,5 x 29,5 cm	5	4	0,075	5,55
<b>00005830</b>	ø 25 x 40 cm	12	2	0,073	4,42



Stainless steel bin with hemispherical swing lid



REF.	NOTES	CAPACITY (L)	PCK	VOLUME (m³)	GROSS WEIGHT (kg)
<b>00005852</b>	ø 25.5 x 60 cm	25	1	0,044	2,3
<b>00005851</b>	ø 30.5 x 66 cm	35	1	0,06	2,9
<b>00005850</b>	ø 35.5 x 76 cm	50	1	0,083	3,7

**NEW**



PLASTIC BAG HOLDERS

CHROME WASTE BAG HOLDER TROLLEYS

PAPER HOLDERS

BINS FOR LARGE AREAS

**BINS FOR SEPARATE WASTE COLLECTION**

SANITARY BINS

Stainless steel bin with flat swing lid

**NEW**



REF.	NOTES	CAPACITY (L)	PCK	VOLUME (m <sup>3</sup> )	GROSS WEIGHT (kg)
00005861	ø 25 x 48.5 cm	25	1	0,044	2,25
00005860	ø 35 x 57.5 cm	40	1	0,083	3,97

The handy and coloured **Pick-up** containers have been designed for a green, hygienic and intelligent waste collection system. These bins are stackable; they have a front cover which can be fixed to the upper bin, saving space and making the waste collection operations quicker and easier. The colours and plates indicate the content of the bin.



Pick-up bins can be equipped with pivoting wheels to handle and transport them easier, especially during loading and unloading.

WASTE COLLECTION

## Pick-Up bins

**PICK-UP** - plastic bin 45 L without wheels, complete with cover and screen printed plastic plate



REF.	NOTES	PCK	VOLUME (m <sup>3</sup> )	GROSS WEIGHT (kg)	SIZE (cm)	
3667A	with image "paper"		4	0,095	8,1	31,5x51x30
3667B	with image "metal"		4	0,095	8,1	31,5x51x30
3667C	with image "plastic"		4	0,095	8,1	31,5x51x30
3667E	with image "non-recyclable waste"		4	0,095	8,1	31,5x51x30
3667F	with image "glass"		4	0,095	8,1	31,5x51x30
3667G	with image "organic waste"		4	0,095	8,1	31,5x51x30
3667T	without image		4	0,095	8,1	31,5x51x30

## Components and accessories for Pick-up bin

Plastic bin 45 L without cover for Pick-Up bin



REF.	NOTES	PCK	VOLUME (m <sup>3</sup> )	GROSS WEIGHT (kg)
3645A		4	0,095	5,82
3645B		4	0,095	5,82
3645C		4	0,095	5,82
3645E		4	0,095	5,82
3645F		4	0,095	5,82
3645G		4	0,095	5,82
3645T		4	0,095	5,82



PLASTIC BAG HOLDERS

CHROME WASTE BAG  
HOLDER TROLLEYS

PAPER HOLDERS

BINS FOR LARGE AREAS

**BINS FOR SEPARATE  
WASTE COLLECTION**

SANITARY BINS

## Plastic cover for Pick-Up bin



REF.	NOTES	
3648A	with image "paper"	
3648B	with image "metal"	
3648C	with image "plastic"	
3648E	with image "non-recyclable waste"	
3648F	with image "glass"	
3648G	with image "organic waste"	
3648T	without image	

## Screen printed plastic plate with image for separate waste collection



REF.	NOTES
601421	with image "metal"
601422	with image "paper"
601424	with image "organic waste"
601425	with image "plastic"
601426	with image "glass"
601428	with image "non-recyclable waste"

## Wheel ø 35 mm



REF.	NOTES
2793	for Prisma, Twin, Top-Down®, Pick-Up, Trend and art. 0000SE1428

## Wheel ø 50 mm



REF.	NOTES
7949	for King, Spider, Ro-cket Wheels, Prisma, Twin, Top-Down®, Pick-Up, Trend and art. 0000SE1428

## Domino bins

### DOMINO - plastic bin 25 L with 2 small oval plastic containers and plates



REF.	NOTES	PCK	VOLUME (m³)	GROSS WEIGHT (kg)	SIZE (cm) ↓ ↓ ↓
10300		1	0,045	2,22	24,5x46x36

### DOMINO - plastic bin 25 L with 1 small oval plastic container and 1 rectangular plastic container



REF.	NOTES	PCK	VOLUME (m³)	GROSS WEIGHT (kg)	SIZE (cm) ↓ ↓ ↓
10305		1	0,045	2,18	24,5x46x36



PLASTIC BAG HOLDERS

CHROME WASTE BAG  
HOLDER TROLLEYS

PAPER HOLDERS

BINS FOR LARGE AREAS

**BINS FOR SEPARATE  
WASTE COLLECTION**

SANITARY BINS

## DOMINO - plastic bin 2x12 L with double cover



REF.	NOTES	PCK	VOLUME (m³)	GROSS WEIGHT (kg)	SIZE (cm) ↓ ↓ ↓
10315		1	0,038	2,53	28x49x36,5

## Components and accessories for Domino bin

### Plastic bin 25 L for Domino bin



REF.	NOTES	PCK	VOLUME (m³)	GROSS WEIGHT (kg)	SIZE (cm) ↓ ↓ ↓
10200		4	0,091	5,25	24,5x46x36

### Oval container 3 L with cover for Domino bin



REF.	NOTES	PCK	VOLUME (m³)	GROSS WEIGHT (kg)
10201		4	0,019	1,52

### Rectangular container 2 L with cover for Domino bin



REF.	NOTES	PCK	VOLUME (m³)	GROSS WEIGHT (kg)
10202		4	0,009	1,29

### Bin 12 L with handle for Domino art. 10315



REF.	NOTES	PCK	GROSS WEIGHT (kg)	SIZE (cm) ↓ ↓ ↓
10250		1	0,72	24x28x36



PLASTIC BAG HOLDERS

CHROME WASTE BAG  
HOLDER TROLLEYS

PAPER HOLDERS

BINS FOR LARGE AREAS

**BINS FOR SEPARATE  
WASTE COLLECTION**

SANITARY BINS

Double cover for Domino art. 10315 complete with set of coloured plates



REF.	NOTES
10203	

Set of coloured plates for Domino bin



REF.	NOTES
10204	

## Bins with metal handle

Plastic bin 12 L with metal handle and cover with locking key



REF.	NOTES	PCK	VOLUME (m <sup>3</sup> )	GROSS WEIGHT (kg)	SIZE (cm) ↓ ↓ ↓
0000C02012U		1	0,02	0,88	26x21x36



Thanks to its locking key, it is possible to transport chemical and/or toxic products inside the bin safely

Plastic bin 12 L with cover and metal handle



REF.	NOTES	CAPACITY (L)	PCK	VOLUME (m <sup>3</sup> )	GROSS WEIGHT (kg)	SIZE (cm) ↓ ↓ ↓
8145G		12	4	0,052	2,12	27x22x30,5

**Desy** is a bin for lady's sanitary towels with a modern design, that fulfils the specific needs of hygiene.  
**Delivered already assembled and packed one piece per box.**

Also available with the **new 10 l capacity**, in the free-standing version and in the wall version for narrow bathrooms.



Desy 10 L bin



Desy 10 L wall mounted bin



Cover opening with a peculiar design that inhibits the sight of the content and prevents the release of any odour.



It is equipped with bag stretcher and cage for deodorant pills.



It has a particular fixing system of the cover which allows to remove it very easily and quickly, if necessary.

WASTE COLLECTION

## Desy bins

### DESY - plastic bin 10 L with cover and pedal for sanitary towels



REF.	NOTES	CAPACITY (L)	PCK	VOLUME (m³)	GROSS WEIGHT (kg)	SIZE (cm) ↓ ↓ ↓
0000C02010DE		10	1	0,034	1,6	18x35,7x43,5



### DESY - plastic bin 10 L for sanitary towels with cover, pedal and fixing kit for wall



REF.	NOTES	CAPACITY (L)	PCK	VOLUME (m³)	GROSS WEIGHT (kg)	SIZE (cm) ↓ ↓ ↓
0000C02910DE		10	1	0,034	2,25	18x35,7x43,5





PLASTIC BAG HOLDERS

CHROME WASTE BAG  
HOLDER TROLLEYS

PAPER HOLDERS

BINS FOR LARGE AREAS

BINS FOR SEPARATE  
WASTE COLLECTION

**SANITARY BINS**

## DESY - plastic bin with cover and pedal for sanitary towels



REF.	NOTES	CAPACITY (L)	PCK	VOLUME (m³)	GROSS WEIGHT (kg)	SIZE (cm) ↓ ↓ ↓
0000C02017DE		17	1	0,049	1,93	20x42x54
0000C02023DE		23	1	0,06	2,22	20x42x65



## Rilsan coated wall-fixing support for Sally and Desy bins



REF.	NOTES
R2180400	only for Sally-Desy 17 L

## Kiddy bins

### KIDDY - plastic bin 23 L with cover and pedal for kids' diapers



REF.	NOTES	PCK	VOLUME (m³)	GROSS WEIGHT (kg)	SIZE (cm) ↓ ↓ ↓
0000C03023D		1	0,069	2,57	20x42x67

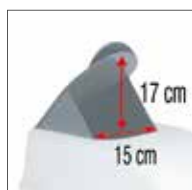

Ideal for crèches and nursery schools

## Patty for Lady bins

### PATTY FOR LADY - plastic bin 25 L with cover and pedal for sanitary towels



REF.	NOTES	PCK	VOLUME (m³)	GROSS WEIGHT (kg)	SIZE (cm) ↓ ↓ ↓
0000C02025D		1	0,042	2,46	34x32x52





# Multipurpose trolleys



Alpha

Morgan

Chromed and Rilsan  
coated trolleys







## EVOLUTION CONTINUES

**NEW**

### DRIVE LINE

Versions with electric motor and control console, for managing loads on any type of flat or sloping floor surface without strain and in full safety.



Pag. **244**

### METAL FREE LINE

Specific version, unique in the market, designed to enter freely into the magnetic resonance areas and in the areas where it is not allowed to use any magnetizable equipment.



Pag. **246**

### ALPHASPLIT LINE

Versions designed to meet specific needs:

- Waste collection: possibility to customized it up to 8 different compartments for waste collection
- Optimization of spaces: the main cleaning operations (waste collection, storage and washing) are all organized in a minimal space



Pag. **247**

### LINK-UP LINE

Versions equipped with the new system of hooks which allows to separate the different compartments of the trolley in order to make them independently.



Pag. **254**

### GENERAL LINE

Specific versions ideal to for all the cleaning operations: waste collection, storage of cleaning tools.



Pag. **257**

### WET MOPPING LINE

Specific versions ideal for all the cleaning operations: waste collection, storage of consumables and cleaning tools, dusting and wet mopping of floors and surfaces.



Pag. **266**

### HEALTHCARE LINE

Versions designed to meet the various needs of cleaning and disinfection in healthcare environments, with pre-impregnation systems or "on demand" impregnation with Equodose.



Pag. **279**



**ALPHA**

MORGAN

CHROMED AND RILSAN COATED TROLLEYS



**Alpha** is an innovative line of multipurpose trolleys designed to meet any cleaning need and request. Alpha trolleys can be employed both with the traditional wet mopping system with buckets and wringers and with the more recent wet mopping system such as pre-soaking and mop pre-soaking on demand. Since 2013 these trolleys have been certified "Plastic Second Life", as they are made of recycled plastic materials, according to the **Green Public Procurements** environmental policies.



**A tailor-made trolley with endless solutions**

- Modular
- Complete range of components and accessories to create your customized trolley

**Eco-friendly product**

- Certified "Plastic Second Life"
- 100% recyclable
- Quality 100% Made in Italy



**Modern design and customizable**

- Thanks to its soft and well designed lines this product is elegant, nice and pleasant to the eye
- Walls and doors can be customized with drawings, pictures or logos upon request

**Safe**

- It avoids the contact with any dangerous cleaning tool or chemical product
- Intelligent locking system: just one universal key



**Ergonomic**

- Light and easy to handle
- Ergonomic push-bar adjustable in height in order to suit the end user's height
- "Hush" system for a soft and silent closing of the cover

**100% full space**

- All that you need for a complete cleaning with minimum possible overall dimension and without waste of space

**Hygienic**

- Waste collection compartment separated from mopping and storage compartments
- Easy to clean thanks to its smooth and round surfaces



ALPHA

MORGAN

CHROMED AND RILSAN COATED TROLLEYS

## Some peculiarity

### BEST PERFORMANCE IN THE MINIMUM SPACE

The innovative 90 L bag holder with removable drawer allows to concentrate collection areas, washing and storage in only 86x58 cm.



### HIGHEST ERGONOMICS

The new ergonomic push-bar is easily adjustable with a click in order to suit the end user's height and grant the right working posture.



### WHEN, WHERE AND HOW YOU WANT

Thanks to **Equodose**, the innovating mechanical dosing device developed by Filmop, you can make the mop soaking on demand directly on site. The dosage can be adjusted according to the specific characteristics of mops and the surface to be cleaned.



### HIGH SAFETY AND ACCIDENT PREVENTION

**Alpha Metal Free** is the first metal-free cleaning trolley, designed to enter magnetic resonance areas without any problem.

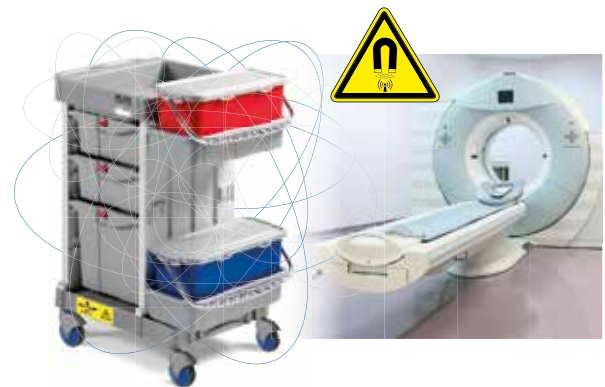

### GREAT FREEDOM OF MOVEMENT

Thanks to the hook system **Link-Up** is possible to separate the bag holder compartment from the rest of the trolley with a simply click, for an easy access even in very limited spaces such as elevators, small halls and laundries.





## WHY A MOTOR-DRIVEN TROLLEY

- **Safeguard of the health of the operator:** heavy loads can be moved without strain, preventing the occurrence of work-related illnesses and muscle-skeletal issues
- **Manoeuvrability on different surfaces:** easy to manage and manoeuvre also on surfaces normally causing difficulties, such as outdoor pavements and carpet
- **Manoeuvrability on sloping surfaces:** maximum safety during the transport of heavy loads on up and down slopes of varying levels

## **NEW** Alpha Drive motor-driven multipurpose trolleys

Filmop has conceived a range of motor-driven trolleys specifically for **making cleaning activities easier for the operator:** with Alpha Drive it is in fact possible to exploit the maximum trolley capacity, making relocations easier without any strain for the operator.



- **Powerful:** loading capacity up to 150 kg and the possibility of easily tackling all types of floors with slopes up to 12°
- **Safe:** simple and immediate emergency STOP system and different acceleration speeds for forward and reverse travel
- **Easy:** the practical and intuitive console provides easy control of the motor-driven trolley, which can be manoeuvred in the same way as traditional models
- **Customisable:** it is possible to select the desired forward travel speed, and indoor or outdoor wheels, depending on specific needs
- **Functional :** the lithium battery offers up to 8 hours of use, while the USB socket can be used to recharge mobile phones and tablets
- **Quiet:** the extremely quiet operation makes it ideal for locations where noise is an issue, such as hospitals and hotels

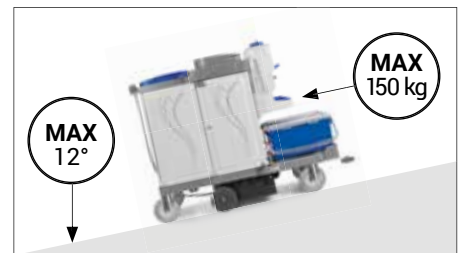

Insertion of the key in the console and switching on



**FORWARD** travel button



**REVERSE** travel button



**STOP** button (forward/reverse travel)



## EPD: Filmop's latest green goal



**EPD**<sup>®</sup>

In 2017 Filmop has obtained the **Environmental Product Declaration** for the **Alpha 260670** cleaning trolley equipped with hermetic **Top-Down** buckets.

This Declaration, better known as **EPD** (Environmental Product Declaration), is a document that communicates verified, transparent and comparable information about the life-cycle environmental impact of products and services, helping the development of the concept of green required by the European Union.

EPD is a **type III eco-label**: with this document Filmop has decided to grant **detailed information** on its production process, based on the evaluation of **LCA** (Life Cycle Assessment) as a system to identify and quantify the environmental impacts, estimating and declaring the uncertainty value for each impact category according to UNI 11698:2017 rule.

### Flow chart of the life cycle phases

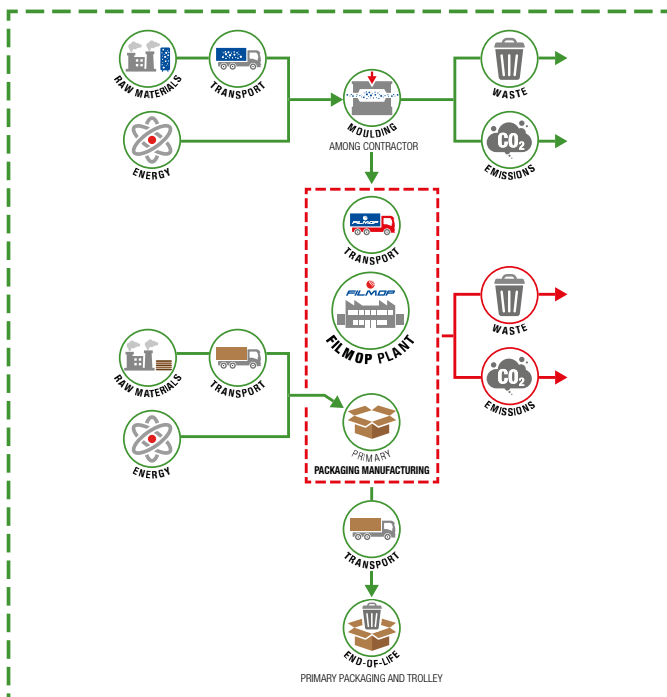

--- Company limit  
 --- System limit

### ALPHA 2606701 - plastic trolley

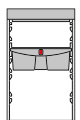

REF.	PCK	VOLUME (m <sup>3</sup> )	GROSS WEIGHT (kg)	SIZE (cm)
<b>MA2606701U000</b>	1	0,372	27,7	118x58x110
0000SE0108A	Blue plastic bucket 8 L with plastic handle			1 pc.
0000SE0108B	Red plastic bucket 8 L with plastic handle			1 pc.
0000SE0108C	Yellow plastic bucket 8 L with plastic handle			1 pc.
0000SE1322A	TOP-DOWN® - blue plastic bucket 20 L with plastic handle and hermetic cover			1 pc.
0000SE1322B	TOP-DOWN® - red plastic bucket 20 L with plastic handle and hermetic cover			1 pc.
0000SM00165	Set of T-shaped light grey closing plugs for vertical frames (6 pcs)			2 pc.
P066061U	Long base with wheels ø 125 mm			1 pc.
P1191100U	Side plastic basket			1 pc.
P165000U	Base extension for Alpha trolleys and for the bag supporting plastic plate of the Morgan Hotel Elegance trolleys			1 pc.
P2039903E	Vertical frame, 1 side with slides + 1 side for T-plugs, complete with screws and plugs			2 pc.
P206030U	1x40 L + 1x80 L plastic divider for plastic bag holder 120 L			1 pc.
P2229906U	Plastic sliding drawer 22 L with lock			1 pc.
P2909920U	Closing profile for central basket/bag holder complete with screws and plugs			1 pc.
P3059953E	Fixed side wall with fixing pins			1 pc.
P3059954E	Right door with fixing pins			1 pc.
P3199905U	Central plastic frame with grey cover with locking key and 2 shock absorbing pistons for versions with 3 hanging buckets 8 L			1 pc.
P8161111U	120L waste bag holder, male fitting, with dustpan hook and handle clip			1 pc.

### ACCESSORIES TO ORDER AS SEPARATE ITEMS

0000AT0160A	Blue plastic-coated bag 57x98 cm, maximum capacity 80 L	1 pc.
0000AT0170B	Red plastic-coated bag 48x95 cm, maximum capacity 60 L	1 pc.
P291918A	Blue cover for bag holder 120 L	1 pc.

### ON REQUEST, WITH SURCHARGE

	Rubber wheels ø 125 mm	TROLLEY REF. MA2603701U000
	Wheels ø 100 mm	TROLLEY REF. MA2601701U000



ALPHA

MORGAN

CHROMED AND RILSAN COATED TROLLEYS

## Drive Line

### ALPHA DRIVE 3848400 - plastic trolley

**NEW**

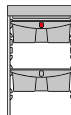

REF.	PCK	VOLUME (m³)	GROSS WEIGHT (kg)	SIZE (cm)
<b>MA3848400U002</b>	1	1,86	77,5	139x68x120
0000SE0204UA	Grey plastic bucket 4 L with blue upper plastic handle	1 pc.		
0000SE0204UB	Grey plastic bucket 4 L with red upper plastic handle	1 pc.		
0000SE0204UC	Grey plastic bucket 4 L with yellow upper plastic handle	1 pc.		
0000SE0204UF	Grey plastic bucket 4 L with green upper plastic handle	1 pc.		
0000SM00165	Set of T-shaped light grey closing plugs for vertical frames (6 pcs)	2 pc.		
3048	Set of 3 stickers for buckets	1 pc.		
7004A	REGULAR - blue plastic down-press wringer with plastic gears	1 pc.		
8108A	Blue plastic bucket 15 L with plastic handle	1 pc.		
8108B	Red plastic bucket 15 L with plastic handle	1 pc.		
P066481U	Long base with 2 ø 200x45 mm wheels, 2 bumpers and motor kit	1 pc.		
P1229906U	Grey plastic sliding drawer drawer 22 L without locking key	1 pc.		
P1909937U	Plastic lift for buckets, with holes for bottles, fitting drawers 22 and 40 L	1 pc.		
P2039903E	Vertical frame, 1 side with slides + 1 side for T-plugs, complete with screws and plugs	2 pc.		
P2229906U	Plastic sliding drawer 22 L with lock	1 pc.		
P2909912U	Divider for bag holder 150 L	1 pc.		
P2909920U	Closing profile for central basket/bag holder complete with screws and plugs	1 pc.		
P2909946A	Blue cover for bag holder 150 L with check list holder	1 pc.		
P3059953E	Fixed side wall with fixing pins	3 pcs		
P3059954E	Right door with fixing pins	1 pc.		
P3199903U	Central ring for 4l buckets complete with lockable grey lid and 2 pistons	1 pc.		
P3909952E	Door with fixing pins for bag holder	1 pc.		
P515480U	Appendage with 2 x 200x45mm ø castors and 2 locking pins	1 pc.		
P8169905U	150l waste bag holder for Alpha standard and 90l for AlphaSplit, male fitting, with hooks, pistons, screws and plugs	1 pc.		
R1040010	Rilsan coated wringer support complete with screws	1 pc.		

#### ACCESSORIES TO ORDER AS SEPARATE ITEMS

0000AT0160A	Blue plastic-coated bag 57x98 cm, maximum capacity 80 L	1 pc.
0000AT0160B	Red plastified bag 57x98 cm, capacity 80 L	1 pc.
00BL1000	Lithium battery	1 pc.
P2909915U	Pedal set for Alpha trolleys with long base or compact, closed bag holder 150 L and wheels ø 100 mm	1 pc.

#### ON REQUEST, WITH SURCHARGE



### ALPHA DRIVE 0848703 - plastic trolley

**NEW**

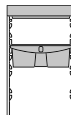

REF.	PCK	VOLUME (m³)	GROSS WEIGHT (kg)	SIZE (cm)
<b>MA0848703U000</b>	1	1,71	69,6	120x58x124
0000SE0104A	Blue plastic bucket 4 L with plastic handle	1 pc.		
0000SE0104B	Red plastic bucket 4 L with plastic handle	1 pc.		
0000SE0104C	Yellow plastic bucket 4 L with plastic handle	1 pc.		
0000SE0104F	Green plastic bucket 4 L with plastic handle	1 pc.		
0000SE1322A	TOP-DOWN® - blue plastic bucket 20 L with plastic handle and hermetic cover	1 pc.		
0000SE1322B	TOP-DOWN® - red plastic bucket 20 L with plastic handle and hermetic cover	1 pc.		
0000SM00165	Set of T-shaped light grey closing plugs for vertical frames (6 pcs)	2 pc.		
3048	Set of 3 stickers for buckets	1 pc.		
P1191100U	Side plastic basket	2 pc.		
P1229906U	Grey plastic sliding drawer drawer 22 L without locking key	1 pc.		
P2039903E	Vertical frame, 1 side with slides + 1 side for T-plugs, complete with screws and plugs	2 pc.		
P2199906U	Central plastic basket (female-female version) complete with caps	1 pc.		
P266481U	Long base with 2 ø 200x45 mm wheels, 4 bumpers and motor kit	1 pc.		
P2909912U	Divider for bag holder 150 L	1 pc.		
P2909920U	Closing profile for central basket/bag holder complete with screws and plugs	1 pc.		
P2909946A	Blue cover for bag holder 150 L with check list holder	1 pc.		
P3059953E	Fixed side wall with fixing pins	3 pcs		
P3059954E	Right door with fixing pins	1 pc.		
P3909952E	Door with fixing pins for bag holder	1 pc.		
P8169905U	150l waste bag holder for Alpha standard and 90l for AlphaSplit, male fitting, with hooks, pistons, screws and plugs	1 pc.		

#### ACCESSORIES TO ORDER AS SEPARATE ITEMS

0000AT0160A	Blue plastic-coated bag 57x98 cm, maximum capacity 80 L	1 pc.
0000AT0160B	Red plastified bag 57x98 cm, capacity 80 L	1 pc.
00BL1000	Lithium battery	1 pc.
P2909962U	Pedal set for Alpha trolleys with long base or compact, closed bag holder 150 L and wheels ø 125 mm	1 pc.

#### ON REQUEST, WITH SURCHARGE



# Multipurpose trolleys



ALPHA

MORGAN

CHROMED AND RILSAN COATED TROLLEYS

## ALPHA DRIVE 3848711 - plastic trolley

**NEW**



Equodose®  
NOT INCLUDED

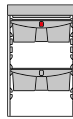

REF.	PCK	VOLUME (m³)	GROSS WEIGHT (kg)	SIZE (cm)
<b>MA3848711U000</b>	1	1,86	77,5	153x58x120
0000SE0204UA	Grey plastic bucket 4 L with blue upper plastic handle	1 pc.		
0000SE0204UB	Grey plastic bucket 4 L with red upper plastic handle	1 pc.		
0000SE0204UC	Grey plastic bucket 4 L with yellow upper plastic handle	1 pc.		
0000SE0204UF	Grey plastic bucket 4 L with green upper plastic handle	1 pc.		
0000SE1322A	TOP-DOWN® - blue plastic bucket 20 L with plastic handle and hermetic cover	1 pc.		
0000SE1322B	TOP-DOWN® - red plastic bucket 20 L with plastic handle and hermetic cover	1 pc.		
0000SM00165	Set of T-shaped light grey closing plugs for vertical frames (6 pcs)	2 pc.		
3048	Set of 3 stickers for buckets	1 pc.		
P066481U	Long base with 2 ø 200x45 mm wheels, 2 bumpers and motor kit	1 pc.		
P1229906U	Grey plastic sliding drawer 22 L without locking key	1 pc.		
P165001U	Plastic extension for Alpha base	1 pc.		
P1909937U	Plastic lift for buckets, with holes for bottles, fitting drawers 22 and 40 L	1 pc.		
P2039903E	Vertical frame, 1 side with slides + 1 side for T-plugs, complete with screws and plugs	2 pc.		
P2229906U	Plastic sliding drawer 22 L with lock	1 pc.		
P2909912U	Divider for bag holder 150 L	1 pc.		
P2909920U	Closing profile for central basket/bag holder complete with screws and plugs	1 pc.		
P2909946A	Blue cover for bag holder 150 L with check list holder	1 pc.		
P3059953E	Fixed side wall with fixing pins	3 pcs		
P3059954E	Right door with fixing pins	1 pc.		
P3199903U	Central ring for 4l buckets complete with lockable grey lid and 2 pistons	1 pc.		
P3909952E	Door with fixing pins for bag holder	1 pc.		
P515480U	Appendage with 2 x 200x45mm ø castors and 2 locking pins	1 pc.		
P8169905U	150l waste bag holder for Alpha standard and 90l for AlphaSplit, male fitting, with hooks, pistons, screws and plugs	1 pc.		

### ACCESSORIES TO ORDER AS SEPARATE ITEMS

0000AT0160A	Blue plastic-coated bag 57x98 cm, maximum capacity 80 L	1 pc.
0000AT0160B	Red plastified bag 57x98 cm, capacity 80 L	1 pc.
00BL1000	Lithium battery	1 pc.
P2909962U	Pedal set for Alpha trolleys with long base or compact, closed bag holder 150 L and wheels ø 125 mm	1 pc.
P320200UA	EQUODOSE - dosing device with two tanks 6 L for mop soaking on demand	1 pc.

### ON REQUEST, WITH SURCHARGE



wheels with rubber tyres for exterior use ø 200x50 mm

TROLLEY REF.  
**MA3849711U000**



ALPHA

MORGAN

CHROMED AND RILSAN COATED TROLLEYS

## Metal Free Line

### ALPHA METAL FREE 0236704 - plastic trolley



### ALPHA METAL FREE 3336700 - plastic trolley



REF.	PCK	VOLUME (m <sup>3</sup> )	GROSS WEIGHT (kg)	SIZE (cm) ↓ ↓ ↓
<b>MX0236704U000</b>	1	0,372	23,47	85x58x112
0000SE1322A	TOP-DOWN® - blue plastic bucket 20 L with plastic handle and hermetic cover			1 pc.
0000SE1322B	TOP-DOWN® - red plastic bucket 20 L with plastic handle and hermetic cover			1 pc.
0000SM00165	Set of T-shaped light grey closing plugs for vertical frames (6 pcs)			2 pc.
0000SM00639	Uni-Move 2 handle holder kit			1 pc.
P059361UX	Short plastic base with rubber wheels ø 125 mm for Alpha Metal Free trolley			1 pc.
P1191100U	Side plastic basket			2 pc.
P2039903EX	Vertical frame, 1 side with slides + 1 side for T-plugs, complete with screws and plugs			2 pc.
P2199906U	Central plastic basket (female-female version) complete with caps			1 pc.
P2229906UX	Plastic sliding drawer 22 L with lock for Alpha Metal Free trolley			2 pc.
P2229907UX	Plastic sliding drawer 40 L with lock for Alpha Metal Free trolley			1 pc.
P2909920UX	Closing profile for central basket/bag holder complete with screws and plugs for Alpha Metal Free trolley			1 pc.
P2909921UX	Closing profile with push-grip for central basket complete with screws and plugs for Alpha Metal Free trolley			1 pc.

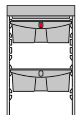

REF.	PCK	VOLUME (m <sup>3</sup> )	GROSS WEIGHT (kg)	SIZE (cm) ↓ ↓ ↓
<b>MX3336700U001</b>	1	0,372	27,97	118x58x110
0000SE0204UA	Grey plastic bucket 4 L with blue upper plastic handle			1 pc.
0000SE0204UB	Grey plastic bucket 4 L with red upper plastic handle			1 pc.
0000SE0204UC	Grey plastic bucket 4 L with yellow upper plastic handle			1 pc.
0000SE0204UF	Grey plastic bucket 4 L with green upper plastic handle			1 pc.
0000SE1322A	TOP-DOWN® - blue plastic bucket 20 L with plastic handle and hermetic cover			1 pc.
0000SE1322B	TOP-DOWN® - red plastic bucket 20 L with plastic handle and hermetic cover			1 pc.
0000SM00165	Set of T-shaped light grey closing plugs for vertical frames (6 pcs)			2 pc.
3048	Set of 3 stickers for buckets			1 pc.
P059361UX	Short plastic base with rubber wheels ø 125 mm for Alpha Metal Free trolley			1 pc.
P1191100U	Side plastic basket			2 pc.
P1229906UX	Plastic sliding drawer 22 L without lock for Alpha Metal Free trolley			1 pc.
P165000U	Base extension for Alpha trolleys and for the bag supporting plastic plate of the Morgan Hotel Elegance trolleys			1 pc.
P1909937U	Plastic lift for buckets, with holes for bottles, fitting drawers 22 and 40 L			1 pc.
P2039903EX	Vertical frame, 1 side with slides + 1 side for T-plugs, complete with screws and plugs			2 pc.
P206030U	1x40 L + 1x80 L plastic divider for plastic bag holder 120 L			1 pc.
P2229906UX	Plastic sliding drawer 22 L with lock for Alpha Metal Free trolley			1 pc.
P2909920UX	Closing profile for central basket/bag holder complete with screws and plugs for Alpha Metal Free trolley			1 pc.
P3059953EX	Fixed side wall with fixing inserts for Alpha Metal Free trolley			1 pc.
P3059954EX	Right door with fixing pins for Alpha Metal Free			1 pc.
P3199903UX	Central ring for 4l buckets complete with lockable grey lid and 2 pistons			1 pc.
P8161111UX	120l waste bag holder, male fitting, with hooks, screws and plugs for Alpha Metal Free trolley			1 pc.

#### ACCESSORIES TO ORDER AS SEPARATE ITEMS

0000AT0160A	Blue plastic-coated bag 57x98 cm, maximum capacity 80 L	1 pc.
0000AT0170B	Red plastic-coated bag 48x95 cm, maximum capacity 60 L	1 pc.
P291918A	Blue cover for bag holder 120 L	1 pc.



# Multipurpose trolleys



ALPHA

MORGAN

CHROMED AND RILSAN COATED TROLLEYS

## AlphaSplit Line

### ALPHASPLIT 0001101 - plastic trolley

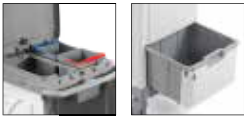



REF.	PCK	VOLUME (m³)	GROSS WEIGHT (kg)	SIZE (cm)
<b>MA0001101U000</b>	1	0,291	23,62	56x54x104
0000SE0204UA	Grey plastic bucket 4 L with blue upper plastic handle	1 pc.		
0000SE0204UB	Grey plastic bucket 4 L with red upper plastic handle	1 pc.		
0000SM00165	Set of T-shaped light grey closing plugs for vertical frames (6 pcs)	1 pc.		
I1050072	Stainless steel holder for buckets 4 L for bag holder 150 L	1 pc.		
P025011U	Compact base with wheels ø 100 mm	1 pc.		
P1909968U	Covering for bag holder 150L, foldable bag holder 120L and closing profiles	1 pc.		
P2039906E	Vertical Frame, 1 smooth side + 1 side for T-plugs, complete with screws and plugs	1 pc.		
P2059963E	Door for AlphaSplit bag holder	1 pc.		
P2229913U	Sliding plastic drawer 33L with lock for AlphaSplit	1 pc.		
P2229914U	Plastic shelf for AlphaSplit	1 pc.		
P2909912U	Divider for bag holder 150 L	1 pc.		
P2909946A	Blue cover for bag holder 150 L with check list holder	1 pc.		
P3059967E	Set right and left walls for AlphaSplit	1 pc.		
P8169905U	150l waste bag holder for Alpha standard and 90l for AlphaSplit, male fitting, with hooks, pistons, screws and plugs	1 pc.		

#### ACCESSORIES TO ORDER AS SEPARATE ITEMS

0000AT0310A	Blue plastified bag 45 L , 33x24x63 cm	1 pc.
P2909915U	Pedal set for Alpha trolleys with long base or compact, closed bag holder 150 L and wheels ø 100 mm	1 pc.

#### ON REQUEST, WITH SURCHARGE

	Rubber wheels ø125 mm TROLLEY REF. <b>MA0003101U000</b>		Wheel ø 125 mm TROLLEY REF. <b>MA0006101U000</b>		Bag holder with adjustable push-grip TROLLEY REF. <b>MA0001151U000</b>
--	--	---	---	---	---

### ALPHASPLIT 0701500 - plastic trolley





REF.	PCK	VOLUME (m³)	GROSS WEIGHT (kg)	SIZE (cm)
<b>MA0701500U000</b>	1	0,372	29,37	98x68x111
0000SE0104A	Blue plastic bucket 4 L with plastic handle	1 pc.		
0000SE0104B	Red plastic bucket 4 L with plastic handle	1 pc.		
0000SM00165	Set of T-shaped light grey closing plugs for vertical frames (6 pcs)	1 pc.		
7004A	REGULAR - blue plastic down-press wringer with plastic gears	1 pc.		
8108A	Blue plastic bucket 15 L with plastic handle	1 pc.		
8108B	Red plastic bucket 15 L with plastic handle	1 pc.		
P066011U	Long base with wheels ø 100 mm	1 pc.		
P1199900U	Upper basket	1 pc.		
P2039906E	Vertical Frame, 1 smooth side + 1 side for T-plugs, complete with screws and plugs	1 pc.		
P2059963E	Door for AlphaSplit bag holder	1 pc.		
P2229913U	Sliding plastic drawer 33L with lock for AlphaSplit	1 pc.		
P2229914U	Plastic shelf for AlphaSplit	1 pc.		
P2909912U	Divider for bag holder 150 L	1 pc.		
P2909946A	Blue cover for bag holder 150 L with check list holder	1 pc.		
P3059967E	Set right and left walls for AlphaSplit	1 pc.		
P8169905U	150l waste bag holder for Alpha standard and 90l for AlphaSplit, male fitting, with hooks, pistons, screws and plugs	1 pc.		
R1040010	Rilsan coated wringer support complete with screws	1 pc.		

#### ACCESSORIES TO ORDER AS SEPARATE ITEMS

0000AT0310A	Blue plastified bag 45 L , 33x24x63 cm	1 pc.
0000AT0310B	Red plastified bag 45 L , 33x24x63 cm	1 pc.
P2909915U	Pedal set for Alpha trolleys with long base or compact, closed bag holder 150 L and wheels ø 100 mm	1 pc.

#### ON REQUEST, WITH SURCHARGE

	Rubber wheels ø125 mm TROLLEY REF. <b>MA0703500U000</b>		Wheel ø 125 mm TROLLEY REF. <b>MA0706500U000</b>		Bag holder with adjustable push-grip TROLLEY REF. <b>MA0701550U000</b>
---	--	---	---	---	---



## ALPHA

## MORGAN

## CHROMED AND RILSAN COATED TROLLEYS

### ALPHASPLIT 0801500 - plastic trolley

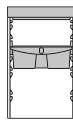

REF.	PCK	VOLUME (m³)	GROSS WEIGHT (kg)	SIZE (cm)
<b>MA0801500U000</b>	1	0,522	42,39	139x68x114

0000SE0104A	Blue plastic bucket 4 L with plastic handle	1 pc.
0000SE0104B	Red plastic bucket 4 L with plastic handle	1 pc.
0000SE0104C	Yellow plastic bucket 4 L with plastic handle	1 pc.
0000SE0104F	Green plastic bucket 4 L with plastic handle	1 pc.
0000SM00165	Set of T-shaped light grey closing plugs for vertical frames (6 pcs)	2 pc.
3048	Set of 3 stickers for buckets	1 pc.
7004A	REGULAR - blue plastic down-press wringer with plastic gears	1 pc.
8108A	Blue plastic bucket 15 L with plastic handle	1 pc.
8108B	Red plastic bucket 15 L with plastic handle	1 pc.
P066011U	Long base with wheels ø 100 mm	1 pc.
P1229906U	Grey plastic sliding drawer drawer 22 L without locking key	1 pc.
P2039903E	Vertical frame, 1 side with slides + 1 side for T-plugs, complete with screws and plugs	2 pc.
P2059963E	Door for AlphaSplit bag holder	1 pc.
P2199906U	Central plastic basket (female-female version) complete with caps	1 pc.
P2229913U	Sliding plastic drawer 33L with lock for AlphaSplit	1 pc.
P2229914U	Plastic shelf for AlphaSplit	1 pc.
P2909912U	Divider for bag holder 150 L	1 pc.
P2909920U	Closing profile for central basket/bag holder complete with screws and plugs	1 pc.
P2909946A	Blue cover for bag holder 150 L with check list holder	1 pc.
P2909966U	Bag holder insert with storage compartment and one divider for AlphaSplit	1 pc.
P3059953E	Fixed side wall with fixing pins	1 pc.
P3059954E	Right door with fixing pins	1 pc.
P3059967E	Set right and left walls for AlphaSplit	1 pc.
P515010U	Supporting plastic plate with 2 wheels ø 100 mm and 2 blocking clips	1 pc.
P8169905U	150l waste bag holder for Alpha standard and 90l for AlphaSplit, male fitting, with hooks, pistons, screws and plugs	1 pc.
R1040010	Rilsan coated wringer support complete with screws	1 pc.

### ACCESSORIES TO ORDER AS SEPARATE ITEMS

0000AT0310A	Blue plastified bag 45 L, 33x24x63 cm	1 pc.
0000AT0310B	Red plastified bag 45 L, 33x24x63 cm	1 pc.
P2909915U	Pedal set for Alpha trolleys with long base or compact, closed bag holder 150 L and wheels ø 100 mm	1 pc.

### ON REQUEST, WITH SURCHARGE

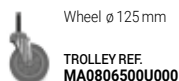

### ALPHASPLIT 0801114 - plastic trolley

**NEW**

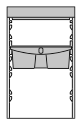

REF.	PCK	VOLUME (m³)	GROSS WEIGHT (kg)	SIZE (cm)
<b>MA0801114U000</b>	1	0,372	31,37	98x58x114

### Complete trolley sizes with OneFred 161x65x114 cm

0000SE0104A	Blue plastic bucket 4 L with plastic handle	1 pc.
0000SE0104B	Red plastic bucket 4 L with plastic handle	1 pc.
0000SE0104C	Yellow plastic bucket 4 L with plastic handle	1 pc.
0000SE0104F	Green plastic bucket 4 L with plastic handle	1 pc.
0000SM00165	Set of T-shaped light grey closing plugs for vertical frames (6 pcs)	2 pc.
3048	Set of 3 stickers for buckets	1 pc.
P066011U	Long base with wheels ø 100 mm	1 pc.
P1229906U	Grey plastic sliding drawer drawer 22 L without locking key	1 pc.
P2039903E	Vertical frame, 1 side with slides + 1 side for T-plugs, complete with screws and plugs	2 pc.
P2059963E	Door for AlphaSplit bag holder	1 pc.
P2199906U	Central plastic basket (female-female version) complete with caps	1 pc.
P2229913U	Sliding plastic drawer 33L with lock for AlphaSplit	1 pc.
P2229914U	Plastic shelf for AlphaSplit	1 pc.
P2909912U	Divider for bag holder 150 L	1 pc.
P2909920U	Closing profile for central basket/bag holder complete with screws and plugs	1 pc.
P2909946A	Blue cover for bag holder 150 L with check list holder	1 pc.
P2909966U	Bag holder insert with storage compartment and one divider for AlphaSplit	1 pc.
P3059953E	Fixed side wall with fixing pins	1 pc.
P3059954E	Right door with fixing pins	1 pc.
P3059967E	Set right and left walls for AlphaSplit	1 pc.
P8169905U	150l waste bag holder for Alpha standard and 90l for AlphaSplit, male fitting, with hooks, pistons, screws and plugs	1 pc.

### ACCESSORIES TO ORDER AS SEPARATE ITEMS

0000AT0310A	Blue plastified bag 45 L, 33x24x63 cm	1 pc.
0000AT0310B	Red plastified bag 45 L, 33x24x63 cm	1 pc.
0000LF0030YU	ONEFRED - 30 l plastic trolley with plastic handle	1 pc.
0000SM00298	PEG KIT - OneFred attachment kit for Alpha trolleys with broom holder	1 pc.
P2909915U	Pedal set for Alpha trolleys with long base or compact, closed bag holder 150 L and wheels ø 100 mm	1 pc.

### ON REQUEST, WITH SURCHARGE



# Multipurpose trolleys



ALPHA

MORGAN

CHROMED AND RILSAN COATED TROLLEYS

## ALPHASPLIT 3801500 - plastic trolley

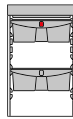

REF.	PCK	VOLUME (m³)	GROSS WEIGHT (kg)	SIZE (cm)
<b>MA3801500U000</b>	1	0,522	38	139x68x110
0000SE0204UA	Grey plastic bucket 4 L with blue upper plastic handle	1 pc.		
0000SE0204UB	Grey plastic bucket 4 L with red upper plastic handle	1 pc.		
0000SE0204UC	Grey plastic bucket 4 L with yellow upper plastic handle	1 pc.		
0000SE0204UF	Grey plastic bucket 4 L with green upper plastic handle	1 pc.		
0000SM00165	Set of T-shaped light grey closing plugs for vertical frames (6 pcs)	2 pc.		
3048	Set of 3 stickers for buckets	1 pc.		
7004A	REGULAR - blue plastic down-press wringer with plastic gears	1 pc.		
8108A	Blue plastic bucket 15 L with plastic handle	1 pc.		
8108B	Red plastic bucket 15 L with plastic handle	1 pc.		
P066011U	Long base with wheels ø 100 mm	1 pc.		
P1229906U	Grey plastic sliding drawer drawer 22 L without locking key	1 pc.		
P1909937U	Plastic lift for buckets, with holes for bottles, fitting drawers 22 and 40 L	1 pc.		
P2039903E	Vertical frame, 1 side with slides + 1 side for T-plugs, complete with screws and plugs	2 pc.		
P2059963E	Door for AlphaSplit bag holder	1 pc.		
P2229906U	Plastic sliding drawer 22 L with lock	1 pc.		
P2229913U	Sliding plastic drawer 33L with lock for AlphaSplit	1 pc.		
P2229914U	Plastic shelf for AlphaSplit	1 pc.		
P2909912U	Divider for bag holder 150 L	1 pc.		
P2909920U	Closing profile for central basket/bag holder complete with screws and plugs	1 pc.		
P2909946A	Blue cover for bag holder 150 L with check list holder	1 pc.		
P2909966U	Bag holder insert with storage compartment and one divider for AlphaSplit	1 pc.		
P3059953E	Fixed side wall with fixing pins	1 pc.		
P3059954E	Right door with fixing pins	1 pc.		
P3059967E	Set right and left walls for AlphaSplit	1 pc.		
P3199903U	Central ring for 4l buckets complete with lockable grey lid and 2 pistons	1 pc.		
P515010U	Supporting plastic plate with 2 wheels ø 100 mm and 2 blocking clips	1 pc.		
P8169905U	150l waste bag holder for Alpha standard and 90l for AlphaSplit, male fitting, with hooks, pistons, screws and plugs	1 pc.		
R1040010	Rilsan coated wringer support complete with screws	1 pc.		

### ACCESSORIES TO ORDER AS SEPARATE ITEMS

0000AT0310A	Blue plastified bag 45 L, 33x24x63 cm	1 pc.
0000AT0310B	Red plastified bag 45 L, 33x24x63 cm	1 pc.
P2909915U	Pedal set for Alpha trolleys with long base or compact, closed bag holder 150 L and wheels ø 100 mm	1 pc.

### ON REQUEST, WITH SURCHARGE

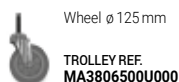

## ALPHASPLIT 0706800 - plastic trolley



REF.	PCK	VOLUME (m³)	GROSS WEIGHT (kg)	SIZE (cm)
<b>MA0706800U000</b>	1	0,372	23,3	84x58x111
0000SE0104A	Blue plastic bucket 4 L with plastic handle	1 pc.		
0000SE0104B	Red plastic bucket 4 L with plastic handle	1 pc.		
0000SE1322A	TOP-DOWN® - blue plastic bucket 20 L with plastic handle and hermetic cover	1 pc.		
0000SM00165	Set of T-shaped light grey closing plugs for vertical frames (6 pcs)	1 pc.		
P059061U	Short base with wheels ø 125 mm	1 pc.		
P1199900U	Upper basket	1 pc.		
P165001U	Plastic extension for Alpha base	1 pc.		
P2039906E	Vertical Frame, 1 smooth side + 1 side for T-plugs, complete with screws and plugs	1 pc.		
P2059963E	Door for AlphaSplit bag holder	1 pc.		
P2229913U	Sliding plastic drawer 33L with lock for AlphaSplit	1 pc.		
P2229914U	Plastic shelf for AlphaSplit	1 pc.		
P2909912U	Divider for bag holder 150 L	1 pc.		
P2909946A	Blue cover for bag holder 150 L with check list holder	1 pc.		
P3059967E	Set right and left walls for AlphaSplit	1 pc.		
P8169905U	150l waste bag holder for Alpha standard and 90l for AlphaSplit, male fitting, with hooks, pistons, screws and plugs	1 pc.		

### ACCESSORIES TO ORDER AS SEPARATE ITEMS

0000AT0310A	Blue plastified bag 45 L, 33x24x63 cm	1 pc.
0000AT0310B	Red plastified bag 45 L, 33x24x63 cm	1 pc.
P3909962U	Pedal set for trolleys with short base, bag holder 150 L and wheels ø 125 mm	1 pc.

### ON REQUEST, WITH SURCHARGE



MULTIPURPOSE TROLLEYS



## ALPHA

## MORGAN

## CHROMED AND RILSAN COATED TROLLEYS

### ALPHASPLIT 0706804 - plastic trolley

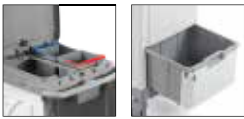

REF.	PCK	VOLUME (m³)	GROSS WEIGHT (kg)	SIZE (cm)
<b>MA0706804U000</b>	1	0,31	22,09	94x58x120
0000SE0204UA	Grey plastic bucket 4 L with blue upper plastic handle	1 pc.		
0000SE0204UB	Grey plastic bucket 4 L with red upper plastic handle	1 pc.		
0000SE1322A	TOP-DOWN® - blue plastic bucket 20 L with plastic handle and hermetic cover	1 pc.		
0000SE1322B	TOP-DOWN® - red plastic bucket 20 L with plastic handle and hermetic cover	1 pc.		
0000SM00165	Set of T-shaped light grey closing plugs for vertical frames (6 pcs)	1 pc.		
I1050072	Stainless steel holder for buckets 4 L for bag holder 150 L	1 pc.		
P059061U	Short base with wheels ø 125 mm	1 pc.		
P1191100U	Side plastic basket	1 pc.		
P165001U	Plastic extension for Alpha base	1 pc.		
P1909968U	Covering for bag holder 150L, foldable bag holder 120L and closing profiles	1 pc.		
P2039906E	Vertical Frame, 1 smooth side + 1 side for T-plugs, complete with screws and plugs	1 pc.		
P2059963E	Door for AlphaSplit bag holder	1 pc.		
P2229913U	Sliding plastic drawer 33L with lock for AlphaSplit	1 pc.		
P2229914U	Plastic shelf for AlphaSplit	1 pc.		
P2909912U	Divider for bag holder 150 L	1 pc.		
P2909946A	Blue cover for bag holder 150 L with check list holder	1 pc.		
P3059967E	Set right and left walls for AlphaSplit	1 pc.		
P8169905U	150l waste bag holder for Alpha standard and 90l for AlphaSplit, male fitting, with hooks, pistons, screws and plugs	1 pc.		

#### ACCESSORIES TO ORDER AS SEPARATE ITEMS

0000AT0310A	Blue plastified bag 45 L , 33x24x63 cm	1 pc.
P2909962U	Pedal set for Alpha trolleys with long base or compact, closed bag holder 150 L and wheels ø 125 mm	1 pc.

#### ON REQUEST, WITH SURCHARGE

	Rubber wheels ø 125 mm TROLLEY REF. MA0703804U000		Wheels ø 100 mm TROLLEY REF. MA0701804U000		Bag holder with adjustable push-grip TROLLEY REF. MA0706854U000
--	--	--	---	--	--

### ALPHASPLIT 0706805 - plastic trolley

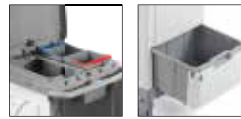

REF.	PCK	VOLUME (m³)	GROSS WEIGHT (kg)	SIZE (cm)
<b>MA0706805U000</b>	1	0,31	23,59	84x58x120
0000SE0204UA	Grey plastic bucket 4 L with blue upper plastic handle	1 pc.		
0000SE0204UB	Grey plastic bucket 4 L with red upper plastic handle	1 pc.		
0000SE1322A	TOP-DOWN® - blue plastic bucket 20 L with plastic handle and hermetic cover	1 pc.		
0000SM00165	Set of T-shaped light grey closing plugs for vertical frames (6 pcs)	1 pc.		
I1050072	Stainless steel holder for buckets 4 L for bag holder 150 L	1 pc.		
P059061U	Short base with wheels ø 125 mm	1 pc.		
P165001U	Plastic extension for Alpha base	1 pc.		
P1909968U	Covering for bag holder 150L, foldable bag holder 120L and closing profiles	1 pc.		
P2039906E	Vertical Frame, 1 smooth side + 1 side for T-plugs, complete with screws and plugs	1 pc.		
P2059963E	Door for AlphaSplit bag holder	1 pc.		
P2229913U	Sliding plastic drawer 33L with lock for AlphaSplit	1 pc.		
P2229914U	Plastic shelf for AlphaSplit	1 pc.		
P2909912U	Divider for bag holder 150 L	1 pc.		
P2909946A	Blue cover for bag holder 150 L with check list holder	1 pc.		
P3059967E	Set right and left walls for AlphaSplit	1 pc.		
P8169905U	150l waste bag holder for Alpha standard and 90l for AlphaSplit, male fitting, with hooks, pistons, screws and plugs	1 pc.		

#### ACCESSORIES TO ORDER AS SEPARATE ITEMS

0000AT0310A	Blue plastified bag 45 L , 33x24x63 cm	1 pc.
P320100UA	EQUODOSE - dosing device with one tank 6 L for mop soaking on demand	1 pc.
P3909962U	Pedal set for trolleys with short base, bag holder 150 L and wheels ø 125 mm	1 pc.

#### ON REQUEST, WITH SURCHARGE

	Rubber wheels ø 125 mm TROLLEY REF. MA0703805U000		Wheels ø 100 mm TROLLEY REF. MA0701805U000		Bag holder with adjustable push-grip TROLLEY REF. MA0706855U000
--	--	--	---	--	--

# Multipurpose trolleys



## ALPHA

## MORGAN

## CHROMED AND RILSAN COATED TROLLEYS

### ALPHASPLIT 0706806 - plastic trolley



### ALPHASPLIT 0806803 - plastic trolley

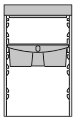
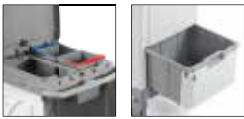

REF.	PCK	VOLUME (m <sup>3</sup> )	GROSS WEIGHT (kg)	SIZE (cm)
<b>MA0706806U000</b>	1	0,372	27,67	118x58x120
0000SE0204UA	Grey plastic bucket 4 L with blue upper plastic handle	1 pc.		
0000SE0204UB	Grey plastic bucket 4 L with red upper plastic handle	1 pc.		
0000SE1322A	TOP-DOWN® - blue plastic bucket 20 L with plastic handle and hermetic cover	1 pc.		
0000SE1322B	TOP-DOWN® - red plastic bucket 20 L with plastic handle and hermetic cover	1 pc.		
0000SM00165	Set of T-shaped light grey closing plugs for vertical frames (6 pcs)	1 pc.		
I1050072	Stainless steel holder for buckets 4 L for bag holder 150 L	1 pc.		
P066061U	Long base with wheels ø 125 mm	1 pc.		
P165001U	Plastic extension for Alpha base	1 pc.		
P1909968U	Covering for bag holder 150L, foldable bag holder 120L and closing profiles	1 pc.		
P2039906E	Vertical Frame, 1 smooth side + 1 side for T-plugs, complete with screws and plugs	1 pc.		
P2059963E	Door for AlphaSplit bag holder	1 pc.		
P2229913U	Sliding plastic drawer 33L with lock for AlphaSplit	1 pc.		
P2229914U	Plastic shelf for AlphaSplit	1 pc.		
P2909912U	Divider for bag holder 150 L	1 pc.		
P2909946A	Blue cover for bag holder 150 L with check list holder	1 pc.		
P3059967E	Set right and left walls for AlphaSplit	1 pc.		
P8169905U	150l waste bag holder for Alpha standard and 90l for AlphaSplit, male fitting, with hooks, pistons, screws and plugs	1 pc.		

REF.	PCK	VOLUME (m <sup>3</sup> )	GROSS WEIGHT (kg)	SIZE (cm)
<b>MA0806803U000</b>	1	0,488	39,64	120x58x114
0000SE0104A	Blue plastic bucket 4 L with plastic handle	1 pc.		
0000SE0104B	Red plastic bucket 4 L with plastic handle	1 pc.		
0000SE0104C	Yellow plastic bucket 4 L with plastic handle	1 pc.		
0000SE0104F	Green plastic bucket 4 L with plastic handle	1 pc.		
0000SE1322A	TOP-DOWN® - blue plastic bucket 20 L with plastic handle and hermetic cover	1 pc.		
0000SE1322B	TOP-DOWN® - red plastic bucket 20 L with plastic handle and hermetic cover	1 pc.		
0000SM00165	Set of T-shaped light grey closing plugs for vertical frames (6 pcs)	2 pc.		
3048	Set of 3 stickers for buckets	1 pc.		
P066061U	Long base with wheels ø 125 mm	1 pc.		
P1191100U	Side plastic basket	2 pc.		
P1229906U	Grey plastic sliding drawer 22 L without locking key	1 pc.		
P2039903E	Vertical frame, 1 side with slides + 1 side for T-plugs, complete with screws and plugs	2 pc.		
P2059963E	Door for AlphaSplit bag holder	1 pc.		
P2199906U	Central plastic basket (female-female version) complete with caps	1 pc.		
P2229913U	Sliding plastic drawer 33L with lock for AlphaSplit	1 pc.		
P2229914U	Plastic shelf for AlphaSplit	1 pc.		
P2909912U	Divider for bag holder 150 L	1 pc.		
P2909920U	Closing profile for central basket/bag holder complete with screws and plugs	1 pc.		
P2909946A	Blue cover for bag holder 150 L with check list holder	1 pc.		
P2909966U	Bag holder insert with storage compartment and one divider for AlphaSplit	1 pc.		
P3059953E	Fixed side wall with fixing pins	1 pc.		
P3059954E	Right door with fixing pins	1 pc.		
P3059967E	Set right and left walls for AlphaSplit	1 pc.		
P8169905U	150l waste bag holder for Alpha standard and 90l for AlphaSplit, male fitting, with hooks, pistons, screws and plugs	1 pc.		

#### ACCESSORIES TO ORDER AS SEPARATE ITEMS

0000AT0310A	Blue plastified bag 45 L, 33x24x63 cm	1 pc.
P2909962U	Pedal set for Alpha trolleys with long base or compact, closed bag holder 150 L and wheels ø 125 mm	1 pc.
P320200UA	EQUODOSE - dosing device with two tanks 6 L for mop soaking on demand	1 pc.

#### ON REQUEST, WITH SURCHARGE



#### ACCESSORIES TO ORDER AS SEPARATE ITEMS

0000AT0310A	Blue plastified bag 45 L, 33x24x63 cm	1 pc.
0000AT0310B	Red plastified bag 45 L, 33x24x63 cm	1 pc.
P2909962U	Pedal set for Alpha trolleys with long base or compact, closed bag holder 150 L and wheels ø 125 mm	1 pc.

#### ON REQUEST, WITH SURCHARGE





## ALPHA

## MORGAN

## CHROMED AND RILSAN COATED TROLLEYS

### ALPHASPLIT 0806800 - plastic trolley

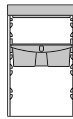

REF.	PCK	VOLUME (m <sup>3</sup> )	GROSS WEIGHT (kg)	SIZE (cm)
<b>MA0806800U000</b>	1	0,698	36,3	125x65x118
0000SE0104A	Blue plastic bucket 4 L with plastic handle	1 pc.		
0000SE0104B	Red plastic bucket 4 L with plastic handle	1 pc.		
0000SE0104C	Yellow plastic bucket 4 L with plastic handle	1 pc.		
0000SE0104F	Green plastic bucket 4 L with plastic handle	1 pc.		
0000SE1322A	TOP-DOWN® - blue plastic bucket 20 L with plastic handle and hermetic cover	1 pc.		
0000SE1322B	TOP-DOWN® - red plastic bucket 20 L with plastic handle and hermetic cover	1 pc.		
0000SM00165	Set of T-shaped light grey closing plugs for vertical frames (6 pcs)	2 pc.		
3048	Set of 3 stickers for buckets	1 pc.		
P066061U	Long base with wheels ø 125 mm	1 pc.		
P1229906U	Grey plastic sliding drawer drawer 22 L without locking key	1 pc.		
P2039903E	Vertical frame, 1 side with slides + 1 side for T-plugs, complete with screws and plugs	2 pc.		
P2059963E	Door for AlphaSplit bag holder	1 pc.		
P2199906U	Central plastic basket (female-female version) complete with caps	1 pc.		
P2229913U	Sliding plastic drawer 33L with lock for AlphaSplit	1 pc.		
P2229914U	Plastic shelf for AlphaSplit	1 pc.		
P2909912U	Divider for bag holder 150 L	1 pc.		
P2909920U	Closing profile for central basket/bag holder complete with screws and plugs	1 pc.		
P2909946A	Blue cover for bag holder 150 L with check list holder	1 pc.		
P2909966U	Bag holder insert with storage compartment and one divider for AlphaSplit	1 pc.		
P3059953E	Fixed side wall with fixing pins	1 pc.		
P3059954E	Right door with fixing pins	1 pc.		
P3059967E	Set right and left walls for AlphaSplit	1 pc.		
P8169905U	150l waste bag holder for Alpha standard and 90l for AlphaSplit, male fitting, with hooks, pistons, screws and plugs	1 pc.		
R2200040	Rilsan coated bucket holder for buckets 10 and 20 L fitting Morgan vertical frame and Alpha trolley	1 pc.		
R3030133	Square Rilsan trolley with 200mm ø wheels, plastic support, trolley retaining set and Bis hook, for 10- and 20-litre Top-Down buckets	1 pc.		

### ACCESSORIES TO ORDER AS SEPARATE ITEMS

0000AT0310A	Blue plastified bag 45 L, 33x24x63 cm	1 pc.
0000AT0310B	Red plastified bag 45 L, 33x24x63 cm	1 pc.
P2909962U	Pedal set for Alpha trolleys with long base or compact, closed bag holder 150 L and wheels ø 125 mm	1 pc.

### ON REQUEST, WITH SURCHARGE

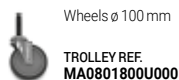

### ALPHASPLIT 3806800 - plastic trolley

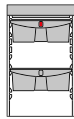

REF.	PCK	VOLUME (m <sup>3</sup> )	GROSS WEIGHT (kg)	SIZE (cm)
<b>MA3806800U000</b>	1	0,698	38,5	125x65x118
0000SE0204UA	Grey plastic bucket 4 L with blue upper plastic handle	1 pc.		
0000SE0204UB	Grey plastic bucket 4 L with red upper plastic handle	1 pc.		
0000SE0204UC	Grey plastic bucket 4 L with yellow upper plastic handle	1 pc.		
0000SE0204UF	Grey plastic bucket 4 L with green upper plastic handle	1 pc.		
0000SE1322A	TOP-DOWN® - blue plastic bucket 20 L with plastic handle and hermetic cover	1 pc.		
0000SE1322B	TOP-DOWN® - red plastic bucket 20 L with plastic handle and hermetic cover	1 pc.		
0000SM00165	Set of T-shaped light grey closing plugs for vertical frames (6 pcs)	2 pc.		
3048	Set of 3 stickers for buckets	1 pc.		
P066061U	Long base with wheels ø 125 mm	1 pc.		
P1229906U	Grey plastic sliding drawer drawer 22 L without locking key	1 pc.		
P1909937U	Plastic lift for buckets, with holes for bottles, fitting drawers 22 and 40 L	1 pc.		
P2039903E	Vertical frame, 1 side with slides + 1 side for T-plugs, complete with screws and plugs	2 pc.		
P2059963E	Door for AlphaSplit bag holder	1 pc.		
P2229906U	Plastic sliding drawer 22 L with lock	1 pc.		
P2229913U	Sliding plastic drawer 33L with lock for AlphaSplit	1 pc.		
P2229914U	Plastic shelf for AlphaSplit	1 pc.		
P2909912U	Divider for bag holder 150 L	1 pc.		
P2909920U	Closing profile for central basket/bag holder complete with screws and plugs	1 pc.		
P2909946A	Blue cover for bag holder 150 L with check list holder	1 pc.		
P2909966U	Bag holder insert with storage compartment and one divider for AlphaSplit	1 pc.		
P3059953E	Fixed side wall with fixing pins	1 pc.		
P3059954E	Right door with fixing pins	1 pc.		
P3059967E	Set right and left walls for AlphaSplit	1 pc.		
P3199903U	Central ring for 4l buckets complete with lockable grey lid and 2 pistons	1 pc.		
P8169905U	150l waste bag holder for Alpha standard and 90l for AlphaSplit, male fitting, with hooks, pistons, screws and plugs	1 pc.		
R2200040	Rilsan coated bucket holder for buckets 10 and 20 L fitting Morgan vertical frame and Alpha trolley	1 pc.		
R3030133	Square Rilsan trolley with 200mm ø wheels, plastic support, trolley retaining set and Bis hook, for 10- and 20-litre Top-Down buckets	1 pc.		

### ACCESSORIES TO ORDER AS SEPARATE ITEMS

0000AT0310A	Blue plastified bag 45 L, 33x24x63 cm	1 pc.
0000AT0310B	Red plastified bag 45 L, 33x24x63 cm	1 pc.
P2909962U	Pedal set for Alpha trolleys with long base or compact, closed bag holder 150 L and wheels ø 125 mm	1 pc.

### ON REQUEST, WITH SURCHARGE

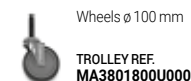

# Multipurpose trolleys



## ALPHA

## MORGAN

## CHROMED AND RILSAN COATED TROLLEYS

### ALPHASPLIT 3806809 - plastic trolley

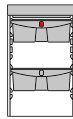

REF.	PCK	VOLUME (m³)	GROSS WEIGHT (kg)	SIZE (cm)
<b>MA3806809U000</b>	1	0,488	34,64	138x58x120
0000SE0204UA	Grey plastic bucket 4 L with blue upper plastic handle	1 pc.		
0000SE0204UB	Grey plastic bucket 4 L with red upper plastic handle	1 pc.		
0000SE0204UC	Grey plastic bucket 4 L with yellow upper plastic handle	1 pc.		
0000SE0204UF	Grey plastic bucket 4 L with green upper plastic handle	1 pc.		
0000SE1322A	TOP-DOWN® - blue plastic bucket 20 L with plastic handle and hermetic cover	1 pc.		
0000SM00165	Set of T-shaped light grey closing plugs for vertical frames (6 pcs)	2 pc.		
3048	Set of 3 stickers for buckets	1 pc.		
P066061U	Long base with wheels ø 125 mm	1 pc.		
P1229906U	Grey plastic sliding drawer drawer 22 L without locking key	1 pc.		
P1909937U	Plastic lift for buckets, with holes for bottles, fitting drawers 22 and 40 L	1 pc.		
P2039903E	Vertical frame, 1 side with slides + 1 side for T-plugs, complete with screws and plugs	2 pc.		
P2059963E	Door for AlphaSplit bag holder	1 pc.		
P2229906U	Plastic sliding drawer 22 L with lock	1 pc.		
P2229913U	Sliding plastic drawer 33L with lock for AlphaSplit	1 pc.		
P2229914U	Plastic shelf for AlphaSplit	1 pc.		
P2909912U	Divider for bag holder 150 L	1 pc.		
P2909920U	Closing profile for central basket/bag holder complete with screws and plugs	1 pc.		
P2909946A	Blue cover for bag holder 150 L with check list holder	1 pc.		
P2909966U	Bag holder insert with storage compartment and one divider for AlphaSplit	1 pc.		
P3059953E	Fixed side wall with fixing pins	1 pc.		
P3059954E	Right door with fixing pins	1 pc.		
P3059967E	Set right and left walls for AlphaSplit	1 pc.		
P3199903U	Central ring for 4l buckets complete with lockable grey lid and 2 pistons	1 pc.		
P8169905U	150l waste bag holder for Alpha standard and 90l for AlphaSplit, male fitting, with hooks, pistons, screws and plugs	1 pc.		
R1200042	Rilsan coated bucket holder for buckets 10 and 20 L fitting vertical frame Alpha line	1 pc.		

### ACCESSORIES TO ORDER AS SEPARATE ITEMS

0000AT0310A	Blue plastified bag 45 L, 33x24x63 cm	1 pc.
0000AT0310B	Red plastified bag 45 L, 33x24x63 cm	1 pc.
P2909962U	Pedal set for Alpha trolleys with long base or compact, closed bag holder 150 L and wheels ø 125 mm	1 pc.
P320100UA	EQUODOSE - dosing device with one tank 6 L for mop soaking on demand	1 pc.

### ON REQUEST, WITH SURCHARGE

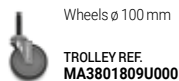

### ALPHASPLIT MR3806814 - plastic trolley

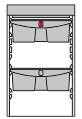

REF.	PCK	VOLUME (m³)	GROSS WEIGHT (kg)	SIZE (cm)
<b>MR3806814U000</b>	1	0,596	49,5	146x58x117
0000SE0204UA	Grey plastic bucket 4 L with blue upper plastic handle	1 pc.		
0000SE0204UB	Grey plastic bucket 4 L with red upper plastic handle	1 pc.		
0000SE0204UC	Grey plastic bucket 4 L with yellow upper plastic handle	1 pc.		
0000SE0204UF	Grey plastic bucket 4 L with green upper plastic handle	1 pc.		
0000SE1322A	TOP-DOWN® - blue plastic bucket 20 L with plastic handle and hermetic cover	1 pc.		
0000SM00165	Set of T-shaped light grey closing plugs for vertical frames (6 pcs)	2 pc.		
0000SM00617	Quick connection kit Link-Up to fix Alpha vertical frames	1 pc.		
3048	Set of 3 stickers for buckets	1 pc.		
P025061U	Compact base with wheels ø 125 mm	1 pc.		
P059061U	Short base with wheels ø 125 mm	1 pc.		
P1229906U	Grey plastic sliding drawer drawer 22 L without locking key	1 pc.		
P165001U	Plastic extension for Alpha base	1 pc.		
P1909937U	Plastic lift for buckets, with holes for bottles, fitting drawers 22 and 40 L	1 pc.		
P1909968U	Covering for bag holder 150L, foldable bag holder 120L and closing profiles	1 pc.		
P2039903E	Vertical frame, 1 side with slides + 1 side for T-plugs, complete with screws and plugs	2 pc.		
P2039906E	Vertical Frame, 1 smooth side + 1 side for T-plugs, complete with screws and plugs	1 pc.		
P2059963E	Door for AlphaSplit bag holder	1 pc.		
P2229906U	Plastic sliding drawer 22 L with lock	1 pc.		
P2229913U	Sliding plastic drawer 33L with lock for AlphaSplit	1 pc.		
P2229914U	Plastic shelf for AlphaSplit	1 pc.		
P2909912U	Divider for bag holder 150 L	1 pc.		
P2909920U	Closing profile for central basket/bag holder complete with screws and plugs	1 pc.		
P2909921U	Closing profile with push-grip for central basket complete with screws and plugs	1 pc.		
P2909946A	Blue cover for bag holder 150 L with check list holder	1 pc.		
P3059953E	Fixed side wall with fixing pins	1 pc.		
P3059954E	Right door with fixing pins	1 pc.		
P3059967E	Set right and left walls for AlphaSplit	1 pc.		
P3199903U	Central ring for 4l buckets complete with lockable grey lid and 2 pistons	1 pc.		
P8169905U	150l waste bag holder for Alpha standard and 90l for AlphaSplit, male fitting, with hooks, pistons, screws and plugs	1 pc.		

### ACCESSORIES TO ORDER AS SEPARATE ITEMS

0000AT0310A	Blue plastified bag 45 L, 33x24x63 cm	1 pc.
0000AT0310B	Red plastified bag 45 L, 33x24x63 cm	1 pc.
P320100UA	EQUODOSE - dosing device with one tank 6 L for mop soaking on demand	1 pc.
P3909962U	Pedal set for trolleys with short base, bag holder 150 L and wheels ø 125 mm	1 pc.

### ON REQUEST, WITH SURCHARGE

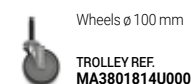



ALPHA

MORGAN

CHROMED AND RILSAN COATED TROLLEYS

## Link-Up Line

### ALPHASPLIT 0706855 - plastic trolley



REF.	PCK	VOLUME (m³)	GROSS WEIGHT (kg)	SIZE (cm)
<b>MA0706855U000</b>	1	0,372	24,45	94x58x120
0000SE0204UA	Grey plastic bucket 4 L with blue upper plastic handle	1 pc.		
0000SE0204UB	Grey plastic bucket 4 L with red upper plastic handle	1 pc.		
0000SE1322A	TOP-DOWN® - blue plastic bucket 20 L with plastic handle and hermetic cover	1 pc.		
0000SM00165	Set of T-shaped light grey closing plugs for vertical frames (6 pcs)	1 pc.		
I1050072	Stainless steel holder for buckets 4 L for bag holder 150 L	1 pc.		
P059061U	Short base with wheels ø 125 mm	1 pc.		
P165001U	Plastic extension for Alpha base	1 pc.		
P1909968U	Covering for bag holder 150L, foldable bag holder 120L and closing profiles	1 pc.		
P2039906E	Vertical Frame, 1 smooth side + 1 side for T-plugs, complete with screws and plugs	1 pc.		
P2059963E	Door for AlphaSplit bag holder	1 pc.		
P2229913U	Sliding plastic drawer 33L with lock for AlphaSplit	1 pc.		
P2229914U	Plastic shelf for AlphaSplit	1 pc.		
P2909912U	Divider for bag holder 150 L	1 pc.		
P2909946A	Blue cover for bag holder 150 L with check list holder	1 pc.		
P3059967E	Set right and left walls for AlphaSplit	1 pc.		
P8269907U	150l waste bag holder for Alpha standard and 90l for AlphaSplit, with adjustable push handle, male fitting, with hooks, pistons, screws and plugs	1 pc.		

### ACCESSORIES TO ORDER AS SEPARATE ITEMS

0000AT0310A	Blue plastified bag 45 L, 33x24x63 cm	1 pc.
P320100UA	EQUODOSE - dosing device with one tank 6 L for mop soaking on demand	1 pc.
P3909962U	Pedal set for trolleys with short base, bag holder 150 L and wheels ø 125 mm	1 pc.

### ON REQUEST, WITH SURCHARGE

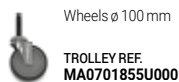

### ALPHA MR0601400 - plastic trolley with Link-Up system

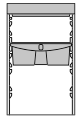

REF.	PCK	VOLUME (m³)	GROSS WEIGHT (kg)	SIZE (cm)
<b>MR0601400U017</b>	1	0,549	40,76	153x68x114
0000SE0104A	Blue plastic bucket 4 L with plastic handle	1 pc.		
0000SE0104B	Red plastic bucket 4 L with plastic handle	1 pc.		
0000SE0104C	Yellow plastic bucket 4 L with plastic handle	1 pc.		
0000SE0104F	Green plastic bucket 4 L with plastic handle	1 pc.		
0000SM00165	Set of T-shaped light grey closing plugs for vertical frames (6 pcs)	2 pc.		
0000SM00617	Quick connection kit Link-Up to fix Alpha vertical frames	1 pc.		
3048	Set of 3 stickers for buckets	1 pc.		
7004A	REGULAR - blue plastic down-press wringer with plastic gears	1 pc.		
8108A	Blue plastic bucket 15 L with plastic handle	1 pc.		
8108B	Red plastic bucket 15 L with plastic handle	1 pc.		
P025011U	Compact base with wheels ø 100 mm	1 pc.		
P066011U	Long base with wheels ø 100 mm	1 pc.		
P1229906U	Grey plastic sliding drawer 22 L without locking key	1 pc.		
P1909967U	Closing profile for bag holder 120 L	1 pc.		
P2031103U	Vertical frame with reinforcement, 1 smooth side + 1 side for T-plugs, complete with screws	1 pc.		
P2039903E	Vertical frame, 1 side with slides + 1 side for T-plugs, complete with screws and plugs	2 pc.		
P2199906U	Central plastic basket (female-female version) complete with caps	1 pc.		
P2909920U	Closing profile for central basket/bag holder complete with screws and plugs	1 pc.		
P2909921U	Closing profile with push-grip for central basket complete with screws and plugs	1 pc.		
P3059953E	Fixed side wall with fixing pins	1 pc.		
P3059954E	Right door with fixing pins	1 pc.		
P8161111U	120l waste bag holder, male fitting, with dustpan hook and handle clip	1 pc.		
R1040010	Rilsan coated wringer support complete with screws	1 pc.		

### ACCESSORIES TO ORDER AS SEPARATE ITEMS

3650A	Blue plastified bag 73x97,5 cm, capacity 120 L	1 pc.
P291918A	Blue cover for bag holder 120 L	1 pc.

### ON REQUEST, WITH SURCHARGE

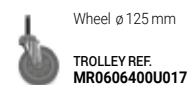



# Multipurpose trolleys



## ALPHA

## MORGAN

## CHROMED AND RILSAN COATED TROLLEYS

### ALPHA MR3801400 - plastic trolley with Link-Up system

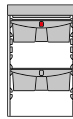

REF.	PCK	VOLUME (m³)	GROSS WEIGHT (kg)	SIZE (cm)
<b>MR3801400U000</b>	1	0,177	47,2	155x68x110
0000SE0204UA	Grey plastic bucket 4 L with blue upper plastic handle	1 pc.		
0000SE0204UB	Grey plastic bucket 4 L with red upper plastic handle	1 pc.		
0000SE0204UC	Grey plastic bucket 4 L with yellow upper plastic handle	1 pc.		
0000SE0204UF	Grey plastic bucket 4 L with green upper plastic handle	1 pc.		
0000SM00165	Set of T-shaped light grey closing plugs for vertical frames (6 pcs)	2 pc.		
0000SM00617	Quick connection kit Link-Up to fix Alpha vertical frames	1 pc.		
3048	Set of 3 stickers for buckets	1 pc.		
7004A	REGULAR - blue plastic down-press wringer with plastic gears	1 pc.		
8108A	Blue plastic bucket 15 L with plastic handle	1 pc.		
8108B	Red plastic bucket 15 L with plastic handle	1 pc.		
P025011U	Compact base with wheels ø 100 mm	1 pc.		
P066011U	Long base with wheels ø 100 mm	1 pc.		
P1229906U	Grey plastic sliding drawer 22 L without locking key	1 pc.		
P1909937U	Plastic lift for buckets, with holes for bottles, fitting drawers 22 and 40 L	1 pc.		
P1909968U	Covering for bag holder 150L, foldable bag holder 120L and closing profiles	1 pc.		
P2039903E	Vertical frame, 1 side with slides + 1 side for T-plugs, complete with screws and plugs	3 pcs		
P2229906U	Plastic sliding drawer 22 L with lock	1 pc.		
P2909912U	Divider for bag holder 150 L	1 pc.		
P2909920U	Closing profile for central basket/bag holder complete with screws and plugs	1 pc.		
P2909921U	Closing profile with push-grip for central basket complete with screws and plugs	1 pc.		
P2909946A	Blue cover for bag holder 150 L with check list holder	1 pc.		
P3059953E	Fixed side wall with fixing pins	3 pcs		
P3059954E	Right door with fixing pins	1 pc.		
P3199903U	Central ring for 4l buckets complete with lockable grey lid and 2 pistons	1 pc.		
P3909952E	Door with fixing pins for bag holder	1 pc.		
P8169905U	150l waste bag holder for Alpha standard and 90l for AlphaSplit, male fitting, with hooks, pistons, screws and plugs	1 pc.		
R1040010	Rilsan coated wringer support complete with screws	1 pc.		

### ACCESSORIES TO ORDER AS SEPARATE ITEMS

0000AT0160A	Blue plastic-coated bag 57x98 cm, maximum capacity 80 L	1 pc.
0000AT0160B	Red plastic-coated bag 57x98 cm, capacity 80 L	1 pc.
P2909915U	Pedal set for Alpha trolleys with long base or compact, closed bag holder 150 L and wheels ø 100 mm	1 pc.

### ON REQUEST, WITH SURCHARGE

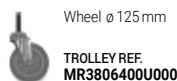

### ALPHA MR3606701 - plastic trolley with Link-Up system

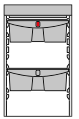

REF.	PCK	GROSS WEIGHT (kg)	SIZE (cm)
<b>MR3606701U000</b>	1	39,89	146x58x112
0000SE0204UA	Grey plastic bucket 4 L with blue upper plastic handle	1 pc.	
0000SE0204UB	Grey plastic bucket 4 L with red upper plastic handle	1 pc.	
0000SE0204UC	Grey plastic bucket 4 L with yellow upper plastic handle	1 pc.	
0000SE0204UF	Grey plastic bucket 4 L with green upper plastic handle	1 pc.	
0000SE1322A	TOP-DOWN® - blue plastic bucket 20 L with plastic handle and hermetic cover	1 pc.	
0000SE1322B	TOP-DOWN® - red plastic bucket 20 L with plastic handle and hermetic cover	1 pc.	
0000SM00165	Set of T-shaped light grey closing plugs for vertical frames (6 pcs)	2 pc.	
0000SM00617	Quick connection kit Link-Up to fix Alpha vertical frames	1 pc.	
3048	Set of 3 stickers for buckets	1 pc.	
P025061U	Compact base with wheels ø 125 mm	1 pc.	
P059061U	Short base with wheels ø 125 mm	1 pc.	
P1191100U	Side plastic basket	1 pc.	
P1229906U	Grey plastic sliding drawer 22 L without locking key	1 pc.	
P165001U	Plastic extension for Alpha base	1 pc.	
P1909937U	Plastic lift for buckets, with holes for bottles, fitting drawers 22 and 40 L	1 pc.	
P1909967U	Closing profile for bag holder 120 L	1 pc.	
P2031103U	Vertical frame with reinforcement, 1 smooth side+ 1 side for T-plugs, complete with screws	1 pc.	
P2039903E	Vertical frame, 1 side with slides + 1 side for T-plugs, complete with screws and plugs	2 pc.	
P206030U	1x40 L + 1x80 L plastic divider for plastic bag holder 120 L	1 pc.	
P2229906U	Plastic sliding drawer 22 L with lock	1 pc.	
P2909920U	Closing profile for central basket/bag holder complete with screws and plugs	1 pc.	
P2909921U	Closing profile with push-grip for central basket complete with screws and plugs	1 pc.	
P3059953E	Fixed side wall with fixing pins	1 pc.	
P3059954E	Right door with fixing pins	1 pc.	
P3199903U	Central ring for 4l buckets complete with lockable grey lid and 2 pistons	1 pc.	
P8161111U	120l waste bag holder, male fitting, with dustpan hook and handle clip	1 pc.	

### ACCESSORIES TO ORDER AS SEPARATE ITEMS

0000AT0160A	Blue plastic-coated bag 57x98 cm, maximum capacity 80 L	1 pc.
0000AT0170B	Red plastic-coated bag 48x95 cm, maximum capacity 60 L	1 pc.
P291918A	Blue cover for bag holder 120 L	1 pc.

### ON REQUEST, WITH SURCHARGE





## ALPHA

## MORGAN

## CHROMED AND RILSAN COATED TROLLEYS

### ALPHA MR0806703 - plastic trolley with Link-Up system

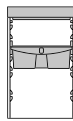

### ALPHASPLIT MR3806814 - plastic trolley

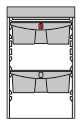

REF.	PCK	GROSS WEIGHT (kg)	SIZE (cm)
<b>MR0806703U000</b>	1	45,5	146x58x117

0000SE0104A	Blue plastic bucket 4 L with plastic handle	1 pc.
0000SE0104B	Red plastic bucket 4 L with plastic handle	1 pc.
0000SE0104C	Yellow plastic bucket 4 L with plastic handle	1 pc.
0000SE0104F	Green plastic bucket 4 L with plastic handle	1 pc.
0000SE1322A	TOP-DOWN® - blue plastic bucket 20 L with plastic handle and hermetic cover	1 pc.
0000SE1322B	TOP-DOWN® - red plastic bucket 20 L with plastic handle and hermetic cover	1 pc.
0000SM00165	Set of T-shaped light grey closing plugs for vertical frames (6 pcs)	2 pc.
0000SM00617	Quick connection kit Link-Up to fix Alpha vertical frames	1 pc.
3048	Set of 3 stickers for buckets	1 pc.
P025061U	Compact base with wheels ø 125 mm	1 pc.
P059061U	Short base with wheels ø 125 mm	1 pc.
P1191100U	Side plastic basket	1 pc.
P1229906U	Grey plastic sliding drawer drawer 22 L without locking key	1 pc.
P165001U	Plastic extension for Alpha base	1 pc.
P1909968U	Covering for bag holder 150L, foldable bag holder 120L and closing profiles	1 pc.
P2039903E	Vertical frame, 1 side with slides + 1 side for T-plugs, complete with screws and plugs	3 pcs
P2199906U	Central plastic basket (female-female version) complete with caps	1 pc.
P2909912U	Divider for bag holder 150 L	1 pc.
P2909920U	Closing profile for central basket/bag holder complete with screws and plugs	1 pc.
P2909921U	Closing profile with push-grip for central basket complete with screws and plugs	1 pc.
P2909946A	Blue cover for bag holder 150 L with check list holder	1 pc.
P3059953E	Fixed side wall with fixing pins	3 pcs
P3059954E	Right door with fixing pins	1 pc.
P3909952E	Door with fixing pins for bag holder	1 pc.
P8169905U	150l waste bag holder for Alpha standard and 90l for AlphaSplit, male fitting, with hooks, pistons, screws and plugs	1 pc.

#### ACCESSORIES TO ORDER AS SEPARATE ITEMS

0000AT0160A	Blue plastic-coated bag 57x98 cm, maximum capacity 80 L	1 pc.
0000AT0160B	Red plastified bag 57x98 cm, capacity 80 L	1 pc.
P2909962U	Pedal set for Alpha trolleys with long base or compact, closed bag holder 150 L and wheels ø 125 mm	1 pc.

#### ON REQUEST, WITH SURCHARGE

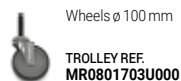

REF.	PCK	VOLUME (m³)	GROSS WEIGHT (kg)	SIZE (cm)
<b>MR3806814U000</b>	1	0,596	49,5	146x58x117

0000SE0204UA	Grey plastic bucket 4 L with blue upper plastic handle	1 pc.
0000SE0204UB	Grey plastic bucket 4 L with red upper plastic handle	1 pc.
0000SE0204UC	Grey plastic bucket 4 L with yellow upper plastic handle	1 pc.
0000SE0204UF	Grey plastic bucket 4 L with green upper plastic handle	1 pc.
0000SE1322A	TOP-DOWN® - blue plastic bucket 20 L with plastic handle and hermetic cover	1 pc.
0000SM00165	Set of T-shaped light grey closing plugs for vertical frames (6 pcs)	2 pc.
0000SM00617	Quick connection kit Link-Up to fix Alpha vertical frames	1 pc.
3048	Set of 3 stickers for buckets	1 pc.
P025061U	Compact base with wheels ø 125 mm	1 pc.
P059061U	Short base with wheels ø 125 mm	1 pc.
P1229906U	Grey plastic sliding drawer drawer 22 L without locking key	1 pc.
P165001U	Plastic extension for Alpha base	1 pc.
P1909937U	Plastic lift for buckets, with holes for bottles, fitting drawers 22 and 40 L	1 pc.
P1909968U	Covering for bag holder 150L, foldable bag holder 120L and closing profiles	1 pc.
P2039903E	Vertical frame, 1 side with slides + 1 side for T-plugs, complete with screws and plugs	2 pc.
P2039906E	Vertical Frame, 1 smooth side + 1 side for T-plugs, complete with screws and plugs	1 pc.
P2059963E	Door for AlphaSplit bag holder	1 pc.
P2229906U	Plastic sliding drawer 22 L with lock	1 pc.
P2229913U	Sliding plastic drawer 33L with lock for AlphaSplit	1 pc.
P2229914U	Plastic shelf for AlphaSplit	1 pc.
P2909912U	Divider for bag holder 150 L	1 pc.
P2909920U	Closing profile for central basket/bag holder complete with screws and plugs	1 pc.
P2909921U	Closing profile with push-grip for central basket complete with screws and plugs	1 pc.
P2909946A	Blue cover for bag holder 150 L with check list holder	1 pc.
P3059953E	Fixed side wall with fixing pins	1 pc.
P3059954E	Right door with fixing pins	1 pc.
P3059967E	Set right and left walls for AlphaSplit	1 pc.
P3199903U	Central ring for 4l buckets complete with lockable grey lid and 2 pistons	1 pc.
P8169905U	150l waste bag holder for Alpha standard and 90l for AlphaSplit, male fitting, with hooks, pistons, screws and plugs	1 pc.

#### ACCESSORIES TO ORDER AS SEPARATE ITEMS

0000AT0310A	Blue plastified bag 45 L, 33x24x63 cm	1 pc.
0000AT0310B	Red plastified bag 45 L, 33x24x63 cm	1 pc.
P320100UA	EQUODOSE - dosing device with one tank 6 L for mop soaking on demand	1 pc.
P3909962U	Pedal set for trolleys with short base, bag holder 150 L and wheels ø 125 mm	1 pc.

#### ON REQUEST, WITH SURCHARGE

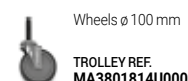

# Multipurpose trolleys



ALPHA

MORGAN

CHROMED AND RILSAN COATED TROLLEYS

## General Line

### ALPHA 0101003 - plastic trolley



### ALPHA 1100 - plastic trolley



REF.	PCK	VOLUME (m³)	GROSS WEIGHT (kg)	SIZE (cm) ↓ ↓ ↓
<b>MA0101003U000</b>	1	0,177	13,66	75x58x102
0000SM00163	Set of T-shaped dark grey closing plugs for vertical frames (6 pcs)			1 pc.
0000SM00639	Uni-Move 2 handle holder kit			1 pc.
P059011U	Short base with wheels ø 100 mm			1 pc.
P1191100U	Side plastic basket			4 pcs
P1901112U	Plastic rising support for basket art. P1191100U			2 pc.
P2031102U	Vertical frame with reinforcement, 2 sides with T-plugs, complete with screws			1 pc.
P2909960U	Closing profile for vertical frame complete with screws and plugs			1 pc.

REF.	PCK	VOLUME (m³)	GROSS WEIGHT (kg)	SIZE (cm) ↓ ↓ ↓
<b>0000MA1100U00</b>	1	0,177	13,01	75x58x102
0000SM00163	Set of T-shaped dark grey closing plugs for vertical frames (6 pcs)			1 pc.
P059011U	Short base with wheels ø 100 mm			1 pc.
P1191100U	Side plastic basket			2 pc.
P1909967U	Closing profile for bag holder 120 L			1 pc.
P2031103U	Vertical frame with reinforcement, 1 smooth side + 1 side for T-plugs, complete with screws			1 pc.
P8161111U	120L waste bag holder, male fitting, with dustpan hook and handle clip			1 pc.

#### ON REQUEST, WITH SURCHARGE

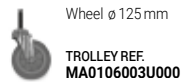

#### ACCESSORIES TO ORDER AS SEPARATE ITEMS

3650A	Blue plastified bag 73x97,5 cm, capacity 120 L	1 pc.
P291918A	Blue cover for bag holder 120 L	1 pc.

#### ON REQUEST, WITH SURCHARGE

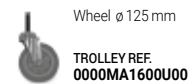



## ALPHA

## MORGAN

## CHROMED AND RILSAN COATED TROLLEYS

### ALPHA 1101 - plastic trolley



### ALPHA 2101 - plastic trolley



REF.	PCK	VOLUME (m³)	GROSS WEIGHT (kg)	SIZE (cm) ↓ ↓ ↓
------	-----	-------------	-------------------	--------------------

<b>0000MA1101U00</b>	1	0,177	13,11	75x58x111
0000SE0104A	Blue plastic bucket 4 L with plastic handle	1 pc.		
0000SE0104B	Red plastic bucket 4 L with plastic handle	1 pc.		
0000SM00163	Set of T-shaped dark grey closing plugs for vertical frames (6 pcs)	1 pc.		
P059011U	Short base with wheels ø 100 mm	1 pc.		
P1191100U	Side plastic basket	1 pc.		
P2031103U	Vertical frame with reinforcement, 1 smooth side + 1 side for T-plugs, complete with screws	1 pc.		
P8161112U	120L waste bag holder with tray, hooks, screws and plugs	1 pc.		

#### ACCESSORIES TO ORDER AS SEPARATE ITEMS

3650A	Blue plastified bag 73x97,5 cm, capacity 120 L	1 pc.
P291918A	Blue cover for bag holder 120 L	1 pc.

#### ON REQUEST, WITH SURCHARGE

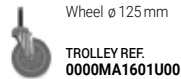

REF.	PCK	VOLUME (m³)	GROSS WEIGHT (kg)	SIZE (cm) ↓ ↓ ↓
------	-----	-------------	-------------------	--------------------

<b>0000MA2101U00</b>	1	0,261	20,25	126x58x102
0000SM00165	Set of T-shaped light grey closing plugs for vertical frames (6 pcs)	2 pc.		
P059011U	Short base with wheels ø 100 mm	1 pc.		
P1229906U	Grey plastic sliding drawer 22 L without locking key	1 pc.		
P165000U	Base extension for Alpha trolleys and for the bag supporting plastic plate of the Morgan Hotel Elegance trolleys	1 pc.		
P175000U	Supporting plastic plate for Alpha trolleys	1 pc.		
P2039903E	Vertical frame, 1 side with slides + 1 side for T-plugs, complete with screws and plugs	2 pc.		
P2199906U	Central plastic basket (female-female version) complete with caps	1 pc.		
P8161111U	120L waste bag holder, male fitting, with dustpan hook and handle clip	2 pc.		

#### ACCESSORIES TO ORDER AS SEPARATE ITEMS

3650A	Blue plastified bag 73x97,5 cm, capacity 120 L	1 pc.
3650B	Red plastified bag 73x97,5 cm, capacity 120 L	1 pc.
P291918A	Blue cover for bag holder 120 L	1 pc.
P291918B	Red cover for bag holder 120 L	1 pc.

#### ON REQUEST, WITH SURCHARGE

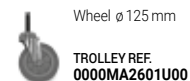

# Multipurpose trolleys



## ALPHA

## MORGAN

## CHROMED AND RILSAN COATED TROLLEYS

### ALPHA 0001003 - plastic trolley



### ALPHA 2103-14 - plastic trolley



REF.	PCK	VOLUME (m³)	GROSS WEIGHT (kg)	SIZE (cm) ↓ ↓ ↓
<b>MA0001003U000</b>	1	0,372	20,87	55x55x101
0000SM00165	Set of T-shaped light grey closing plugs for vertical frames (6 pcs)			2 pc.
0000SM00639	Uni-Move 2 handle holder kit			1 pc.
P025011U	Compact base with wheels ø 100 mm			1 pc.
P2039903E	Vertical frame, 1 side with slides + 1 side for T-plugs, complete with screws and plugs			2 pc.
P2199906U	Central plastic basket (female-female version) complete with caps			1 pc.
P2229906U	Plastic sliding drawer 22 L with lock			2 pc.
P2229907U	Plastic sliding drawer 40 L with locking key			1 pc.
P2909920U	Closing profile for central basket/bag holder complete with screws and plugs			1 pc.
P2909921U	Closing profile with push-grip for central basket complete with screws and plugs			1 pc.

REF.	PCK	VOLUME (m³)	GROSS WEIGHT (kg)	SIZE (cm) ↓ ↓ ↓
<b>0000MA2103U14</b>	1	0,372	20,27	81x55x101
0000SM00165	Set of T-shaped light grey closing plugs for vertical frames (6 pcs)			2 pc.
0000SM00639	Uni-Move 2 handle holder kit			1 pc.
P059011U	Short base with wheels ø 100 mm			1 pc.
P1191100U	Side plastic basket			2 pc.
P1199900U	Upper basket			1 pc.
P2039903E	Vertical frame, 1 side with slides + 1 side for T-plugs, complete with screws and plugs			2 pc.
P2199907U	Central plastic basket (male-female version) complete with screws and caps			1 pc.
P2229906U	Plastic sliding drawer 22 L with lock			2 pc.
P2229907U	Plastic sliding drawer 40 L with locking key			1 pc.
P2909921U	Closing profile with push-grip for central basket complete with screws and plugs			1 pc.

#### ON REQUEST, WITH SURCHARGE

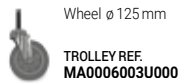

#### ON REQUEST, WITH SURCHARGE

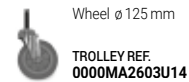



## ALPHA

## MORGAN

## CHROMED AND RILSAN COATED TROLLEYS

### ALPHA 3301000 - plastic trolley

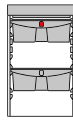
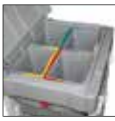

REF.	PCK	VOLUME (m³)	GROSS WEIGHT (kg)	SIZE (cm)
<b>MA3301000U000</b>	1	0,27	25,47	97x58x110
0000SE0204UA	Grey plastic bucket 4 L with blue upper plastic handle	1 pc.		
0000SE0204UB	Grey plastic bucket 4 L with red upper plastic handle	1 pc.		
0000SE0204UC	Grey plastic bucket 4 L with yellow upper plastic handle	1 pc.		
0000SE0204UF	Grey plastic bucket 4 L with green upper plastic handle	1 pc.		
0000SM00165	Set of T-shaped light grey closing plugs for vertical frames (6 pcs)	2 pc.		
3048	Set of 3 stickers for buckets	1 pc.		
P059011U	Short base with wheels ø 100 mm	1 pc.		
P1229906U	Grey plastic sliding drawer 22 L without locking key	1 pc.		
P165000U	Base extension for Alpha trolleys and for the bag supporting plastic plate of the Morgan Hotel Elegance trolleys	1 pc.		
P1909937U	Plastic lift for buckets, with holes for bottles, fitting drawers 22 and 40 L	1 pc.		
P2039903E	Vertical frame, 1 side with slides + 1 side for T-plugs, complete with screws and plugs	2 pc.		
P2229906U	Plastic sliding drawer 22 L with lock	1 pc.		
P2909920U	Closing profile for central basket/bag holder complete with screws and plugs	1 pc.		
P3059953E	Fixed side wall with fixing pins	1 pc.		
P3059954E	Right door with fixing pins	1 pc.		
P3199903U	Central ring for 4l buckets complete with lockable grey lid and 2 pistons	1 pc.		
P8161115U	Folding 120l waste bag holder with deep fitting, with bag retaining hooks, dustpan hook, handle clip, screws and plugs	1 pc.		

### ACCESSORIES TO ORDER AS SEPARATE ITEMS

3650A	Blue plastified bag 73x97,5 cm, capacity 120 L	1 pc.
P291918A	Blue cover for bag holder 120 L	1 pc.

### ON REQUEST, WITH SURCHARGE

	Rubber wheels ø 125 mm	TROLLEY REF. <b>MA3303000U000</b>
	Wheel ø 125 mm	TROLLEY REF. <b>MA3306000U000</b>

### ALPHA 0301002 - plastic trolley



REF.	PCK	VOLUME (m³)	GROSS WEIGHT (kg)	SIZE (cm)
<b>MA0301002U000</b>	1	0,224	19,31	58x81x102
0000SM00165	Set of T-shaped light grey closing plugs for vertical frames (6 pcs)	1 pc.		
P059011U	Short base with wheels ø 100 mm	1 pc.		
P1191100U	Side plastic basket	1 pc.		
P1199900U	Upper basket	1 pc.		
P2039903E	Vertical frame, 1 side with slides + 1 side for T-plugs, complete with screws and plugs	1 pc.		
P2909912U	Divider for bag holder 150 L	1 pc.		
P2909946A	Blue cover for bag holder 150 L with check list holder	1 pc.		
P3059953E	Fixed side wall with fixing pins	2 pc.		
P3909952E	Door with fixing pins for bag holder	1 pc.		
P8169905U	150l waste bag holder for Alpha standard and 90l for AlphaSplit, male fitting, with hooks, pistons, screws and plugs	1 pc.		

### ACCESSORIES TO ORDER AS SEPARATE ITEMS

0000AT0160A	Blue plastic-coated bag 57x98 cm, maximum capacity 80 L	1 pc.
0000AT0160B	Red plastified bag 57x98 cm, capacity 80 L	1 pc.
P3909915U	Pedal set for Alpha trolleys with short base, bag holder 150 L and wheels ø 100 mm	1 pc.

### ON REQUEST, WITH SURCHARGE

	Rubber wheels ø 125 mm	TROLLEY REF. <b>MA0303002U000</b>
	Wheel ø 125 mm	TROLLEY REF. <b>MA0306002U000</b>
	Bag holder with adjustable push-grip	TROLLEY REF. <b>MA0301052U000</b>

# Multipurpose trolleys



## ALPHA

## MORGAN

## CHROMED AND RILSAN COATED TROLLEYS

### ALPHA 4101 - plastic trolley



### ALPHA 5100-14 - plastic trolley



REF.	PCK	VOLUME (m³)	GROSS WEIGHT (kg)	SIZE (cm) ↓ ↓ ↓
<b>0000MA4101U00</b>	1	0,177	14,91	92x58x111

0000SE0104A	Blue plastic bucket 4 L with plastic handle	1 pc.
0000SE0104B	Red plastic bucket 4 L with plastic handle	1 pc.
0000SM00163	Set of T-shaped dark grey closing plugs for vertical frames (6 pcs)	1 pc.
P066011U	Long base with wheels ø 100 mm	1 pc.
P1191100U	Side plastic basket	1 pc.
P2031103U	Vertical frame with reinforcement, 1 smooth side + 1 side for T-plugs, complete with screws	1 pc.
P8161112U	120l waste bag holder with tray, hooks, screws and plugs	1 pc.

#### ACCESSORIES TO ORDER AS SEPARATE ITEMS

3650A	Blue plastified bag 73x97,5 cm, capacity 120 L	1 pc.
P291918A	Blue cover for bag holder 120 L	1 pc.

#### ON REQUEST, WITH SURCHARGE

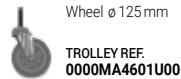

REF.	PCK	VOLUME (m³)	GROSS WEIGHT (kg)	SIZE (cm) ↓ ↓ ↓
<b>0000MA5100U14</b>	1	0,372	20,77	92x58x102

0000SM00165	Set of T-shaped light grey closing plugs for vertical frames (6 pcs)	2 pc.
P066011U	Long base with wheels ø 100 mm	1 pc.
P2039903E	Vertical frame, 1 side with slides + 1 side for T-plugs, complete with screws and plugs	2 pc.
P2199906U	Central plastic basket (female-female version) complete with caps	1 pc.
P2229906U	Plastic sliding drawer 22 L with lock	2 pc.
P2229907U	Plastic sliding drawer 40 L with locking key	1 pc.
P2909920U	Closing profile for central basket/bag holder complete with screws and plugs	1 pc.
P8161111U	120l waste bag holder, male fitting, with dustpan hook and handle clip	1 pc.

#### ACCESSORIES TO ORDER AS SEPARATE ITEMS

3650A	Blue plastified bag 73x97,5 cm, capacity 120 L	1 pc.
P291918A	Blue cover for bag holder 120 L	1 pc.

#### ON REQUEST, WITH SURCHARGE

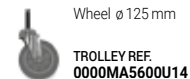



## ALPHA

## MORGAN

## CHROMED AND RILSAN COATED TROLLEYS

### ALPHA 5101 - plastic trolley



### ALPHA 0501006 - plastic trolley



REF.	PCK	VOLUME (m³)	GROSS WEIGHT (kg)	SIZE (cm) ↓ ↓ ↓
<b>0000MA5101U00</b>	1	0,261	18,05	92x58x114
0000SE0104A	Blue plastic bucket 4 L with plastic handle	1 pc.		
0000SE0104B	Red plastic bucket 4 L with plastic handle	1 pc.		
0000SE0104C	Yellow plastic bucket 4 L with plastic handle	1 pc.		
0000SE0104F	Green plastic bucket 4 L with plastic handle	1 pc.		
0000SM00165	Set of T-shaped light grey closing plugs for vertical frames (6 pcs)	2 pc.		
3048	Set of 3 stickers for buckets	1 pc.		
P066011U	Long base with wheels ø 100 mm	1 pc.		
P1229906U	Grey plastic sliding drawer drawer 22 L without locking key	1 pc.		
P2039903E	Vertical frame, 1 side with slides + 1 side for T-plugs, complete with screws and plugs	2 pc.		
P2199906U	Central plastic basket (female-female version) complete with caps	1 pc.		
P2909920U	Closing profile for central basket/bag holder complete with screws and plugs	1 pc.		
P8161111U	120l waste bag holder, male fitting, with dustpan hook and handle clip	1 pc.		

#### ACCESSORIES TO ORDER AS SEPARATE ITEMS

3650A	Blue plastified bag 73x97,5 cm, capacity 120 L	1 pc.
P291918A	Blue cover for bag holder 120 L	1 pc.

#### ON REQUEST, WITH SURCHARGE

	Rubber wheels ø 125 mm	
	Wheel ø 125 mm	
	<b>TROLLEY REF. 0000MA5301U00</b>	
	<b>TROLLEY REF. 0000MA5601U00</b>	

REF.	PCK	VOLUME (m³)	GROSS WEIGHT (kg)	SIZE (cm) ↓ ↓ ↓
<b>MA0501006U000</b>	1	0,372	22,97	98x58x114
0000SE0104A	Blue plastic bucket 4 L with plastic handle	1 pc.		
0000SE0104B	Red plastic bucket 4 L with plastic handle	1 pc.		
0000SE0104C	Yellow plastic bucket 4 L with plastic handle	1 pc.		
0000SE0104F	Green plastic bucket 4 L with plastic handle	1 pc.		
0000SM00165	Set of T-shaped light grey closing plugs for vertical frames (6 pcs)	2 pc.		
0000SM00610	Assembling kit to fix Handy bin to Alpha vertical frame	1 pc.		
0000SM00639	Uni-Move 2 handle holder kit	1 pc.		
3048	Set of 3 stickers for buckets	1 pc.		
P066011U	Long base with wheels ø 100 mm	1 pc.		
P1229906U	Grey plastic sliding drawer drawer 22 L without locking key	1 pc.		
P2039903E	Vertical frame, 1 side with slides + 1 side for T-plugs, complete with screws and plugs	2 pc.		
P2199906U	Central plastic basket (female-female version) complete with caps	1 pc.		
P2909920U	Closing profile for central basket/bag holder complete with screws and plugs	1 pc.		
P2909921U	Closing profile with push-grip for central basket complete with screws and plugs	1 pc.		
P291070E	HANDY - bin 70 L with drain plug, wheels and bag stretcher	1 pc.		

#### ON REQUEST, WITH SURCHARGE

	Rubber wheels ø 125 mm	
	Wheel ø 125 mm	
	<b>TROLLEY REF. MA0503006U000</b>	
	<b>TROLLEY REF. MA0506006U000</b>	



# Multipurpose trolleys



## ALPHA

## MORGAN

## CHROMED AND RILSAN COATED TROLLEYS

### ALPHA 5113-01 - plastic trolley



### ALPHA 6105 - plastic trolley



REF.	PCK	VOLUME (m³)	GROSS WEIGHT (kg)	SIZE (cm) ↓ ↓ ↓
<b>0000MA5113U01</b>	1	0,261	21,45	104x55x101

0000SM00165	Set of T-shaped light grey closing plugs for vertical frames (6 pcs)	2 pc.
0000SM00639	Uni-Move 2 handle holder kit	1 pc.
P066011U	Long base with wheels ø 100 mm	1 pc.
P1229906U	Grey plastic sliding drawer 22 L without locking key	2 pc.
P2039903E	Vertical frame, 1 side with slides + 1 side for T-plugs, complete with screws and plugs	2 pc.
P2039904E	Vertical frame, 2 sides with slides, complete with screws and plugs	1 pc.
P2199906U	Central plastic basket (female-female version) complete with caps	1 pc.
P2199907U	Central plastic basket (male-female version) complete with screws and caps	1 pc.
P2909921U	Closing profile with push-grip for central basket complete with screws and plugs	2 pc.

#### ON REQUEST, WITH SURCHARGE

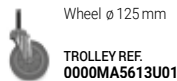

REF.	PCK	VOLUME (m³)	GROSS WEIGHT (kg)	SIZE (cm) ↓ ↓ ↓
<b>0000MA6105U00</b>	1	0,261	22,05	133x58x102

0000SM00165	Set of T-shaped light grey closing plugs for vertical frames (6 pcs)	2 pc.
P066011U	Long base with wheels ø 100 mm	1 pc.
P1229906U	Grey plastic sliding drawer 22 L without locking key	1 pc.
P175000U	Supporting plastic plate for Alpha trolleys	1 pc.
P2039903E	Vertical frame, 1 side with slides + 1 side for T-plugs, complete with screws and plugs	2 pc.
P2199906U	Central plastic basket (female-female version) complete with caps	1 pc.
P3059953E	Fixed side wall with fixing pins	1 pc.
P3059954E	Right door with fixing pins	1 pc.
P8161111U	120L waste bag holder, male fitting, with dustpan hook and handle clip	2 pc.

#### ACCESSORIES TO ORDER AS SEPARATE ITEMS

3650A	Blue plastified bag 73x97,5 cm, capacity 120 L	1 pc.
3650B	Red plastified bag 73x97,5 cm, capacity 120 L	1 pc.
P291918A	Blue cover for bag holder 120 L	1 pc.
P291918B	Red cover for bag holder 120 L	1 pc.

#### ON REQUEST, WITH SURCHARGE

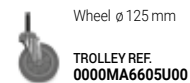



## ALPHA

## MORGAN

## CHROMED AND RILSAN COATED TROLLEYS

### ALPHA 8100 - plastic trolley

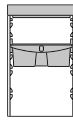

### ALPHA 3801000 - plastic trolley

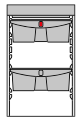
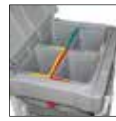

REF.	PCK	VOLUME (m <sup>3</sup> )	GROSS WEIGHT (kg)	SIZE (cm)
<b>2000MA8100U00</b>	1	0,372	24,37	98x58x102

0000SM00165	Set of T-shaped light grey closing plugs for vertical frames (6 pcs)	2 pc.
P066011U	Long base with wheels ø 100 mm	1 pc.
P1229906U	Grey plastic sliding drawer drawer 22 L without locking key	1 pc.
P2039903E	Vertical frame, 1 side with slides + 1 side for T-plugs, complete with screws and plugs	2 pc.
P2199906U	Central plastic basket (female-female version) complete with caps	1 pc.
P2909912U	Divider for bag holder 150 L	1 pc.
P2909920U	Closing profile for central basket/bag holder complete with screws and plugs	1 pc.
P2909946A	Blue cover for bag holder 150 L with check list holder	1 pc.
P3059953E	Fixed side wall with fixing pins	3 pcs
P3059954E	Right door with fixing pins	1 pc.
P3909952E	Door with fixing pins for bag holder	1 pc.
P8169905U	150L waste bag holder for Alpha standard and 90l for AlphaSplit, male fitting, with hooks, pistons, screws and plugs	1 pc.

#### ACCESSORIES TO ORDER AS SEPARATE ITEMS

0000AT0160A	Blue plastic-coated bag 57x98 cm, maximum capacity 80 L	1 pc.
0000AT0160B	Red plastified bag 57x98 cm, capacity 80 L	1 pc.
P2909915U	Pedal set for Alpha trolleys with long base or compact, closed bag holder 150 L and wheels ø 100 mm	1 pc.

#### ON REQUEST, WITH SURCHARGE

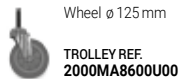

REF.	PCK	VOLUME (m <sup>3</sup> )	GROSS WEIGHT (kg)	SIZE (cm)
<b>MA3801000U001</b>	1	0,372	29,47	124x58x110

0000SE0204UA	Grey plastic bucket 4 L with blue upper plastic handle	1 pc.
0000SE0204UB	Grey plastic bucket 4 L with red upper plastic handle	1 pc.
0000SE0204UC	Grey plastic bucket 4 L with yellow upper plastic handle	1 pc.
0000SE0204UF	Grey plastic bucket 4 L with green upper plastic handle	1 pc.
0000SM00165	Set of T-shaped light grey closing plugs for vertical frames (6 pcs)	2 pc.
3048	Set of 3 stickers for buckets	1 pc.
P066011U	Long base with wheels ø 100 mm	1 pc.
P1191100U	Side plastic basket	2 pc.
P1229906U	Grey plastic sliding drawer drawer 22 L without locking key	1 pc.
P1909937U	Plastic lift for buckets, with holes for bottles, fitting drawers 22 and 40 L	1 pc.
P2039903E	Vertical frame, 1 side with slides + 1 side for T-plugs, complete with screws and plugs	2 pc.
P2229906U	Plastic sliding drawer 22 L with lock	1 pc.
P2909912U	Divider for bag holder 150 L	1 pc.
P2909920U	Closing profile for central basket/bag holder complete with screws and plugs	1 pc.
P2909946A	Blue cover for bag holder 150 L with check list holder	1 pc.
P3059953E	Fixed side wall with fixing pins	3 pcs
P3059954E	Right door with fixing pins	1 pc.
P3199903U	Central ring for 4l buckets complete with lockable grey lid and 2 pistons	1 pc.
P3909952E	Door with fixing pins for bag holder	1 pc.
P8169905U	150L waste bag holder for Alpha standard and 90l for AlphaSplit, male fitting, with hooks, pistons, screws and plugs	1 pc.

#### ACCESSORIES TO ORDER AS SEPARATE ITEMS

0000AT0160A	Blue plastic-coated bag 57x98 cm, maximum capacity 80 L	1 pc.
0000AT0160B	Red plastified bag 57x98 cm, capacity 80 L	1 pc.
P2909915U	Pedal set for Alpha trolleys with long base or compact, closed bag holder 150 L and wheels ø 100 mm	1 pc.

#### ON REQUEST, WITH SURCHARGE

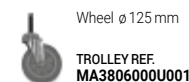

# Multipurpose trolleys



ALPHA

MORGAN

CHROMED AND RILSAN COATED TROLLEYS

## ALPHA 0601019 - plastic trolley

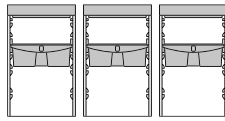

REF.	PCK	VOLUME (m <sup>3</sup> )	GROSS WEIGHT (kg)	SIZE (cm)
<b>MA0601019U000</b>	1	0,488	35,24	146x58x101
0000SM00165	Set of T-shaped light grey closing plugs for vertical frames (6 pcs)			2 pc.
0000SM00639	Uni-Move 2 handle holder kit			1 pc.
P066011U	Long base with wheels ø 100 mm			1 pc.
P1229906U	Grey plastic sliding drawer 22 L without locking key			3 pcs
P2039903E	Vertical frame, 1 side with slides + 1 side for T-plugs, complete with screws and plugs			2 pc.
P2039904E	Vertical frame, 2 sides with slides, complete with screws and plugs			2 pc.
P2199906U	Central plastic basket (female-female version) complete with caps			1 pc.
P2199907U	Central plastic basket (male-female version) complete with screws and caps			2 pc.
P2909921U	Closing profile with push-grip for central basket complete with screws and plugs			2 pc.
P3059953E	Fixed side wall with fixing pins			3 pcs
P3059954E	Right door with fixing pins			2 pc.
P3059974E	Left door with fixing pins			1 pc.
P515010U	Supporting plastic plate with 2 wheels ø 100 mm and 2 blocking clips			1 pc.

### ON REQUEST, WITH SURCHARGE

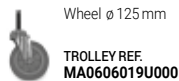



ALPHA

MORGAN

CHROMED AND RILSAN COATED TROLLEYS

## Wet Mopping Line

### ALPHA 1104 - plastic trolley



### ALPHA 1105 - plastic trolley



REF.	PCK	VOLUME (m³)	GROSS WEIGHT (kg)	SIZE (cm) ↓ ↓ ↓
<b>0000MA1104U00</b>	1	0,261	19,04	97x68x111
0000SE0104A	Blue plastic bucket 4 L with plastic handle	1 pc.		
0000SE0104B	Red plastic bucket 4 L with plastic handle	1 pc.		
0000SM00163	Set of T-shaped dark grey closing plugs for vertical frames (6 pcs)	1 pc.		
7004A	REGULAR - blue plastic down-press wringer with plastic gears	1 pc.		
8108A	Blue plastic bucket 15 L with plastic handle	1 pc.		
8108B	Red plastic bucket 15 L with plastic handle	1 pc.		
P059011U	Short base with wheels ø 100 mm	1 pc.		
P165000U	Base extension for Alpha trolleys and for the bag supporting plastic plate of the Morgan Hotel Elegance trolleys	1 pc.		
P2031103U	Vertical frame with reinforcement, 1 smooth side + 1 side for T-plugs, complete with screws	1 pc.		
P8161112U	120l waste bag holder with tray, hooks, screws and plugs	1 pc.		
R1040010	Rilsan coated wringer support complete with screws	1 pc.		

#### ACCESSORIES TO ORDER AS SEPARATE ITEMS

3650A	Blue plastified bag 73x97,5 cm, capacity 120 L	1 pc.
P291918A	Blue cover for bag holder 120 L	1 pc.

#### ON REQUEST, WITH SURCHARGE

	Rubber wheels ø 125 mm TROLLEY REF. <b>0000MA1304U00</b>		Wheel ø 125 mm TROLLEY REF. <b>0000MA1604U00</b>		Foldable bag holder 120 L TROLLEY REF. <b>0300MA1104U00</b>
--	---	--	---	--	--

REF.	PCK	VOLUME (m³)	GROSS WEIGHT (kg)	SIZE (cm) ↓ ↓ ↓
<b>0000MA1105U00</b>	1	0,322	22,02	97x58x111
0000SE0104A	Blue plastic bucket 4 L with plastic handle	1 pc.		
0000SE0104B	Red plastic bucket 4 L with plastic handle	1 pc.		
0000SL2700C	JUMPY - single shockproof plastic bucket 30 L	1 pc.		
0000SM00163	Set of T-shaped dark grey closing plugs for vertical frames (6 pcs)	1 pc.		
P059011U	Short base with wheels ø 100 mm	1 pc.		
P165000U	Base extension for Alpha trolleys and for the bag supporting plastic plate of the Morgan Hotel Elegance trolleys	1 pc.		
P2031103U	Vertical frame with reinforcement, 1 smooth side + 1 side for T-plugs, complete with screws	1 pc.		
P8161112U	120l waste bag holder with tray, hooks, screws and plugs	1 pc.		

#### ACCESSORIES TO ORDER AS SEPARATE ITEMS

3650A	Blue plastified bag 73x97,5 cm, capacity 120 L	1 pc.
P291918A	Blue cover for bag holder 120 L	1 pc.

#### ON REQUEST, WITH SURCHARGE

	Rubber wheels ø 125 mm TROLLEY REF. <b>0000MA1305U00</b>		Wheel ø 125 mm TROLLEY REF. <b>0000MA1605U00</b>		Foldable bag holder 120 L TROLLEY REF. <b>0300MA1105U00</b>
--	---	--	---	--	--

# Multipurpose trolleys



## ALPHA

## MORGAN

## CHROMED AND RILSAN COATED TROLLEYS

### ALPHA 0101405 - plastic trolley

**NEW**



### ALPHA 0001000 - plastic trolley

**NEW**



REF.	PCK	VOLUME (m³)	GROSS WEIGHT (kg)	SIZE (cm) ↓ ↓ ↓
<b>MA0101405U000</b>	1	0,261	17,25	83x56x111
0000SE0104A	Blue plastic bucket 4 L with plastic handle	1 pc.		
0000SE0104B	Red plastic bucket 4 L with plastic handle	1 pc.		
0000SM00163	Set of T-shaped dark grey closing plugs for vertical frames (6 pcs)	1 pc.		
0020SE2742U	Kit Duo Pro - 25l mop bucket, 17l mop bucket, Duo Pro lever-operated wringer, extension for base and 2 spacers	1 pc.		
P059011U	Short base with wheels ø 100 mm	1 pc.		
P1199900U	Upper basket	1 pc.		
P2031102U	Vertical frame with reinforcement, 2 sides with T-plugs, complete with screws	1 pc.		
P2909921U	Closing profile with push-grip for central basket complete with screws and plugs	1 pc.		
R2060031	Rilsan 70l waste bag holder	1 pc.		

#### ACCESSORIES TO ORDER AS SEPARATE ITEMS

0000AT0160A	Blue plastic-coated bag 57x98 cm, maximum capacity 80 L	1 pc.
P190916A	Plastic lid for 70l waste bag holder	1 pc.

#### ON REQUEST, WITH SURCHARGE

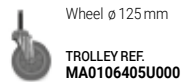

REF.	PCK	VOLUME (m³)	GROSS WEIGHT (kg)	SIZE (cm) ↓ ↓ ↓
<b>MA0001000U000</b>	1	0,177	12,91	55x55x102

#### Complete trolley sizes with OneFred 122x65x102 cm

0000SM00163	Set of T-shaped dark grey closing plugs for vertical frames (6 pcs)	1 pc.
P025011U	Compact base with wheels ø 100 mm	1 pc.
P1909967U	Closing profile for bag holder 120 L	1 pc.
P2031103U	Vertical frame with reinforcement, 1 smooth side + 1 side for T-plugs, complete with screws	1 pc.
P8161111U	120l waste bag holder, male fitting, with dustpan hook and handle clip	1 pc.

#### ACCESSORIES TO ORDER AS SEPARATE ITEMS

0000LF0031YU	ONEFRED - 30 l plastic trolley with plastic handle, tray and broom holder	1 pc.
0000SM00301	PEG KIT - OneFred attachment kit for Alpha trolleys	1 pc.
3650A	Blue plastified bag 73x97,5 cm, capacity 120 L	1 pc.
P291918A	Blue cover for bag holder 120 L	1 pc.

#### ON REQUEST, WITH SURCHARGE

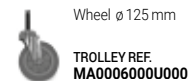



## ALPHA

## MORGAN

## CHROMED AND RILSAN COATED TROLLEYS

### ALPHA 4103 - plastic trolley



### ALPHA 0401403 - plastic trolley

**NEW**



REF.	PCK	VOLUME (m³)	GROSS WEIGHT (kg)	SIZE (cm) ↓ ↓ ↓
<b>0000MA4103U00</b>	1	0,261	18,64	92x68x111
0000SE0104A	Blue plastic bucket 4 L with plastic handle	1 pc.		
0000SE0104B	Red plastic bucket 4 L with plastic handle	1 pc.		
0000SM00163	Set of T-shaped dark grey closing plugs for vertical frames (6 pcs)	1 pc.		
7004A	REGULAR - blue plastic down-press wringer with plastic gears	1 pc.		
8108A	Blue plastic bucket 15 L with plastic handle	1 pc.		
8108B	Red plastic bucket 15 L with plastic handle	1 pc.		
P066011U	Long base with wheels ø 100 mm	1 pc.		
P2031103U	Vertical frame with reinforcement, 1 smooth side + 1 side for T-plugs, complete with screws	1 pc.		
P8161112U	120l waste bag holder with tray, hooks, screws and plugs	1 pc.		
R1040010	Rilsan coated wringer support complete with screws	1 pc.		

REF.	PCK	VOLUME (m³)	GROSS WEIGHT (kg)	SIZE (cm) ↓ ↓ ↓
<b>MA0401403U000</b>	1	0,261	17,99	95x56x111
0000SE0104A	Blue plastic bucket 4 L with plastic handle	1 pc.		
0000SE0104B	Red plastic bucket 4 L with plastic handle	1 pc.		
0000SM00163	Set of T-shaped dark grey closing plugs for vertical frames (6 pcs)	1 pc.		
0020SE2742U	Kit Duo Pro - 25l mop bucket, 17l mop bucket, Duo Pro lever-operated wringer, extension for base and 2 spacers	1 pc.		
P066011U	Long base with wheels ø 100 mm	1 pc.		
P2031103U	Vertical frame with reinforcement, 1 smooth side + 1 side for T-plugs, complete with screws	1 pc.		
P8161112U	120l waste bag holder with tray, hooks, screws and plugs	1 pc.		

#### ACCESSORIES TO ORDER AS SEPARATE ITEMS

3650A	Blue plastified bag 73x97,5 cm, capacity 120 L	1 pc.
P291918A	Blue cover for bag holder 120 L	1 pc.

#### ACCESSORIES TO ORDER AS SEPARATE ITEMS

3650A	Blue plastified bag 73x97,5 cm, capacity 120 L	1 pc.
P291918A	Blue cover for bag holder 120 L	1 pc.

#### ON REQUEST, WITH SURCHARGE

	Rubber wheels ø 125 mm <b>TROLLEY REF. 0000MA4303U00</b>		Wheel ø 125 mm <b>TROLLEY REF. 0000MA4603U00</b>
--	---	---	---

#### ON REQUEST, WITH SURCHARGE

	Rubber wheels ø 125 mm <b>TROLLEY REF. MA0403403U000</b>		Wheel ø 125 mm <b>TROLLEY REF. MA0406403U000</b>
---	---	---	---

# Multipurpose trolleys



## ALPHA

## MORGAN

## CHROMED AND RILSAN COATED TROLLEYS

### ALPHA 0401402 - plastic trolley



### ALPHA 5107- plastic trolley



REF.	PCK	VOLUME (m³)	GROSS WEIGHT (kg)	SIZE (cm) ↓ ↓ ↓
<b>MA0401402U000</b>	1	0,372	23,45	102x68x111
0000SE0104A	Blue plastic bucket 4 L with plastic handle	1 pc.		
0000SE0104B	Red plastic bucket 4 L with plastic handle	1 pc.		
0000SM00163	Set of T-shaped dark grey closing plugs for vertical frames (6 pcs)	2 pc.		
0000SM00610	Assembling kit to fix Handy bin to Alpha vertical frame	1 pc.		
0000SM00639	Uni-Move 2 handle holder kit	1 pc.		
7004A	REGULAR - blue plastic down-press wringer with plastic gears	1 pc.		
8108A	Blue plastic bucket 15 L with plastic handle	1 pc.		
8108B	Red plastic bucket 15 L with plastic handle	1 pc.		
P066011U	Long base with wheels ø 100 mm	1 pc.		
P1199900U	Upper basket	1 pc.		
P2031102U	Vertical frame with reinforcement, 2 sides with T-plugs, complete with screws	1 pc.		
P2909920U	Closing profile for central basket/bag holder complete with screws and plugs	1 pc.		
P391070E	HANDY - bin 70 L with drain plug, wheels, bag stretcher and grip	1 pc.		
R1040010	Rilsan coated wringer support complete with screws	1 pc.		

REF.	PCK	VOLUME (m³)	GROSS WEIGHT (kg)	SIZE (cm) ↓ ↓ ↓
<b>0000MA5107U00</b>	1	0,372	25,46	133x68x120
0000SM00165	Set of T-shaped light grey closing plugs for vertical frames (6 pcs)	2 pc.		
7004A	REGULAR - blue plastic down-press wringer with plastic gears	1 pc.		
8108A	Blue plastic bucket 15 L with plastic handle	1 pc.		
8108B	Red plastic bucket 15 L with plastic handle	1 pc.		
8211/1A	Blue plastic bucket 12 L with plastic handle	1 pc.		
8211/1B	Red plastic bucket 12 L with plastic handle	1 pc.		
P066011U	Long base with wheels ø 100 mm	1 pc.		
P1229906U	Grey plastic sliding drawer drawer 22 L without locking key	1 pc.		
P175000U	Supporting plastic plate for Alpha trolleys	1 pc.		
P2039903E	Vertical frame, 1 side with slides + 1 side for T-plugs, complete with screws and plugs	2 pc.		
P2199906U	Central plastic basket (female-female version) complete with caps	1 pc.		
P2909920U	Closing profile for central basket/bag holder complete with screws and plugs	1 pc.		
P8161111U	120L waste bag holder, male fitting, with dustpan hook and handle clip	1 pc.		
R1040010	Rilsan coated wringer support complete with screws	1 pc.		

### ON REQUEST, WITH SURCHARGE

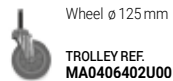

### ACCESSORIES TO ORDER AS SEPARATE ITEMS

3650A	Blue plastified bag 73x97,5 cm, capacity 120 L	1 pc.
P291918A	Blue cover for bag holder 120 L	1 pc.

### ON REQUEST, WITH SURCHARGE

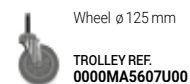



## ALPHA

## MORGAN

## CHROMED AND RILSAN COATED TROLLEYS

### ALPHA 5108-18 - plastic trolley



### ALPHA 0501414 - plastic trolley

**NEW**



REF.	PCK	VOLUME (m³)	GROSS WEIGHT (kg)	SIZE (cm) ↓ ↓ ↓
<b>0000MA5108U18</b>	1	0,372	27,46	133x68x114
0000SE0104A	Blue plastic bucket 4 L with plastic handle	1 pc.		
0000SE0104B	Red plastic bucket 4 L with plastic handle	1 pc.		
0000SE0104C	Yellow plastic bucket 4 L with plastic handle	1 pc.		
0000SE0104F	Green plastic bucket 4 L with plastic handle	1 pc.		
0000SM00165	Set of T-shaped light grey closing plugs for vertical frames (6 pcs)	2 pc.		
3048	Set of 3 stickers for buckets	1 pc.		
7004A	REGULAR - blue plastic down-press wringer with plastic gears	1 pc.		
8108A	Blue plastic bucket 15 L with plastic handle	1 pc.		
8108B	Red plastic bucket 15 L with plastic handle	1 pc.		
P066011U	Long base with wheels ø 100 mm	1 pc.		
P1229906U	Grey plastic sliding drawer drawer 22 L without locking key	1 pc.		
P175000U	Supporting plastic plate for Alpha trolleys	1 pc.		
P2039903E	Vertical frame, 1 side with slides + 1 side for T-plugs, complete with screws and plugs	2 pc.		
P2199906U	Central plastic basket (female-female version) complete with caps	1 pc.		
P2229907U	Plastic sliding drawer 40 L with locking key	1 pc.		
P2909920U	Closing profile for central basket/bag holder complete with screws and plugs	1 pc.		
P8161111U	120l waste bag holder, male fitting, with dustpan hook and handle clip	1 pc.		
R1040010	Rilsan coated wringer support complete with screws	1 pc.		

REF.	PCK	VOLUME (m³)	GROSS WEIGHT (kg)	SIZE (cm) ↓ ↓ ↓
<b>MA0501414U000</b>	1	0,372	23,59	139x56x114
0000SE0104A	Blue plastic bucket 4 L with plastic handle	1 pc.		
0000SE0104B	Red plastic bucket 4 L with plastic handle	1 pc.		
0000SE0104C	Yellow plastic bucket 4 L with plastic handle	1 pc.		
0000SE0104F	Green plastic bucket 4 L with plastic handle	1 pc.		
0000SM00165	Set of T-shaped light grey closing plugs for vertical frames (6 pcs)	2 pc.		
0020SE2742U	Kit Duo Pro - 25l mop bucket, 17l mop bucket, Duo Pro lever-operated wringer, extension for base and 2 spacers	1 pc.		
3048	Set of 3 stickers for buckets	1 pc.		
P066011U	Long base with wheels ø 100 mm	1 pc.		
P1229906U	Grey plastic sliding drawer drawer 22 L without locking key	1 pc.		
P175000U	Supporting plastic plate for Alpha trolleys	1 pc.		
P2039903E	Vertical frame, 1 side with slides + 1 side for T-plugs, complete with screws and plugs	2 pc.		
P2199906U	Central plastic basket (female-female version) complete with caps	1 pc.		
P2229907U	Plastic sliding drawer 40 L with locking key	1 pc.		
P2909920U	Closing profile for central basket/bag holder complete with screws and plugs	1 pc.		
P8161111U	120l waste bag holder, male fitting, with dustpan hook and handle clip	1 pc.		

### ACCESSORIES TO ORDER AS SEPARATE ITEMS

3650A	Blue plastified bag 73x97,5 cm, capacity 120 L	1 pc.
P291918A	Blue cover for bag holder 120 L	1 pc.

### ACCESSORIES TO ORDER AS SEPARATE ITEMS

3650A	Blue plastified bag 73x97,5 cm, capacity 120 L	1 pc.
P291918A	Blue cover for bag holder 120 L	1 pc.

### ON REQUEST, WITH SURCHARGE

	Rubber wheels ø 125 mm TROLLEY REF. <b>0000MA5308U18</b>		Wheel ø 125 mm TROLLEY REF. <b>0000MA5608U18</b>		Foldable bag holder 120 L TROLLEY REF. <b>0300MA5108U00</b>
--	---	--	---	--	--

### ON REQUEST, WITH SURCHARGE

	Rubber wheels ø 125 mm TROLLEY REF. <b>MA0503414U000</b>		Wheel ø 125 mm TROLLEY REF. <b>MA0506414U000</b>		Foldable bag holder 120 L TROLLEY REF. <b>MA0501414U001</b>
--	---	--	---	--	--



# Multipurpose trolleys



## ALPHA

## MORGAN

## CHROMED AND RILSAN COATED TROLLEYS

### ALPHA 0201000 - plastic trolley

**NEW**



### ALPHA 5109 - plastic trolley



REF.	PCK	VOLUME (m³)	GROSS WEIGHT (kg)	SIZE (cm) ↓ ↓ ↓
MA0201000U000	1	0,261	18,81	97x58x114

#### Complete trolley sizes with OneFred 160x65x114 cm

0000SE0104A	Blue plastic bucket 4 L with plastic handle	1 pc.
0000SE0104B	Red plastic bucket 4 L with plastic handle	1 pc.
0000SE0104C	Yellow plastic bucket 4 L with plastic handle	1 pc.
0000SE0104F	Green plastic bucket 4 L with plastic handle	1 pc.
0000SM00165	Set of T-shaped light grey closing plugs for vertical frames (6 pcs)	2 pc.
3048	Set of 3 stickers for buckets	1 pc.
P059011U	Short base with wheels ø 100 mm	1 pc.
P1229906U	Grey plastic sliding drawer drawer 22 L without locking key	1 pc.
P165000U	Base extension for Alpha trolleys and for the bag supporting plastic plate of the Morgan Hotel Elegance trolleys	1 pc.
P2039903E	Vertical frame, 1 side with slides + 1 side for T-plugs, complete with screws and plugs	2 pc.
P2199906U	Central plastic basket (female-female version) complete with caps	1 pc.
P2909920U	Closing profile for central basket/bag holder complete with screws and plugs	1 pc.
P8161113U	Folding 120l waste bag holder, with bag retaining hooks, dustpan hook, handle clip, screws and plugs	1 pc.

#### ACCESSORIES TO ORDER AS SEPARATE ITEMS

0000LF0031YU	ONEFRED - 30 l plastic trolley with plastic handle, tray and broom holder	1 pc.
0000SM00301	PEG KIT - OneFred attachment kit for Alpha trolleys	1 pc.
3650A	Blue plastified bag 73x97,5 cm, capacity 120 L	1 pc.
P291918A	Blue cover for bag holder 120 L	1 pc.

#### ON REQUEST, WITH SURCHARGE

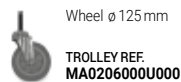

REF.	PCK	VOLUME (m³)	GROSS WEIGHT (kg)	SIZE (cm) ↓ ↓ ↓
0000MA5109U00	1	0,372	25,86	133x68x114

0000SE0104A	Blue plastic bucket 4 L with plastic handle	1 pc.
0000SE0104B	Red plastic bucket 4 L with plastic handle	1 pc.
0000SE0104C	Yellow plastic bucket 4 L with plastic handle	1 pc.
0000SE0104F	Green plastic bucket 4 L with plastic handle	1 pc.
0000SM00165	Set of T-shaped light grey closing plugs for vertical frames (6 pcs)	2 pc.
3048	Set of 3 stickers for buckets	1 pc.
7004A	REGULAR - blue plastic down-press wringer with plastic gears	1 pc.
8108A	Blue plastic bucket 15 L with plastic handle	1 pc.
8108B	Red plastic bucket 15 L with plastic handle	1 pc.
P066011U	Long base with wheels ø 100 mm	1 pc.
P1199900U	Upper basket	1 pc.
P1229906U	Grey plastic sliding drawer drawer 22 L without locking key	1 pc.
P175000U	Alpha trolley supporting plate	1 pc.
P2039903E	Vertical frame, 1 side with slides + 1 side for T-plugs, complete with screws and plugs	2 pc.
P2199907U	Central plastic basket (male-female version) complete with screws and caps	1 pc.
P8161111U	120l waste bag holder, male fitting, with dustpan hook and handle clip	1 pc.
R1040010	Rilsan coated wringer support complete with screws	1 pc.

#### ACCESSORIES TO ORDER AS SEPARATE ITEMS

3650A	Blue plastified bag 73x97,5 cm, capacity 120 L	1 pc.
P291918A	Blue cover for bag holder 120 L	1 pc.

#### ON REQUEST, WITH SURCHARGE

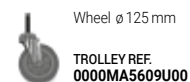



## ALPHA

## MORGAN

## CHROMED AND RILSAN COATED TROLLEYS

### ALPHA 5110 - plastic trolley



### ALPHA 0601000 - plastic trolley



REF.	PCK	VOLUME (m <sup>3</sup> )	GROSS WEIGHT (kg)	SIZE (cm) ↓ ↓ ↓
<b>0000MA5110U00</b>	1	0,4	28,62	133x69x114

0000SE0104A	Blue plastic bucket 4 L with plastic handle	1 pc.
0000SE0104B	Red plastic bucket 4 L with plastic handle	1 pc.
0000SE0104C	Yellow plastic bucket 4 L with plastic handle	1 pc.
0000SE0104F	Green plastic bucket 4 L with plastic handle	1 pc.
0000SM00165	Set of T-shaped light grey closing plugs for vertical frames (6 pcs)	2 pc.
0000SM00606	Rilsan coated fixing set for Fred trolley	1 pc.
3048	Set of 3 stickers for buckets	1 pc.
7960A/P	FRED - plastic trolley 30 L with plastic grip	1 pc.
P066011U	Long base with wheels ø 100 mm	1 pc.
P1229906U	Grey plastic sliding drawer drawer 22 L without locking key	1 pc.
P175000U	Alpha trolley supporting plate	1 pc.
P2039903E	Vertical frame, 1 side with slides + 1 side for T-plugs, complete with screws and plugs	2 pc.
P2199906U	Central plastic basket (female-female version) complete with caps	1 pc.
P2909920U	Closing profile for central basket/bag holder complete with screws and plugs	1 pc.
P8161111U	120l waste bag holder, male fitting, with dustpan hook and handle clip	1 pc.

#### ACCESSORIES TO ORDER AS SEPARATE ITEMS

3650A	Blue plastified bag 73x97,5 cm, capacity 120 L	1 pc.
P291918A	Blue cover for bag holder 120 L	1 pc.

#### ON REQUEST, WITH SURCHARGE

	Rubber wheels ø 125 mm		Wheel ø 125 mm		Foldable bag holder 120 L
	<b>TROLLEY REF. 0000MA5310U00</b>		<b>TROLLEY REF. 0000MA5610U00</b>		<b>TROLLEY REF. 0300MA5110U00</b>

REF.	PCK	VOLUME (m <sup>3</sup> )	GROSS WEIGHT (kg)	SIZE (cm) ↓ ↓ ↓
<b>MA0601000U000</b>	1	0,261	26,55	92x58x114

#### Complete trolley sizes with OneFred 155x65x114 cm

0000SE0104A	Blue plastic bucket 4 L with plastic handle	1 pc.
0000SE0104B	Red plastic bucket 4 L with plastic handle	1 pc.
0000SE0104C	Yellow plastic bucket 4 L with plastic handle	1 pc.
0000SE0104F	Green plastic bucket 4 L with plastic handle	1 pc.
0000SM00165	Set of T-shaped light grey closing plugs for vertical frames (6 pcs)	2 pc.
3048	Set of 3 stickers for buckets	1 pc.
P066011U	Long base with wheels ø 100 mm	1 pc.
P1229906U	Grey plastic sliding drawer drawer 22 L without locking key	1 pc.
P2039903E	Vertical frame, 1 side with slides + 1 side for T-plugs, complete with screws and plugs	2 pc.
P2199906U	Central plastic basket (female-female version) complete with caps	1 pc.
P2909920U	Closing profile for central basket/bag holder complete with screws and plugs	1 pc.
P3059953E	Fixed side wall with fixing pins	1 pc.
P3059954E	Right door with fixing pins	1 pc.
P8161111U	120l waste bag holder, male fitting, with dustpan hook and handle clip	1 pc.

#### ACCESSORIES TO ORDER AS SEPARATE ITEMS

0000LF0030YU	ONEFRED - 30 l plastic trolley with plastic handle	1 pc.
0000SM00298	PEG KIT - OneFred attachment kit for Alpha trolleys with broom holder	1 pc.
3650A	Blue plastified bag 73x97,5 cm, capacity 120 L	1 pc.
P291918A	Blue cover for bag holder 120 L	1 pc.

#### ON REQUEST, WITH SURCHARGE

	Rubber wheels ø 125 mm		Wheel ø 125 mm
	<b>TROLLEY REF. MA0603000U000</b>		<b>TROLLEY REF. MA0606000U000</b>

# Multipurpose trolleys



## ALPHA

## MORGAN

## CHROMED AND RILSAN COATED TROLLEYS

### ALPHA 6103 - plastic trolley

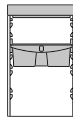

### ALPHA 3601400 - plastic trolley

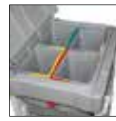



REF.	PCK	VOLUME (m <sup>3</sup> )	GROSS WEIGHT (kg)	SIZE (cm)
<b>0000MA6103U00</b>	1	0,372	28,06	133x68x114
0000SE0104A	Blue plastic bucket 4 L with plastic handle	1 pc.		
0000SE0104B	Red plastic bucket 4 L with plastic handle	1 pc.		
0000SE0104C	Yellow plastic bucket 4 L with plastic handle	1 pc.		
0000SE0104F	Green plastic bucket 4 L with plastic handle	1 pc.		
0000SM00165	Set of T-shaped light grey closing plugs for vertical frames (6 pcs)	2 pc.		
3048	Set of 3 stickers for buckets	1 pc.		
7004A	REGULAR - blue plastic down-press wringer with plastic gears	1 pc.		
8108A	Blue plastic bucket 15 L with plastic handle	1 pc.		
8108B	Red plastic bucket 15 L with plastic handle	1 pc.		
P066011U	Long base with wheels ø 100 mm	1 pc.		
P1199900U	Upper basket	1 pc.		
P1229906U	Grey plastic sliding drawer drawer 22 L without locking key	1 pc.		
P175000U	Supporting plastic plate for Alpha trolleys	1 pc.		
P2039903E	Vertical frame, 1 side with slides + 1 side for T-plugs, complete with screws and plugs	2 pc.		
P2199907U	Central plastic basket (male-female version) complete with screws and caps	1 pc.		
P3059953E	Fixed side wall with fixing pins	1 pc.		
P3059954E	Right door with fixing pins	1 pc.		
P8161111U	120l waste bag holder, male fitting, with dustpan hook and handle clip	1 pc.		
R1040010	Rilsan coated wringer support complete with screws	1 pc.		

#### ACCESSORIES TO ORDER AS SEPARATE ITEMS

3650A	Blue plastified bag 73x97,5 cm, capacity 120 L	1 pc.
P291918A	Blue cover for bag holder 120 L	1 pc.

#### ON REQUEST, WITH SURCHARGE

	Rubber wheels ø 125 mm	TROLLEY REF. <b>0000MA6303U00</b>
	Wheel ø 125 mm	TROLLEY REF. <b>0000MA6603U00</b>
	Foldable bag holder 120 L	TROLLEY REF. <b>0300MA6103U00</b>

REF.	PCK	VOLUME (m <sup>3</sup> )	GROSS WEIGHT (kg)	SIZE (cm)
<b>MA3601400U000</b>	1	0,372	30,37	133x68x110
0000SE0204UA	Grey plastic bucket 4 L with blue upper plastic handle	1 pc.		
0000SE0204UB	Grey plastic bucket 4 L with red upper plastic handle	1 pc.		
0000SE0204UC	Grey plastic bucket 4 L with yellow upper plastic handle	1 pc.		
0000SE0204UF	Grey plastic bucket 4 L with green upper plastic handle	1 pc.		
0000SM00165	Set of T-shaped light grey closing plugs for vertical frames (6 pcs)	2 pc.		
3048	Set of 3 stickers for buckets	1 pc.		
7004A	REGULAR - blue plastic down-press wringer with plastic gears	1 pc.		
8108A	Blue plastic bucket 15 L with plastic handle	1 pc.		
8108B	Red plastic bucket 15 L with plastic handle	1 pc.		
P066011U	Long base with wheels ø 100 mm	1 pc.		
P1229906U	Grey plastic sliding drawer drawer 22 L without locking key	1 pc.		
P175000U	Supporting plastic plate for Alpha trolleys	1 pc.		
P1909937U	Plastic lift for buckets, with holes for bottles, fitting drawers 22 and 40 L	1 pc.		
P2039903E	Vertical frame, 1 side with slides + 1 side for T-plugs, complete with screws and plugs	2 pc.		
P2229906U	Plastic sliding drawer 22 L with lock	1 pc.		
P2909920U	Closing profile for central basket/bag holder complete with screws and plugs	1 pc.		
P3059953E	Fixed side wall with fixing pins	1 pc.		
P3059954E	Right door with fixing pins	1 pc.		
P3199903U	Central ring for 4l buckets complete with lockable grey lid and 2 pistons	1 pc.		
P8161115U	Folding 120l waste bag holder with deep fitting, with bag retaining hooks, dustpan hook, handle clip, screws and plugs	1 pc.		
R1040010	Rilsan coated wringer support complete with screws	1 pc.		

#### ACCESSORIES TO ORDER AS SEPARATE ITEMS

3650A	Blue plastified bag 73x97,5 cm, capacity 120 L	1 pc.
P291918A	Blue cover for bag holder 120 L	1 pc.

#### ON REQUEST, WITH SURCHARGE

	Rubber wheels ø 125 mm	TROLLEY REF. <b>MA3603400U000</b>
	Wheel ø 125 mm	TROLLEY REF. <b>MA3606400U000</b>



## ALPHA

## MORGAN

## CHROMED AND RILSAN COATED TROLLEYS

### ALPHA 4601400 - plastic trolley

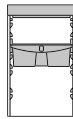

REF.	PCK	VOLUME (m³)	GROSS WEIGHT (kg)	SIZE (cm)
<b>MA4601400U000</b>	1	0,372	28,24	133x68x110
0000SE0108A	Blue plastic bucket 8 L with plastic handle	1 pc.		
0000SE0108B	Red plastic bucket 8 L with plastic handle	1 pc.		
0000SE0108C	Yellow plastic bucket 8 L with plastic handle	1 pc.		
0000SM00165	Set of T-shaped light grey closing plugs for vertical frames (6 pcs)	2 pc.		
7004A	REGULAR - blue plastic down-press wringer with plastic gears	1 pc.		
8108A	Blue plastic bucket 15 L with plastic handle	1 pc.		
8108B	Red plastic bucket 15 L with plastic handle	1 pc.		
P066011U	Long base with wheels ø 100 mm	1 pc.		
P1229906U	Grey plastic sliding drawer drawer 22 L without locking key	1 pc.		
P175000U	Supporting plastic plate for Alpha trolleys	1 pc.		
P2039903E	Vertical frame, 1 side with slides + 1 side for T-plugs, complete with screws and plugs	2 pc.		
P2909920U	Closing profile for central basket/bag holder complete with screws and plugs	1 pc.		
P3059953E	Fixed side wall with fixing pins	1 pc.		
P3059954E	Right door with fixing pins	1 pc.		
P3199905U	Central plastic frame with grey cover with locking key and 2 shock absorbing pistons for versions with 3 hanging buckets 8 L	1 pc.		
P8161115U	Folding 120l waste bag holder with deep fitting, with bag retaining hooks, dustpan hook, handle clip, screws and plugs	1 pc.		
R1040010	Rilsan coated wringer support complete with screws	1 pc.		

### ACCESSORIES TO ORDER AS SEPARATE ITEMS

3650A	Blue plastified bag 73x97,5 cm, capacity 120 L	1 pc.
P291918A	Blue cover for bag holder 120 L	1 pc.

### ON REQUEST, WITH SURCHARGE

	Rubber wheels ø 125 mm	TROLLEY REF. <b>MA4603400U000</b>
	Wheel ø 125 mm	TROLLEY REF. <b>MA4606400U000</b>

### ALPHA 7101 - plastic trolley



REF.	PCK	VOLUME (m³)	GROSS WEIGHT (kg)	SIZE (cm)
<b>2000MA7101U00</b>	1	0,372	22,46	98x68x111
0000SE0104A	Blue plastic bucket 4 L with plastic handle	1 pc.		
0000SE0104B	Red plastic bucket 4 L with plastic handle	1 pc.		
0000SM00165	Set of T-shaped light grey closing plugs for vertical frames (6 pcs)	1 pc.		
7004A	REGULAR - blue plastic down-press wringer with plastic gears	1 pc.		
8108A	Blue plastic bucket 15 L with plastic handle	1 pc.		
8108B	Red plastic bucket 15 L with plastic handle	1 pc.		
P066011U	Long base with wheels ø 100 mm	1 pc.		
P1199900U	Upper basket	1 pc.		
P2039903E	Vertical frame, 1 side with slides + 1 side for T-plugs, complete with screws and plugs	1 pc.		
P2909912U	Divider for bag holder 150 L	1 pc.		
P2909946A	Blue cover for bag holder 150 L with check list holder	1 pc.		
P3059953E	Fixed side wall with fixing pins	2 pc.		
P3909952E	Door with fixing pins for bag holder	1 pc.		
P8169905U	150l waste bag holder for Alpha standard and 90l for AlphaSplit, male fitting, with hooks, pistons, screws and plugs	1 pc.		
R1040010	Rilsan coated wringer support complete with screws	1 pc.		

### ACCESSORIES TO ORDER AS SEPARATE ITEMS

0000AT0160A	Blue plastic-coated bag 57x98 cm, maximum capacity 80 L	1 pc.
0000AT0160B	Red plastified bag 57x98 cm, capacity 80 L	1 pc.
P2909915U	Pedal set for Alpha trolleys with long base or compact, closed bag holder 150 L and wheels ø 100 mm	1 pc.

### ON REQUEST, WITH SURCHARGE

	Rubber wheels ø 125 mm	TROLLEY REF. <b>2000MA7301U00</b>
	Wheel ø 125 mm	TROLLEY REF. <b>2000MA7601U00</b>
	Bag holder with adjustable push-grip	TROLLEY REF. <b>MA0701450U000</b>

# Multipurpose trolleys



ALPHA

MORGAN

CHROMED AND RILSAN COATED TROLLEYS

## ALPHA 0701402 - plastic trolley

**NEW**



## ALPHA 8104 - plastic trolley



REF.	PCK	VOLUME (m³)	GROSS WEIGHT (kg)	SIZE (cm)
<b>MA0701402U000</b>	1	0,372	21,72	106x56x111

0000SE0104A	Blue plastic bucket 4 L with plastic handle	1 pc.
0000SE0104B	Red plastic bucket 4 L with plastic handle	1 pc.
0000SM00165	Set of T-shaped light grey closing plugs for vertical frames (6 pcs)	1 pc.
0020SE2742U	Kit Duo Pro - 25l mop bucket, 17l mop bucket, Duo Pro lever-operated wringer, extension for base and 2 spacers	1 pc.
P066011U	Long base with wheels ø 100 mm	1 pc.
P1199900U	Upper basket	1 pc.
P2039903E	Vertical frame, 1 side with slides + 1 side for T-plugs, complete with screws and plugs	1 pc.
P2909912U	Divider for bag holder 150 L	1 pc.
P2909946A	Blue cover for bag holder 150 L with check list holder	1 pc.
P3059953E	Fixed side wall with fixing pins	2 pc.
P3909952E	Door with fixing pins for bag holder	1 pc.
P8169905U	150l waste bag holder for Alpha standard and 90l for AlphaSplit, male fitting, with hooks, pistons, screws and plugs	1 pc.

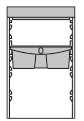

REF.	PCK	VOLUME (m³)	GROSS WEIGHT (kg)	SIZE (cm)
<b>1000MA8104U00</b>	1	0,406	34,64	139x68x114

0000SE0104A	Blue plastic bucket 4 L with plastic handle	1 pc.
0000SE0104B	Red plastic bucket 4 L with plastic handle	1 pc.
0000SE0104C	Yellow plastic bucket 4 L with plastic handle	1 pc.
0000SE0104F	Green plastic bucket 4 L with plastic handle	1 pc.
0000SM00165	Set of T-shaped light grey closing plugs for vertical frames (6 pcs)	2 pc.
3048	Set of 3 stickers for buckets	1 pc.
7004A	REGULAR - blue plastic down-press wringer with plastic gears	1 pc.
8108A	Blue plastic bucket 15 L with plastic handle	1 pc.
8108B	Red plastic bucket 15 L with plastic handle	1 pc.
P066011U	Long base with wheels ø 100 mm	1 pc.
P1229906U	Grey plastic sliding drawer drawer 22 L without locking key	1 pc.
P2039903E	Vertical frame, 1 side with slides + 1 side for T-plugs, complete with screws and plugs	2 pc.
P2199906U	Central plastic basket (female-female version) complete with caps	1 pc.
P2909912U	Divider for bag holder 150 L	1 pc.
P2909920U	Closing profile for central basket/bag holder complete with screws and plugs	1 pc.
P2909946A	Blue cover for bag holder 150 L with check list holder	1 pc.
P3059953E	Fixed side wall with fixing pins	3 pcs
P3059954E	Right door with fixing pins	1 pc.
P3909952E	Door with fixing pins for bag holder	1 pc.
P515010U	Supporting plastic plate with 2 wheels ø 100 mm and 2 blocking clips	1 pc.
P8169905U	150l waste bag holder for Alpha standard and 90l for AlphaSplit, male fitting, with hooks, pistons, screws and plugs	1 pc.
R1040010	Rilsan coated wringer support complete with screws	1 pc.

### ACCESSORIES TO ORDER AS SEPARATE ITEMS

0000AT0160A	Blue plastic-coated bag 57x98 cm, maximum capacity 80 L	1 pc.
0000AT0160B	Red plastified bag 57x98 cm, capacity 80 L	1 pc.
P2909915U	Pedal set for Alpha trolleys with long base or compact, closed bag holder 150 L and wheels ø 100 mm	1 pc.

### ON REQUEST, WITH SURCHARGE

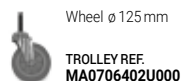

### ACCESSORIES TO ORDER AS SEPARATE ITEMS

0000AT0160A	Blue plastic-coated bag 57x98 cm, maximum capacity 80 L	1 pc.
0000AT0160B	Red plastified bag 57x98 cm, capacity 80 L	1 pc.
P2909915U	Pedal set for Alpha trolleys with long base or compact, closed bag holder 150 L and wheels ø 100 mm	1 pc.

### ON REQUEST, WITH SURCHARGE

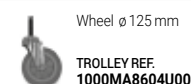

MULTIPURPOSE TROLLEYS



## ALPHA

## MORGAN

## CHROMED AND RILSAN COATED TROLLEYS

### ALPHA 0801406 - plastic trolley

**NEW**

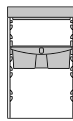

### ALPHA 0801014 - plastic trolley

**NEW**

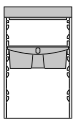

REF.	PCK	VOLUME (m³)	GROSS WEIGHT (kg)	SIZE (cm)
<b>MA0801406U000</b>	1	0,406	33,02	145x56x114

0000SE0104A	Blue plastic bucket 4 L with plastic handle	1 pc.
0000SE0104B	Red plastic bucket 4 L with plastic handle	1 pc.
0000SE0104C	Yellow plastic bucket 4 L with plastic handle	1 pc.
0000SE0104F	Green plastic bucket 4 L with plastic handle	1 pc.
0000SM00165	Set of T-shaped light grey closing plugs for vertical frames (6 pcs)	2 pc.
0020SE2742U	Kit Duo Pro - 25l mop bucket, 17l mop bucket, Duo Pro lever-operated wringer, extension for base and 2 spacers	1 pc.
3048	Set of 3 stickers for buckets	1 pc.
P066011U	Long base with wheels ø 100 mm	1 pc.
P1229906U	Grey plastic sliding drawer drawer 22 L without locking key	1 pc.
P2039903E	Vertical frame, 1 side with slides + 1 side for T-plugs, complete with screws and plugs	2 pc.
P2199906U	Central plastic basket (female-female version) complete with caps	1 pc.
P2909912U	Divider for bag holder 150 L	1 pc.
P2909920U	Closing profile for central basket/bag holder complete with screws and plugs	1 pc.
P2909946A	Blue cover for bag holder 150 L with check list holder	1 pc.
P3059953E	Fixed side wall with fixing pins	3 pcs
P3059954E	Right door with fixing pins	1 pc.
P3909952E	Door with fixing pins for bag holder	1 pc.
P515010U	Supporting plastic plate with 2 wheels ø 100 mm and 2 blocking clips	1 pc.
P8169905U	150l waste bag holder for Alpha standard and 90l for AlphaSplit, male fitting, with hooks, pistons, screws and plugs	1 pc.

#### ACCESSORIES TO ORDER AS SEPARATE ITEMS

0000AT0160A	Blue plastic-coated bag 57x98 cm, maximum capacity 80 L	1 pc.
0000AT0160B	Red plastified bag 57x98 cm, capacity 80 L	1 pc.
P2909915U	Pedal set for Alpha trolleys with long base or compact, closed bag holder 150 L and wheels ø 100 mm	1 pc.

#### ON REQUEST, WITH SURCHARGE

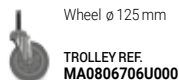

REF.	PCK	VOLUME (m³)	GROSS WEIGHT (kg)	SIZE (cm)
<b>MA0801014U000</b>	1	0,372	25,61	98x58x114

#### Complete trolley sizes with OneFred 161x65x114 cm

0000SE0104A	Blue plastic bucket 4 L with plastic handle	1 pc.
0000SE0104B	Red plastic bucket 4 L with plastic handle	1 pc.
0000SE0104C	Yellow plastic bucket 4 L with plastic handle	1 pc.
0000SE0104F	Green plastic bucket 4 L with plastic handle	1 pc.
0000SM00165	Set of T-shaped light grey closing plugs for vertical frames (6 pcs)	2 pc.
3048	Set of 3 stickers for buckets	1 pc.
P066011U	Long base with wheels ø 100 mm	1 pc.
P1229906U	Grey plastic sliding drawer drawer 22 L without locking key	1 pc.
P2039903E	Vertical frame, 1 side with slides + 1 side for T-plugs, complete with screws and plugs	2 pc.
P2199906U	Central plastic basket (female-female version) complete with caps	1 pc.
P2909912U	Divider for bag holder 150 L	1 pc.
P2909920U	Closing profile for central basket/bag holder complete with screws and plugs	1 pc.
P2909946A	Blue cover for bag holder 150 L with check list holder	1 pc.
P3059953E	Fixed side wall with fixing pins	3 pcs
P3059954E	Right door with fixing pins	1 pc.
P3909952E	Door with fixing pins for bag holder	1 pc.
P8169905U	150l waste bag holder for Alpha standard and 90l for AlphaSplit, male fitting, with hooks, pistons, screws and plugs	1 pc.

#### ACCESSORIES TO ORDER AS SEPARATE ITEMS

0000AT0160A	Blue plastic-coated bag 57x98 cm, maximum capacity 80 L	1 pc.
0000AT0160B	Red plastified bag 57x98 cm, capacity 80 L	1 pc.
0000LF0030YU	ONEFRED - 30 l plastic trolley with plastic handle	1 pc.
0000SM00298	PEG KIT - OneFred attachment kit for Alpha trolleys with broom holder	1 pc.
P2909915U	Pedal set for Alpha trolleys with long base or compact, closed bag holder 150 L and wheels ø 100 mm	1 pc.

#### ON REQUEST, WITH SURCHARGE

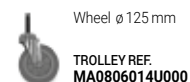

# Multipurpose trolleys



## ALPHA

## MORGAN

## CHROMED AND RILSAN COATED TROLLEYS

### ALPHA 3801400 - plastic trolley

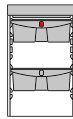



REF.	PCK	VOLUME (m³)	GROSS WEIGHT (kg)	SIZE (cm)
<b>MA3801400U002</b>	1	0,488	33,44	139x68x110
0000SE0204UA	Grey plastic bucket 4 L with blue upper plastic handle	1 pc.		
0000SE0204UB	Grey plastic bucket 4 L with red upper plastic handle	1 pc.		
0000SE0204UC	Grey plastic bucket 4 L with yellow upper plastic handle	1 pc.		
0000SE0204UF	Grey plastic bucket 4 L with green upper plastic handle	1 pc.		
0000SM00165	Set of T-shaped light grey closing plugs for vertical frames (6 pcs)	2 pc.		
3048	Set of 3 stickers for buckets	1 pc.		
7004A	REGULAR - blue plastic down-press wringer with plastic gears	1 pc.		
8108A	Blue plastic bucket 15 L with plastic handle	1 pc.		
8108B	Red plastic bucket 15 L with plastic handle	1 pc.		
P066011U	Long base with wheels ø 100 mm	1 pc.		
P1229906U	Grey plastic sliding drawer drawer 22 L without locking key	1 pc.		
P1909937U	Plastic lift for buckets, with holes for bottles, fitting drawers 22 and 40 L	1 pc.		
P2039903E	Vertical frame, 1 side with slides + 1 side for T-plugs, complete with screws and plugs	2 pc.		
P2229906U	Plastic sliding drawer 22 L with lock	1 pc.		
P2909912U	Divider for bag holder 150 L	1 pc.		
P2909920U	Closing profile for central basket/bag holder complete with screws and plugs	1 pc.		
P2909946A	Blue cover for bag holder 150 L with check list holder	1 pc.		
P3059953E	Fixed side wall with fixing pins	3 pcs		
P3059954E	Right door with fixing pins	1 pc.		
P3199903U	Central ring for 4l buckets complete with lockable grey lid and 2 pistons	1 pc.		
P3909952E	Door with fixing pins for bag holder	1 pc.		
P515010U	Supporting plastic plate with 2 wheels ø 100 mm and 2 blocking clips	1 pc.		
P8169905U	150l waste bag holder for Alpha standard and 90l for AlphaSplit, male fitting, with hooks, pistons, screws and plugs	1 pc.		
R1040010	Rilsan coated wringer support complete with screws	1 pc.		

#### ACCESSORIES TO ORDER AS SEPARATE ITEMS

0000AT0160A	Blue plastic-coated bag 57x98 cm, maximum capacity 80 L	1 pc.
0000AT0160B	Red plastified bag 57x98 cm, capacity 80 L	1 pc.
P2909915U	Pedal set for Alpha trolleys with long base or compact, closed bag holder 150 L and wheels ø 100 mm	1 pc.

#### ON REQUEST, WITH SURCHARGE

	Rubber wheels ø 125 mm TROLLEY REF. <b>MA3803400U002</b>		Wheel ø 125 mm TROLLEY REF. <b>MA3806400U002</b>		Bag holder with adjustable push-grip TROLLEY REF. <b>MA3801450U002</b>
--	---	---	---	---	---

### ALPHA 4801400 - plastic trolley

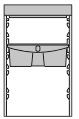

REF.	PCK	VOLUME (m³)	GROSS WEIGHT (kg)	SIZE (cm)
<b>MA4801400U002</b>	1	0,372	32,54	139x68x110
0000SE0108A	Blue plastic bucket 8 L with plastic handle	1 pc.		
0000SE0108B	Red plastic bucket 8 L with plastic handle	1 pc.		
0000SE0108C	Yellow plastic bucket 8 L with plastic handle	1 pc.		
0000SM00165	Set of T-shaped light grey closing plugs for vertical frames (6 pcs)	2 pc.		
7004A	REGULAR - blue plastic down-press wringer with plastic gears	1 pc.		
8108A	Blue plastic bucket 15 L with plastic handle	1 pc.		
8108B	Red plastic bucket 15 L with plastic handle	1 pc.		
P066011U	Long base with wheels ø 100 mm	1 pc.		
P1229906U	Grey plastic sliding drawer drawer 22 L without locking key	1 pc.		
P2039903E	Vertical frame, 1 side with slides + 1 side for T-plugs, complete with screws and plugs	2 pc.		
P2909912U	Divider for bag holder 150 L	1 pc.		
P2909920U	Closing profile for central basket/bag holder complete with screws and plugs	1 pc.		
P2909946A	Blue cover for bag holder 150 L with check list holder	1 pc.		
P3059953E	Fixed side wall with fixing pins	3 pcs		
P3059954E	Right door with fixing pins	1 pc.		
P3199905U	Central plastic frame with grey cover with locking key and 2 shock absorbing pistons for versions with 3 hanging buckets 8 L	1 pc.		
P3909952E	Door with fixing pins for bag holder	1 pc.		
P515010U	Supporting plastic plate with 2 wheels ø 100 mm and 2 blocking clips	1 pc.		
P8169905U	150l waste bag holder for Alpha standard and 90l for AlphaSplit, male fitting, with hooks, pistons, screws and plugs	1 pc.		
R1040010	Rilsan coated wringer support complete with screws	1 pc.		

#### ACCESSORIES TO ORDER AS SEPARATE ITEMS

0000AT0160A	Blue plastic-coated bag 57x98 cm, maximum capacity 80 L	1 pc.
0000AT0160B	Red plastified bag 57x98 cm, capacity 80 L	1 pc.
P2909915U	Pedal set for Alpha trolleys with long base or compact, closed bag holder 150 L and wheels ø 100 mm	1 pc.

#### ON REQUEST, WITH SURCHARGE

	Rubber wheels ø 125 mm TROLLEY REF. <b>MA4803400U002</b>		Wheel ø 125 mm TROLLEY REF. <b>MA4806400U002</b>		Bag holder with adjustable push-grip TROLLEY REF. <b>MA4801450U002</b>
---	---	---	---	---	---



ALPHA

MORGAN

CHROMED AND RILSAN COATED TROLLEYS

**ALPHA 0701450** - carrello in plastica



REF.	PCK	VOLUME (m³)	GROSS WEIGHT (kg)	SIZE (cm)
<b>MA0701450U000</b>	1	0,372	22,94	108x68x111
0000SE0104A	Blue plastic bucket 4 L with plastic handle			1 pc.
0000SE0104B	Red plastic bucket 4 L with plastic handle			1 pc.
0000SM00165	Set of T-shaped light grey closing plugs for vertical frames (6 pcs)			1 pc.
7004A	REGULAR - blue plastic down-press wringer with plastic gears			1 pc.
8108A	Blue plastic bucket 15 L with plastic handle			1 pc.
8108B	Red plastic bucket 15 L with plastic handle			1 pc.
P066011U	Long base with wheels ø 100 mm			1 pc.
P1199900U	Upper basket			1 pc.
P2039903E	Vertical frame, 1 side with slides + 1 side for T-plugs, complete with screws and plugs			1 pc.
P2909912U	Divider for bag holder 150 L			1 pc.
P2909946A	Blue cover for bag holder 150 L with check list holder			1 pc.
P3059953E	Fixed side wall with fixing pins			2 pc.
P3909952E	Door with fixing pins for bag holder			1 pc.
P8269907U	150l waste bag holder for Alpha standard and 90l for AlphaSplit, with adjustable push handle, male fitting, with hooks, pistons, screws and plugs			1 pc.
R1040010	Rilsan coated wringer support complete with screws			1 pc.

**ACCESSORIES TO ORDER AS SEPARATE ITEMS**

0000AT0160A	Blue plastic-coated bag 57x98 cm, maximum capacity 80 L	1 pc.
0000AT0160B	Red plastified bag 57x98 cm, capacity 80 L	1 pc.
P2909915U	Pedal set for Alpha trolleys with long base or compact, closed bag holder 150 L and wheels ø 100 mm	1 pc.

**ON REQUEST, WITH SURCHARGE**

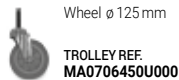



# Multipurpose trolleys



ALPHA

MORGAN

CHROMED AND RILSAN COATED TROLLEYS

## Healthcare Line

### ALPHA 1670 - plastic trolley



### ALPHA 1671 - plastic trolley



REF.	PCK	VOLUME (m³)	GROSS WEIGHT (kg)	SIZE (cm) ↓ ↓ ↓
<b>0000MA1670U00</b>	1	0,177	15,21	78x58x111
0000SE0104A	Blue plastic bucket 4 L with plastic handle			1 pc.
0000SE0104B	Red plastic bucket 4 L with plastic handle			1 pc.
0000SE1322A	TOP-DOWN® - blue plastic bucket 20 L with plastic handle and hermetic cover			1 pc.
0000SM00163	Set of T-shaped dark grey closing plugs for vertical frames (6 pcs)			1 pc.
P059061U	Short base with wheels ø 125 mm			1 pc.
P1191100U	Side plastic basket			1 pc.
P2031103U	Vertical frame with reinforcement, 1 smooth side + 1 side for T-plugs, complete with screws			1 pc.
P206030U	1x40 L + 1x80 L plastic divider for plastic bag holder 120 L			1 pc.
P8161112U	120L waste bag holder with tray, hooks, screws and plugs			1 pc.

REF.	PCK	VOLUME (m³)	GROSS WEIGHT (kg)	SIZE (cm) ↓ ↓ ↓
<b>0000MA1671U00</b>	1	0,261	16,15	78x58x111
0000SE0104A	Blue plastic bucket 4 L with plastic handle			1 pc.
0000SE0104B	Red plastic bucket 4 L with plastic handle			1 pc.
0000SE1322A	TOP-DOWN® - blue plastic bucket 20 L with plastic handle and hermetic cover			1 pc.
0000SM00163	Set of T-shaped dark grey closing plugs for vertical frames (6 pcs)			1 pc.
P059061U	Short base with wheels ø 125 mm			1 pc.
P1191100U	Side plastic basket			2 pc.
P2031103U	Vertical frame with reinforcement, 1 smooth side + 1 side for T-plugs, complete with screws			1 pc.
P206030U	1x40 L + 1x80 L plastic divider for plastic bag holder 120 L			1 pc.
P8161112U	120L waste bag holder with tray, hooks, screws and plugs			1 pc.

#### ACCESSORIES TO ORDER AS SEPARATE ITEMS

0000AT0160A	Blue plastic-coated bag 57x98 cm, maximum capacity 80 L	1 pc.
0000AT0170B	Red plastic-coated bag 48x95 cm, maximum capacity 60 L	1 pc.
P291918A	Blue cover for bag holder 120 L	1 pc.

#### ACCESSORIES TO ORDER AS SEPARATE ITEMS

0000AT0160A	Blue plastic-coated bag 57x98 cm, maximum capacity 80 L	1 pc.
0000AT0170B	Red plastic-coated bag 48x95 cm, maximum capacity 60 L	1 pc.
P291918A	Blue cover for bag holder 120 L	1 pc.

#### ON REQUEST, WITH SURCHARGE

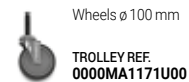
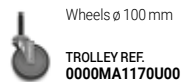



## ALPHA

## MORGAN

## CHROMED AND RILSAN COATED TROLLEYS

### ALPHA 1673 - plastic trolley



### ALPHA 0406700 - plastic trolley



REF.	PCK	VOLUME (m³)	GROSS WEIGHT (kg)	SIZE (cm) ↓ ↓ ↓
<b>0000MA1673U00</b>	1	0,261	20,05	107x58x111
0000SE0104A	Blue plastic bucket 4 L with plastic handle	1 pc.		
0000SE0104B	Red plastic bucket 4 L with plastic handle	1 pc.		
0000SE1222B	Red plastic bucket 20 L with plastic handle	1 pc.		
0000SE1322A	TOP-DOWN® - blue plastic bucket 20 L with plastic handle and hermetic cover	1 pc.		
0000SE1322B	TOP-DOWN® - red plastic bucket 20 L with plastic handle and hermetic cover	1 pc.		
0000SM00163	Set of T-shaped dark grey closing plugs for vertical frames (6 pcs)	1 pc.		
P059061U	Short base with wheels ø 125 mm	1 pc.		
P075060U	Supporting plastic plate with 1 wheel ø 125 mm	1 pc.		
P1191100U	Side plastic basket	1 pc.		
P2031103U	Vertical frame with reinforcement, 1 smooth side + 1 side for T-plugs, complete with screws	1 pc.		
P206030U	1x40 L + 1x80 L plastic divider for plastic bag holder 120 L	1 pc.		
P8161112U	120l waste bag holder with tray, hooks, screws and plugs	1 pc.		

#### ACCESSORIES TO ORDER AS SEPARATE ITEMS

0000AT0160A	Blue plastic-coated bag 57x98 cm, maximum capacity 80 L	1 pc.
0000AT0170B	Red plastic-coated bag 48x95 cm, maximum capacity 60 L	1 pc.
P291918A	Blue cover for bag holder 120 L	1 pc.

#### ON REQUEST, WITH SURCHARGE

	Rubber wheels ø 125 mm	
	Wheels ø 100 mm	
	TROLLEY REF. <b>0000MA1373U00</b>	
	TROLLEY REF. <b>0000MA1173U00</b>	

REF.	PCK	VOLUME (m³)	GROSS WEIGHT (kg)	SIZE (cm) ↓ ↓ ↓
<b>MA0406700U000</b>	1	0,291	23,26	92x58x115
0000SE1322A	TOP-DOWN® - blue plastic bucket 20 L with plastic handle and hermetic cover	2 pc.		
0000SE1322B	TOP-DOWN® - red plastic bucket 20 L with plastic handle and hermetic cover	3 pcs		
0000SM00163	Set of T-shaped dark grey closing plugs for vertical frames (6 pcs)	1 pc.		
0000SM00639	Uni-Move 2 handle holder kit	1 pc.		
P066061U	Long base with wheels ø 125 mm	1 pc.		
P1191100U	Side plastic basket	3 pcs		
P1901112U	Plastic rising support for basket art. P1191100U	4 pcs		
P2031102U	Vertical frame with reinforcement, 2 sides with T-plugs, complete with screws	1 pc.		
P2191102U	Plastic basket complete with 3 dividers fitting vertical frame Alpha trolleys	1 pc.		
P2909960U	Closing profile for vertical frame complete with screws and plugs	1 pc.		

#### ON REQUEST, WITH SURCHARGE

	Rubber wheels ø 125 mm		Wheels ø 100 mm
	TROLLEY REF. <b>MA0403700U000</b>		TROLLEY REF. <b>MA0401700U000</b>

# Multipurpose trolleys



## ALPHA

## MORGAN

## CHROMED AND RILSAN COATED TROLLEYS

### ALPHA 0406701 - plastic trolley



### ALPHA 2672 - plastic trolley



REF.	PCK	VOLUME (m³)	GROSS WEIGHT (kg)	SIZE (cm) ↓ ↓ ↓
<b>MA0406701U000</b>	1	0,36	21,9	102x58x111
0000SE1322A	TOP-DOWN® - blue plastic bucket 20 L with plastic handle and hermetic cover			1 pc.
0000SE1322B	TOP-DOWN® - red plastic bucket 20 L with plastic handle and hermetic cover			1 pc.
0000SM00163	Set of T-shaped dark grey closing plugs for vertical frames (6 pcs)			2 pc.
0000SM00610	Assembling kit to fix Handy bin to Alpha vertical frame			1 pc.
0000SM00639	Uni-Move 2 handle holder kit			1 pc.
P066061U	Long base with wheels ø 125 mm			1 pc.
P1191100U	Side plastic basket			1 pc.
P2031102U	Vertical frame with reinforcement, 2 sides with T-plugs, complete with screws			1 pc.
P2909960U	Closing profile for vertical frame complete with screws and plugs			1 pc.
P391070E	HANDY - bin 70 L with drain plug, wheels, bag stretcher and grip			1 pc.

### ON REQUEST, WITH SURCHARGE

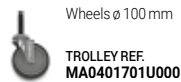

REF.	PCK	VOLUME (m³)	GROSS WEIGHT (kg)	SIZE (cm) ↓ ↓ ↓
<b>0000MA2672U00</b>	1	0,372	25,57	118x58x114
0000SE0104A	Blue plastic bucket 4 L with plastic handle			1 pc.
0000SE0104B	Red plastic bucket 4 L with plastic handle			1 pc.
0000SE0104C	Yellow plastic bucket 4 L with plastic handle			1 pc.
0000SE0104F	Green plastic bucket 4 L with plastic handle			1 pc.
0000SE1222B	Red plastic bucket 20 L with plastic handle			1 pc.
0000SE1322A	TOP-DOWN® - blue plastic bucket 20 L with plastic handle and hermetic cover			1 pc.
0000SE1322B	TOP-DOWN® - red plastic bucket 20 L with plastic handle and hermetic cover			1 pc.
0000SM00165	Set of T-shaped light grey closing plugs for vertical frames (6 pcs)			2 pc.
3048	Set of 3 stickers for buckets			1 pc.
P059061U	Short base with wheels ø 125 mm			1 pc.
P1191100U	Side plastic basket			2 pc.
P1229906U	Grey plastic sliding drawer 22 L without locking key			1 pc.
P165000U	Base extension for Alpha trolleys and for the bag supporting plastic plate of the Morgan Hotel Elegance trolleys			1 pc.
P2039903E	Vertical frame, 1 side with slides + 1 side for T-plugs, complete with screws and plugs			2 pc.
P206030U	1x40 L + 1x80 L plastic divider for plastic bag holder 120 L			1 pc.
P2199906U	Central plastic basket (female-female version) complete with caps			1 pc.
P2909920U	Closing profile for central basket/bag holder complete with screws and plugs			1 pc.
P8161111U	120l waste bag holder, male fitting, with dustpan hook and handle clip			1 pc.

### ACCESSORIES TO ORDER AS SEPARATE ITEMS

0000AT0160A	Blue plastic-coated bag 57x98 cm, maximum capacity 80 L	1 pc.
0000AT0170B	Red plastic-coated bag 48x95 cm, maximum capacity 60 L	1 pc.
P291918A	Blue cover for bag holder 120 L	1 pc.

### ON REQUEST, WITH SURCHARGE

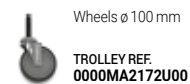



## ALPHA

## MORGAN

## CHROMED AND RILSAN COATED TROLLEYS

### ALPHA 3306700 - plastic trolley



### ALPHA 5671 - plastic trolley

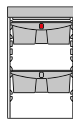

REF.	PCK	VOLUME (m³)	GROSS WEIGHT (kg)	SIZE (cm)
<b>MA3306700U000</b>	1	0,372	29,47	118x58x110
0000SE0204UA	Grey plastic bucket 4 L with blue upper plastic handle	1 pc.		
0000SE0204UB	Grey plastic bucket 4 L with red upper plastic handle	1 pc.		
0000SE0204UC	Grey plastic bucket 4 L with yellow upper plastic handle	1 pc.		
0000SE0204UF	Grey plastic bucket 4 L with green upper plastic handle	1 pc.		
0000SE1322A	TOP-DOWN® - blue plastic bucket 20 L with plastic handle and hermetic cover	1 pc.		
0000SE1322B	TOP-DOWN® - red plastic bucket 20 L with plastic handle and hermetic cover	1 pc.		
0000SM00165	Set of T-shaped light grey closing plugs for vertical frames (6 pcs)	2 pc.		
3048	Set of 3 stickers for buckets	1 pc.		
P059061U	Short base with wheels ø 125 mm	1 pc.		
P1191100U	Side plastic basket	2 pc.		
P1229906U	Grey plastic sliding drawer drawer 22 L without locking key	1 pc.		
P175000U	Supporting plastic plate for Alpha trolleys	1 pc.		
P1909937U	Plastic lift for buckets, with holes for bottles, fitting drawers 22 and 40 L	1 pc.		
P2039903E	Vertical frame, 1 side with slides + 1 side for T-plugs, complete with screws and plugs	2 pc.		
P206030U	1x40 L + 1x80 L plastic divider for plastic bag holder 120 L	1 pc.		
P2229906U	Plastic sliding drawer 22 L with lock	1 pc.		
P2909920U	Closing profile for central basket/bag holder complete with screws and plugs	1 pc.		
P3059953E	Fixed side wall with fixing pins	1 pc.		
P3059954E	Right door with fixing pins	1 pc.		
P3199903U	Central ring for 4l buckets complete with lockable grey lid and 2 pistons	1 pc.		
P8161115U	Folding 120l waste bag holder with deep fitting, with bag retaining hooks, dustpan hook, handle clip, screws and plugs	1 pc.		

REF.	PCK	VOLUME (m³)	GROSS WEIGHT (kg)	SIZE (cm)
<b>0000MA5671U00</b>	1	0,372	26,37	118x58x114
0000SE0104A	Blue plastic bucket 4 L with plastic handle	1 pc.		
0000SE0104B	Red plastic bucket 4 L with plastic handle	1 pc.		
0000SE0104C	Yellow plastic bucket 4 L with plastic handle	1 pc.		
0000SE0104F	Green plastic bucket 4 L with plastic handle	1 pc.		
0000SE1222B	Red plastic bucket 20 L with plastic handle	1 pc.		
0000SE1322A	TOP-DOWN® - blue plastic bucket 20 L with plastic handle and hermetic cover	1 pc.		
0000SE1322B	TOP-DOWN® - red plastic bucket 20 L with plastic handle and hermetic cover	1 pc.		
0000SM00165	Set of T-shaped light grey closing plugs for vertical frames (6 pcs)	2 pc.		
3048	Set of 3 stickers for buckets	1 pc.		
P066061U	Long base with wheels ø 125 mm	1 pc.		
P1191100U	Side plastic basket	1 pc.		
P1229906U	Grey plastic sliding drawer drawer 22 L without locking key	1 pc.		
P165000U	Base extension for Alpha trolleys and for the bag supporting plastic plate of the Morgan Hotel Elegance trolleys	1 pc.		
P2039903E	Vertical frame, 1 side with slides + 1 side for T-plugs, complete with screws and plugs	2 pc.		
P206030U	1x40 L + 1x80 L plastic divider for plastic bag holder 120 L	1 pc.		
P2199906U	Central plastic basket (female-female version) complete with caps	1 pc.		
P2909920U	Closing profile for central basket/bag holder complete with screws and plugs	1 pc.		
P8161111U	120l waste bag holder, male fitting, with dustpan hook and handle clip	1 pc.		

#### ACCESSORIES TO ORDER AS SEPARATE ITEMS

0000AT0160A	Blue plastic-coated bag 57x98 cm, maximum capacity 80 L	1 pc.
0000AT0170B	Red plastic-coated bag 48x95 cm, maximum capacity 60 L	1 pc.
P291918A	Blue cover for bag holder 120 L	1 pc.

#### ON REQUEST, WITH SURCHARGE

	Rubber wheels ø 125 mm		Wheels ø 100 mm
	TROLLEY REF. 0000MA5371U00		TROLLEY REF. 0000MA5171U00

#### ACCESSORIES TO ORDER AS SEPARATE ITEMS

0000AT0160A	Blue plastic-coated bag 57x98 cm, maximum capacity 80 L	1 pc.
0000AT0170B	Red plastic-coated bag 48x95 cm, maximum capacity 60 L	1 pc.
P291918A	Blue cover for bag holder 120 L	1 pc.

#### ON REQUEST, WITH SURCHARGE

	Rubber wheels ø 125 mm		Wheels ø 100 mm
	TROLLEY REF. MA3303700U000		TROLLEY REF. MA3301700U000

# Multipurpose trolleys



## ALPHA

## MORGAN

## CHROMED AND RILSAN COATED TROLLEYS

### ALPHA 0506700 - plastic trolley



### ALPHA 6670 - plastic trolley



REF.	PCK	VOLUME (m <sup>3</sup> )	GROSS WEIGHT (kg)	SIZE (cm) ↓ ↓ ↓
<b>MA0506700U003</b>	1	0,47	30,58	123x65x118

0000SE0104A	Blue plastic bucket 4 L with plastic handle	1 pc.
0000SE0104B	Red plastic bucket 4 L with plastic handle	1 pc.
0000SE0104C	Yellow plastic bucket 4 L with plastic handle	1 pc.
0000SE0104F	Green plastic bucket 4 L with plastic handle	1 pc.
0000SE1222B	Red plastic bucket 20 L with plastic handle	1 pc.
0000SE1322A	TOP-DOWN® - blue plastic bucket 20 L with plastic handle and hermetic cover	1 pc.
0000SE1322B	TOP-DOWN® - red plastic bucket 20 L with plastic handle and hermetic cover	1 pc.
0000SM00165	Set of T-shaped light grey closing plugs for vertical frames (6 pcs)	2 pc.
3048	Set of 3 stickers for buckets	1 pc.
P066061U	Long base with wheels ø 125 mm	1 pc.
P1229906U	Grey plastic sliding drawer drawer 22 L without locking key	1 pc.
P2039903E	Vertical frame, 1 side with slides + 1 side for T-plugs, complete with screws and plugs	2 pc.
P206030U	1x40 L + 1x80 L plastic divider for plastic bag holder 120 L	1 pc.
P2199906U	Central plastic basket (female-female version) complete with caps	1 pc.
P2909920U	Closing profile for central basket/bag holder complete with screws and plugs	1 pc.
P8161111U	120l waste bag holder, male fitting, with dustpan hook and handle clip	1 pc.
R2200040	Rilsan coated bucket holder for buckets 10 and 20 L fitting Morgan vertical frame and Alpha trolley	1 pc.
R3030133	Square Rilsan trolley with 200mm ø wheels, plastic support, trolley retaining set and Bis hook, for 10- and 20-litre Top-Down buckets	1 pc.

#### ACCESSORIES TO ORDER AS SEPARATE ITEMS

0000AT0160A	Blue plastic-coated bag 57x98 cm, maximum capacity 80 L	1 pc.
0000AT0170B	Red plastic-coated bag 48x95 cm, maximum capacity 60 L	1 pc.
P291918A	Blue cover for bag holder 120 L	1 pc.

#### ON REQUEST, WITH SURCHARGE



REF.	PCK	VOLUME (m <sup>3</sup> )	GROSS WEIGHT (kg)	SIZE (cm) ↓ ↓ ↓
<b>0000MA6670U00</b>	1	0,372	26,37	118x58x114

0000SE0104A	Blue plastic bucket 4 L with plastic handle	1 pc.
0000SE0104B	Red plastic bucket 4 L with plastic handle	1 pc.
0000SE0104C	Yellow plastic bucket 4 L with plastic handle	1 pc.
0000SE0104F	Green plastic bucket 4 L with plastic handle	1 pc.
0000SE1322A	TOP-DOWN® - blue plastic bucket 20 L with plastic handle and hermetic cover	1 pc.
0000SE1322B	TOP-DOWN® - red plastic bucket 20 L with plastic handle and hermetic cover	1 pc.
0000SM00165	Set of T-shaped light grey closing plugs for vertical frames (6 pcs)	2 pc.
3048	Set of 3 stickers for buckets	1 pc.
P066061U	Long base with wheels ø 125 mm	1 pc.
P1191100U	Side plastic basket	2 pc.
P1229906U	Grey plastic sliding drawer drawer 22 L without locking key	1 pc.
P2039903E	Vertical frame, 1 side with slides + 1 side for T-plugs, complete with screws and plugs	2 pc.
P206030U	1x40 L + 1x80 L plastic divider for plastic bag holder 120 L	1 pc.
P2199906U	Central plastic basket (female-female version) complete with caps	1 pc.
P2909920U	Closing profile for central basket/bag holder complete with screws and plugs	1 pc.
P3059953E	Fixed side wall with fixing pins	1 pc.
P3059954E	Right door with fixing pins	1 pc.
P8161111U	120l waste bag holder, male fitting, with dustpan hook and handle clip	1 pc.

#### ACCESSORIES TO ORDER AS SEPARATE ITEMS

0000AT0160A	Blue plastic-coated bag 57x98 cm, maximum capacity 80 L	1 pc.
0000AT0170B	Red plastic-coated bag 48x95 cm, maximum capacity 60 L	1 pc.
P291918A	Blue cover for bag holder 120 L	1 pc.

#### ON REQUEST, WITH SURCHARGE

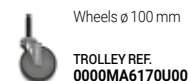



## ALPHA

## MORGAN

## CHROMED AND RILSAN COATED TROLLEYS

### ALPHA 3606700 - plastic trolley



### ALPHA 3806701 - plastic trolley

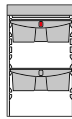
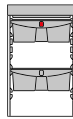

REF.	PCK	VOLUME (m³)	GROSS WEIGHT (kg)	SIZE (cm)
<b>MA3606700U000</b>	1	0,471	33,91	123x65x118
0000SE0204UA	Grey plastic bucket 4 L with blue upper plastic handle	1 pc.		
0000SE0204UB	Grey plastic bucket 4 L with red upper plastic handle	1 pc.		
0000SE0204UC	Grey plastic bucket 4 L with yellow upper plastic handle	1 pc.		
0000SE0204UF	Grey plastic bucket 4 L with green upper plastic handle	1 pc.		
0000SE1322A	TOP-DOWN® - blue plastic bucket 20 L with plastic handle and hermetic cover	1 pc.		
0000SE1322B	TOP-DOWN® - red plastic bucket 20 L with plastic handle and hermetic cover	1 pc.		
0000SM00165	Set of T-shaped light grey closing plugs for vertical frames (6 pcs)	2 pc.		
3048	Set of 3 stickers for buckets	1 pc.		
P066061U	Long base with wheels ø 125 mm	1 pc.		
P1229906U	Grey plastic sliding drawer drawer 22 L without locking key	1 pc.		
P1909937U	Plastic lift for buckets, with holes for bottles, fitting drawers 22 and 40 L	1 pc.		
P2039903E	Vertical frame, 1 side with slides + 1 side for T-plugs, complete with screws and plugs	2 pc.		
P206030U	1x40 L + 1x80 L plastic divider for plastic bag holder 120 L	1 pc.		
P2229906U	Plastic sliding drawer 22 L with lock	1 pc.		
P2909920U	Closing profile for central basket/bag holder complete with screws and plugs	1 pc.		
P3059953E	Fixed side wall with fixing pins	1 pc.		
P3059954E	Right door with fixing pins	1 pc.		
P3199903U	Central ring for 4l buckets complete with lockable grey lid and 2 pistons	1 pc.		
P8161111U	120l waste bag holder, male fitting, with dustpan hook and handle clip	1 pc.		
R2200040	Rilsan coated bucket holder for buckets 10 and 20 L fitting Morgan vertical frame and Alpha trolley	1 pc.		
R3030133	Square Rilsan trolley with 200mm ø wheels, plastic support, trolley retaining set and Bis hook, for 10- and 20-litre Top-Down buckets	1 pc.		

REF.	PCK	VOLUME (m³)	GROSS WEIGHT (kg)	SIZE (cm)
<b>MA3806701U002</b>	1	0,488	30,74	120x58x110
0000SE0204UA	Grey plastic bucket 4 L with blue upper plastic handle	1 pc.		
0000SE0204UB	Grey plastic bucket 4 L with red upper plastic handle	1 pc.		
0000SE0204UC	Grey plastic bucket 4 L with yellow upper plastic handle	1 pc.		
0000SE0204UF	Grey plastic bucket 4 L with green upper plastic handle	1 pc.		
0000SE1322A	TOP-DOWN® - blue plastic bucket 20 L with plastic handle and hermetic cover	1 pc.		
0000SM00165	Set of T-shaped light grey closing plugs for vertical frames (6 pcs)	2 pc.		
3048	Set of 3 stickers for buckets	1 pc.		
P066061U	Long base with wheels ø 125 mm	1 pc.		
P1229906U	Grey plastic sliding drawer drawer 22 L without locking key	1 pc.		
P165000U	Base extension for Alpha trolleys and for the bag supporting plastic plate of the Morgan Hotel Elegance trolleys	1 pc.		
P1909937U	Plastic lift for buckets, with holes for bottles, fitting drawers 22 and 40 L	1 pc.		
P2039903E	Vertical frame, 1 side with slides + 1 side for T-plugs, complete with screws and plugs	2 pc.		
P2229906U	Plastic sliding drawer 22 L with lock	1 pc.		
P2909912U	Divider for bag holder 150 L	1 pc.		
P2909920U	Closing profile for central basket/bag holder complete with screws and plugs	1 pc.		
P2909946A	Blue cover for bag holder 150 L with check list holder	1 pc.		
P3059953E	Fixed side wall with fixing pins	3 pcs		
P3059954E	Right door with fixing pins	1 pc.		
P3199903U	Central ring for 4l buckets complete with lockable grey lid and 2 pistons	1 pc.		
P3909952E	Door with fixing pins for bag holder	1 pc.		
P8169905U	150l waste bag holder for Alpha standard and 90l for AlphaSplit, male fitting, with hooks, pistons, screws and plugs	1 pc.		

#### ACCESSORIES TO ORDER AS SEPARATE ITEMS

0000AT0160A	Blue plastic-coated bag 57x98 cm, maximum capacity 80 L	1 pc.
0000AT0170B	Red plastic-coated bag 48x95 cm, maximum capacity 60 L	1 pc.
P291918A	Blue cover for bag holder 120 L	1 pc.

#### ACCESSORIES TO ORDER AS SEPARATE ITEMS

0000AT0160A	Blue plastic-coated bag 57x98 cm, maximum capacity 80 L	1 pc.
0000AT0160B	Red plastified bag 57x98 cm, capacity 80 L	1 pc.
P2909962U	Pedal set for Alpha trolleys with long base or compact, closed bag holder 150 L and wheels ø 125 mm	1 pc.

#### ON REQUEST, WITH SURCHARGE

	Rubber wheels ø 125 mm	TROLLEY REF. MA3603700U000
	Wheels ø 100 mm	TROLLEY REF. MA3601700U000

	Rubber wheels ø 125 mm	TROLLEY REF. MA3803701U002
	Wheels ø 100 mm	TROLLEY REF. MA3801701U002
	Bag holder with adjustable push-grip	TROLLEY REF. MA3806751U002

# Multipurpose trolleys



## ALPHA

## MORGAN

## CHROMED AND RILSAN COATED TROLLEYS

### ALPHA 8670 - plastic trolley

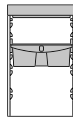

### ALPHA 0806708 - plastic trolley

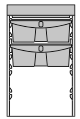
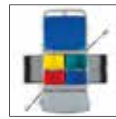

REF.	PCK	VOLUME (m <sup>3</sup> )	GROSS WEIGHT (kg)	SIZE (cm)
<b>3000MA8670U00</b>	1	0,372	30,87	120x58x114
0000SE0104A	Blue plastic bucket 4 L with plastic handle	1 pc.		
0000SE0104B	Red plastic bucket 4 L with plastic handle	1 pc.		
0000SE0104C	Yellow plastic bucket 4 L with plastic handle	1 pc.		
0000SE0104F	Green plastic bucket 4 L with plastic handle	1 pc.		
0000SE1322A	TOP-DOWN® - blue plastic bucket 20 L with plastic handle and hermetic cover	1 pc.		
0000SE1322B	TOP-DOWN® - red plastic bucket 20 L with plastic handle and hermetic cover	1 pc.		
0000SM00165	Set of T-shaped light grey closing plugs for vertical frames (6 pcs)	2 pc.		
3048	Set of 3 stickers for buckets	1 pc.		
P066061U	Long base with wheels ø 125 mm	1 pc.		
P1191100U	Side plastic basket	2 pc.		
P1229906U	Grey plastic sliding drawer drawer 22 L without locking key	1 pc.		
P2039903E	Vertical frame, 1 side with slides + 1 side for T-plugs, complete with screws and plugs	2 pc.		
P2199906U	Central plastic basket (female-female version) complete with caps	1 pc.		
P2909912U	Divider for bag holder 150 L	1 pc.		
P2909920U	Closing profile for central basket/bag holder complete with screws and plugs	1 pc.		
P2909946A	Blue cover for bag holder 150 L with check list holder	1 pc.		
P3059953E	Fixed side wall with fixing pins	3 pcs		
P3059954E	Right door with fixing pins	1 pc.		
P3909952E	Door with fixing pins for bag holder	1 pc.		
P8169905U	150L waste bag holder for Alpha standard and 90l for AlphaSplit, male fitting, with hooks, pistons, screws and plugs	1 pc.		

REF.	PCK	VOLUME (m <sup>3</sup> )	GROSS WEIGHT (kg)	SIZE (cm)
<b>MA0806708U000</b>	1	0,488	31,08	120x58x114
0000SE0104A	Blue plastic bucket 4 L with plastic handle	1 pc.		
0000SE0104B	Red plastic bucket 4 L with plastic handle	1 pc.		
0000SE0104C	Yellow plastic bucket 4 L with plastic handle	1 pc.		
0000SE0104F	Green plastic bucket 4 L with plastic handle	1 pc.		
0000SE1322A	TOP-DOWN® - blue plastic bucket 20 L with plastic handle and hermetic cover	1 pc.		
0000SE1322B	TOP-DOWN® - red plastic bucket 20 L with plastic handle and hermetic cover	1 pc.		
0000SM00165	Set of T-shaped light grey closing plugs for vertical frames (6 pcs)	2 pc.		
3048	Set of 3 stickers for buckets	1 pc.		
P066061U	Long base with wheels ø 125 mm	1 pc.		
P1191100U	Side plastic basket	2 pc.		
P1229906U	Grey plastic sliding drawer drawer 22 L without locking key	2 pc.		
P2039903E	Vertical frame, 1 side with slides + 1 side for T-plugs, complete with screws and plugs	2 pc.		
P2199906U	Central plastic basket (female-female version) complete with caps	1 pc.		
P2909912U	Divider for bag holder 150 L	1 pc.		
P2909920U	Closing profile for central basket/bag holder complete with screws and plugs	1 pc.		
P2909946A	Blue cover for bag holder 150 L with check list holder	1 pc.		
P3059953E	Fixed side wall with fixing pins	2 pc.		
P3059954E	Right door with fixing pins	2 pc.		
P3909952E	Door with fixing pins for bag holder	1 pc.		
P8169905U	150L waste bag holder for Alpha standard and 90l for AlphaSplit, male fitting, with hooks, pistons, screws and plugs	1 pc.		

#### ACCESSORIES TO ORDER AS SEPARATE ITEMS

0000AT0160A	Blue plastic-coated bag 57x98 cm, maximum capacity 80 L	1 pc.
0000AT0160B	Red plastified bag 57x98 cm, capacity 80 L	1 pc.
P2909962U	Pedal set for Alpha trolleys with long base or compact, closed bag holder 150 L and wheels ø 125 mm	1 pc.

#### ACCESSORIES TO ORDER AS SEPARATE ITEMS

0000AT0160A	Blue plastic-coated bag 57x98 cm, maximum capacity 80 L	1 pc.
0000AT0160B	Red plastified bag 57x98 cm, capacity 80 L	1 pc.
P2909962U	Pedal set for Alpha trolleys with long base or compact, closed bag holder 150 L and wheels ø 125 mm	1 pc.

#### ON REQUEST, WITH SURCHARGE

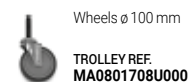
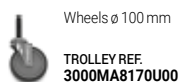



## ALPHA

## MORGAN

## CHROMED AND RILSAN COATED TROLLEYS

### ALPHA 0806700 - plastic trolley

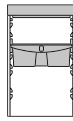

### ALPHA 3806700 - plastic trolley

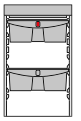
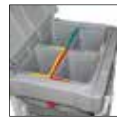

REF.	PCK	VOLUME (m <sup>3</sup> )	GROSS WEIGHT (kg)	SIZE (cm)
<b>MA0806700U001</b>	1	1,847	32	125x65x118
0000SE0104A	Blue plastic bucket 4 L with plastic handle	1 pc.		
0000SE0104B	Red plastic bucket 4 L with plastic handle	1 pc.		
0000SE0104C	Yellow plastic bucket 4 L with plastic handle	1 pc.		
0000SE0104F	Green plastic bucket 4 L with plastic handle	1 pc.		
0000SE1322A	TOP-DOWN® - blue plastic bucket 20 L with plastic handle and hermetic cover	1 pc.		
0000SE1322B	TOP-DOWN® - red plastic bucket 20 L with plastic handle and hermetic cover	1 pc.		
0000SM00165	Set of T-shaped light grey closing plugs for vertical frames (6 pcs)	2 pc.		
3048	Set of 3 stickers for buckets	1 pc.		
P066061U	Long base with wheels ø 125 mm	1 pc.		
P1229906U	Grey plastic sliding drawer drawer 22 L without locking key	1 pc.		
P2039903E	Vertical frame, 1 side with slides + 1 side for T-plugs, complete with screws and plugs	2 pc.		
P2199906U	Central plastic basket (female-female version) complete with caps	1 pc.		
P2909912U	Divider for bag holder 150 L	1 pc.		
P2909920U	Closing profile for central basket/bag holder complete with screws and plugs	1 pc.		
P2909946A	Blue cover for bag holder 150 L with check list holder	1 pc.		
P3059953E	Fixed side wall with fixing pins	3 pcs		
P3059954E	Right door with fixing pins	1 pc.		
P3909952E	Door with fixing pins for bag holder	1 pc.		
P8169905U	150l waste bag holder for Alpha standard and 90l for AlphaSplit, male fitting, with hooks, pistons, screws and plugs	1 pc.		
R2200040	Rilsan coated bucket holder for buckets 10 and 20 L fitting Morgan vertical frame and Alpha trolley	1 pc.		
R3030133	Square Rilsan trolley with 200mm ø wheels, plastic support, trolley retaining set and Bis hook, for 10- and 20-litre Top-Down buckets	1 pc.		

#### ACCESSORIES TO ORDER AS SEPARATE ITEMS

0000AT0160A	Blue plastic-coated bag 57x98 cm, maximum capacity 80 L	1 pc.
0000AT0160B	Red plastified bag 57x98 cm, capacity 80 L	1 pc.
P2909962U	Pedal set for Alpha trolleys with long base or compact, closed bag holder 150 L and wheels ø 125 mm	1 pc.

#### ON REQUEST, WITH SURCHARGE

	Rubber wheels ø 125 mm	TROLLEY REF. MA0803700U001
	Wheels ø 100 mm	TROLLEY REF. MA0801700U001
	Bag holder with adjustable push-grip	TROLLEY REF. MA0806750U001

REF.	PCK	VOLUME (m <sup>3</sup> )	GROSS WEIGHT (kg)	SIZE (cm)
<b>MA3806700U001</b>	1	0,582	42	125x65x118
0000SE0204UA	Grey plastic bucket 4 L with blue upper plastic handle	1 pc.		
0000SE0204UB	Grey plastic bucket 4 L with red upper plastic handle	1 pc.		
0000SE0204UC	Grey plastic bucket 4 L with yellow upper plastic handle	1 pc.		
0000SE0204UF	Grey plastic bucket 4 L with green upper plastic handle	1 pc.		
0000SE1322A	TOP-DOWN® - blue plastic bucket 20 L with plastic handle and hermetic cover	1 pc.		
0000SE1322B	TOP-DOWN® - red plastic bucket 20 L with plastic handle and hermetic cover	1 pc.		
0000SM00165	Set of T-shaped light grey closing plugs for vertical frames (6 pcs)	2 pc.		
3048	Set of 3 stickers for buckets	1 pc.		
P066061U	Long base with wheels ø 125 mm	1 pc.		
P1229906U	Grey plastic sliding drawer drawer 22 L without locking key	1 pc.		
P1909937U	Plastic lift for buckets, with holes for bottles, fitting drawers 22 and 40 L	1 pc.		
P2039903E	Vertical frame, 1 side with slides + 1 side for T-plugs, complete with screws and plugs	2 pc.		
P2229906U	Plastic sliding drawer 22 L with lock	1 pc.		
P2909912U	Divider for bag holder 150 L	1 pc.		
P2909920U	Closing profile for central basket/bag holder complete with screws and plugs	1 pc.		
P2909946A	Blue cover for bag holder 150 L with check list holder	1 pc.		
P3059953E	Fixed side wall with fixing pins	3 pcs		
P3059954E	Right door with fixing pins	1 pc.		
P3199903U	Central ring for 4l buckets complete with lockable grey lid and 2 pistons	1 pc.		
P3909952E	Door with fixing pins for bag holder	1 pc.		
P8169905U	150l waste bag holder for Alpha standard and 90l for AlphaSplit, male fitting, with hooks, pistons, screws and plugs	1 pc.		
R2200040	Rilsan coated bucket holder for buckets 10 and 20 L fitting Morgan vertical frame and Alpha trolley	1 pc.		
R3030133	Square Rilsan trolley with 200mm ø wheels, plastic support, trolley retaining set and Bis hook, for 10- and 20-litre Top-Down buckets	1 pc.		

#### ACCESSORIES TO ORDER AS SEPARATE ITEMS

0000AT0160A	Blue plastic-coated bag 57x98 cm, maximum capacity 80 L	1 pc.
0000AT0160B	Red plastified bag 57x98 cm, capacity 80 L	1 pc.
P2909962U	Pedal set for Alpha trolleys with long base or compact, closed bag holder 150 L and wheels ø 125 mm	1 pc.

#### ON REQUEST, WITH SURCHARGE

	Rubber wheels ø 125 mm	TROLLEY REF. MA3803700U001
	Wheels ø 100 mm	TROLLEY REF. MA3801700U001
	Bag holder with adjustable push-grip	TROLLEY REF. MA3806750U001



# Multipurpose trolleys



## ALPHA

## MORGAN

## CHROMED AND RILSAN COATED TROLLEYS

### ALPHA 0206703 - plastic trolley



### ALPHA 0306702 - plastic trolley



REF.	PCK	VOLUME (m <sup>3</sup> )	GROSS WEIGHT (kg)	SIZE (cm) ↓ ↓ ↓
<b>MA0206703U000</b>	1	0,27	21,01	121x58x114

0000SE0104A	Blue plastic bucket 4 L with plastic handle	1 pc.
0000SE0104B	Red plastic bucket 4 L with plastic handle	1 pc.
0000SE0104C	Yellow plastic bucket 4 L with plastic handle	1 pc.
0000SE0104F	Green plastic bucket 4 L with plastic handle	1 pc.
0000SE1322A	TOP-DOWN® - blue plastic bucket 20 L with plastic handle and hermetic cover	1 pc.
0000SM00165	Set of T-shaped light grey closing plugs for vertical frames (6 pcs)	2 pc.
3048	Set of 3 stickers for buckets	1 pc.
P059061U	Short base with wheels ø 125 mm	1 pc.
P1229906U	Grey plastic sliding drawer drawer 22 L without locking key	1 pc.
P165001U	Plastic extension for Alpha base	1 pc.
P175000U	Supporting plastic plate for Alpha trolleys	1 pc.
P2039903E	Vertical frame, 1 side with slides + 1 side for T-plugs, complete with screws and plugs	2 pc.
P206030U	1x40 L + 1x80 L plastic divider for plastic bag holder 120 L	1 pc.
P2199906U	Central plastic basket (female-female version) complete with caps	1 pc.
P2909920U	Closing profile for central basket/bag holder complete with screws and plugs	1 pc.
P8161113U	Folding 120L waste bag holder, with bag retaining hooks, dustpan hook, handle clip, screws and plugs	1 pc.

#### ACCESSORIES TO ORDER AS SEPARATE ITEMS

0000AT0160A	Blue plastic-coated bag 57x98 cm, maximum capacity 80 L	1 pc.
0000AT0170B	Red plastic-coated bag 48x95 cm, maximum capacity 60 L	1 pc.
P291918A	Blue cover for bag holder 120 L	1 pc.
P320100UA	EQUODOSE - dosing device with one tank 6 L for mop soaking on demand	1 pc.

#### ON REQUEST, WITH SURCHARGE

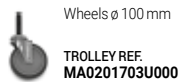

REF.	PCK	VOLUME (m <sup>3</sup> )	GROSS WEIGHT (kg)	SIZE (cm) ↓ ↓ ↓
<b>MA0306702U000</b>	1	0,372	23,87	121x58x114

0000SE0104A	Blue plastic bucket 4 L with plastic handle	1 pc.
0000SE0104B	Red plastic bucket 4 L with plastic handle	1 pc.
0000SE0104C	Yellow plastic bucket 4 L with plastic handle	1 pc.
0000SE0104F	Green plastic bucket 4 L with plastic handle	1 pc.
0000SE1322A	TOP-DOWN® - blue plastic bucket 20 L with plastic handle and hermetic cover	1 pc.
0000SM00165	Set of T-shaped light grey closing plugs for vertical frames (6 pcs)	2 pc.
3048	Set of 3 stickers for buckets	1 pc.
P059061U	Short base with wheels ø 125 mm	1 pc.
P1229906U	Grey plastic sliding drawer drawer 22 L without locking key	1 pc.
P165001U	Plastic extension for Alpha base	1 pc.
P175000U	Supporting plastic plate for Alpha trolleys	1 pc.
P2039903E	Vertical frame, 1 side with slides + 1 side for T-plugs, complete with screws and plugs	2 pc.
P206030U	1x40 L + 1x80 L plastic divider for plastic bag holder 120 L	1 pc.
P2199906U	Central plastic basket (female-female version) complete with caps	1 pc.
P2909920U	Closing profile for central basket/bag holder complete with screws and plugs	1 pc.
P3059953E	Fixed side wall with fixing pins	1 pc.
P3059954E	Right door with fixing pins	1 pc.
P8161113U	Folding 120L waste bag holder, with bag retaining hooks, dustpan hook, handle clip, screws and plugs	1 pc.

#### ACCESSORIES TO ORDER AS SEPARATE ITEMS

0000AT0160A	Blue plastic-coated bag 57x98 cm, maximum capacity 80 L	1 pc.
0000AT0170B	Red plastic-coated bag 48x95 cm, maximum capacity 60 L	1 pc.
P291918A	Blue cover for bag holder 120 L	1 pc.
P320100UA	EQUODOSE - dosing device with one tank 6 L for mop soaking on demand	1 pc.

#### ON REQUEST, WITH SURCHARGE





## ALPHA

## MORGAN

## CHROMED AND RILSAN COATED TROLLEYS

### ALPHA 3606705 - plastic trolley

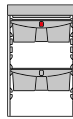

REF.	PCK	VOLUME (m <sup>3</sup> )	GROSS WEIGHT (kg)	SIZE (cm)
<b>MA3606705U000</b>	1	0,372	28,07	140x58x110
0000SE0204UA	Grey plastic bucket 4 L with blue upper plastic handle	1 pc.		
0000SE0204UB	Grey plastic bucket 4 L with red upper plastic handle	1 pc.		
0000SE0204UC	Grey plastic bucket 4 L with yellow upper plastic handle	1 pc.		
0000SE0204UF	Grey plastic bucket 4 L with green upper plastic handle	1 pc.		
0000SE1322A	TOP-DOWN® - blue plastic bucket 20 L with plastic handle and hermetic cover	1 pc.		
0000SM00165	Set of T-shaped light grey closing plugs for vertical frames (6 pcs)	2 pc.		
3048	Set of 3 stickers for buckets	1 pc.		
P066061U	Long base with wheels ø 125 mm	1 pc.		
P1229906U	Grey plastic sliding drawer drawer 22 L without locking key	1 pc.		
P175000U	Supporting plastic plate for Alpha trolleys	1 pc.		
P1909937U	Plastic lift for buckets, with holes for bottles, fitting drawers 22 and 40 L	1 pc.		
P2039903E	Vertical frame, 1 side with slides + 1 side for T-plugs, complete with screws and plugs	2 pc.		
P206030U	1x40 L + 1x80 L plastic divider for plastic bag holder 120 L	1 pc.		
P2229906U	Plastic sliding drawer 22 L with lock	1 pc.		
P2909920U	Closing profile for central basket/bag holder complete with screws and plugs	1 pc.		
P3059953E	Fixed side wall with fixing pins	1 pc.		
P3059954E	Right door with fixing pins	1 pc.		
P3199903U	Central ring for 4l buckets complete with lockable grey lid and 2 pistons	1 pc.		
P8161115U	Folding 120l waste bag holder with deep fitting, with bag retaining hooks, dustpan hook, handle clip, screws and plugs	1 pc.		

### ACCESSORIES TO ORDER AS SEPARATE ITEMS

0000AT0160A	Blue plastic-coated bag 57x98 cm, maximum capacity 80 L	1 pc.
0000AT0170B	Red plastic-coated bag 48x95 cm, maximum capacity 60 L	1 pc.
P291918A	Blue cover for bag holder 120 L	1 pc.
P320200UA	EQUODOSE - dosing device with two tanks 6 L for mop soaking on demand	1 pc.

### ON REQUEST, WITH SURCHARGE

	Rubber wheels ø 125 mm	TROLLEY REF. <b>MA3603705U000</b>
	Wheels ø 100 mm	TROLLEY REF. <b>MA3601705U000</b>

### ALPHA 0806709 - plastic trolley

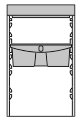

REF.	PCK	VOLUME (m <sup>3</sup> )	GROSS WEIGHT (kg)	SIZE (cm)
<b>MA0806709U000</b>	1	0,488	28,01	138x58x120
0000SE0104A	Blue plastic bucket 4 L with plastic handle	1 pc.		
0000SE0104B	Red plastic bucket 4 L with plastic handle	1 pc.		
0000SE0104C	Yellow plastic bucket 4 L with plastic handle	1 pc.		
0000SE0104F	Green plastic bucket 4 L with plastic handle	1 pc.		
0000SE1322A	TOP-DOWN® - blue plastic bucket 20 L with plastic handle and hermetic cover	1 pc.		
0000SM00165	Set of T-shaped light grey closing plugs for vertical frames (6 pcs)	2 pc.		
3048	Set of 3 stickers for buckets	1 pc.		
P066061U	Long base with wheels ø 125 mm	1 pc.		
P1229906U	Grey plastic sliding drawer drawer 22 L without locking key	1 pc.		
P2039903E	Vertical frame, 1 side with slides + 1 side for T-plugs, complete with screws and plugs	2 pc.		
P2199906U	Central plastic basket (female-female version) complete with caps	1 pc.		
P2909912U	Divider for bag holder 150 L	1 pc.		
P2909920U	Closing profile for central basket/bag holder complete with screws and plugs	1 pc.		
P2909946A	Blue cover for bag holder 150 L with check list holder	1 pc.		
P3059953E	Fixed side wall with fixing pins	3 pcs		
P3059954E	Right door with fixing pins	1 pc.		
P3909952E	Door with fixing pins for bag holder	1 pc.		
P8169905U	150l waste bag holder for Alpha standard and 90l for AlphaSplit, male fitting, with hooks, pistons, screws and plugs	1 pc.		
R1200042	Rilsan coated bucket holder for buckets 10 and 20 L fitting vertical frame Alpha line	1 pc.		

### ACCESSORIES TO ORDER AS SEPARATE ITEMS

0000AT0160A	Blue plastic-coated bag 57x98 cm, maximum capacity 80 L	1 pc.
0000AT0160B	Red plastic-coated bag 57x98 cm, capacity 80 L	1 pc.
P2909962U	Pedal set for Alpha trolleys with long base or compact, closed bag holder 150 L and wheels ø 125 mm	1 pc.
P320100UA	EQUODOSE - dosing device with one tank 6 L for mop soaking on demand	1 pc.

### ON REQUEST, WITH SURCHARGE

	Rubber wheels ø 125 mm	TROLLEY REF. <b>MA0803709U000</b>
	Wheels ø 100 mm	TROLLEY REF. <b>MA0801709U000</b>
	Bag holder with adjustable push-grip	TROLLEY REF. <b>MA0806759U000</b>

# Multipurpose trolleys



## ALPHA

## MORGAN

## CHROMED AND RILSAN COATED TROLLEYS

### ALPHA 3806710 - plastic trolley

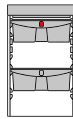

REF.	PCK	VOLUME (m <sup>3</sup> )	GROSS WEIGHT (kg)	SIZE (cm) ↓ ↓ ↓
<b>MA3806710U000</b>	1	0,488	31,44	136x58x110

0000SE0204UA	Grey plastic bucket 4 L with blue upper plastic handle	1 pc.
0000SE0204UB	Grey plastic bucket 4 L with red upper plastic handle	1 pc.
0000SE0204UC	Grey plastic bucket 4 L with yellow upper plastic handle	1 pc.
0000SE0204UF	Grey plastic bucket 4 L with green upper plastic handle	1 pc.
0000SE1322A	TOP-DOWN® - blue plastic bucket 20 L with plastic handle and hermetic cover	1 pc.
0000SM00165	Set of T-shaped light grey closing plugs for vertical frames (6 pcs)	2 pc.
3048	Set of 3 stickers for buckets	1 pc.
P066061U	Long base with wheels ø 125 mm	1 pc.
P075060U	Supporting plastic plate with 1 wheel ø 125 mm	1 pc.
P1229906U	Grey plastic sliding drawer drawer 22 L without locking key	1 pc.
P1909937U	Plastic lift for buckets, with holes for bottles, fitting drawers 22 and 40 L	1 pc.
P2039903E	Vertical frame, 1 side with slides + 1 side for T-plugs, complete with screws and plugs	2 pc.
P2229906U	Plastic sliding drawer 22 L with lock	1 pc.
P2909912U	Divider for bag holder 150 L	1 pc.
P2909920U	Closing profile for central basket/bag holder complete with screws and plugs	1 pc.
P2909946A	Blue cover for bag holder 150 L with check list holder	1 pc.
P3059953E	Fixed side wall with fixing pins	3 pcs
P3059954E	Right door with fixing pins	1 pc.
P3199903U	Central ring for 4l buckets complete with lockable grey lid and 2 pistons	1 pc.
P3909952E	Door with fixing pins for bag holder	1 pc.
P8169905U	150l waste bag holder for Alpha standard and 90l for AlphaSplit, male fitting, with hooks, pistons, screws and plugs	1 pc.

#### ACCESSORIES TO ORDER AS SEPARATE ITEMS

0000AT0160A	Blue plastic-coated bag 57x98 cm, maximum capacity 80 L	1 pc.
0000AT0160B	Red plastified bag 57x98 cm, capacity 80 L	1 pc.
P2909962U	Pedal set for Alpha trolleys with long base or compact, closed bag holder 150 L and wheels ø 125 mm	1 pc.
P320200UA	EQUODOSE- dosing device with two tanks 6 L for mop soaking on demand	1 pc.

#### ON REQUEST, WITH SURCHARGE

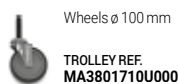

### ALPHA 3806711 - plastic trolley

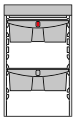

REF.	PCK	VOLUME (m <sup>3</sup> )	GROSS WEIGHT (kg)	SIZE (cm) ↓ ↓ ↓
<b>MA3806711U000</b>	1	0,488	35,64	153x58x110

0000SE0204UA	Grey plastic bucket 4 L with blue upper plastic handle	1 pc.
0000SE0204UB	Grey plastic bucket 4 L with red upper plastic handle	1 pc.
0000SE0204UC	Grey plastic bucket 4 L with yellow upper plastic handle	1 pc.
0000SE0204UF	Grey plastic bucket 4 L with green upper plastic handle	1 pc.
0000SE1322A	TOP-DOWN® - blue plastic bucket 20 L with plastic handle and hermetic cover	1 pc.
0000SE1322B	TOP-DOWN® - red plastic bucket 20 L with plastic handle and hermetic cover	1 pc.
0000SM00165	Set of T-shaped light grey closing plugs for vertical frames (6 pcs)	2 pc.
3048	Set of 3 stickers for buckets	1 pc.
P066061U	Long base with wheels ø 125 mm	1 pc.
P1229906U	Grey plastic sliding drawer drawer 22 L without locking key	1 pc.
P165001U	Plastic extension for Alpha base	1 pc.
P1909937U	Plastic lift for buckets, with holes for bottles, fitting drawers 22 and 40 L	1 pc.
P2039903E	Vertical frame, 1 side with slides + 1 side for T-plugs, complete with screws and plugs	2 pc.
P2229906U	Plastic sliding drawer 22 L with lock	1 pc.
P2909912U	Divider for bag holder 150 L	1 pc.
P2909920U	Closing profile for central basket/bag holder complete with screws and plugs	1 pc.
P2909946A	Blue cover for bag holder 150 L with check list holder	1 pc.
P3059953E	Fixed side wall with fixing pins	3 pcs
P3059954E	Right door with fixing pins	1 pc.
P3199903U	Central ring for 4l buckets complete with lockable grey lid and 2 pistons	1 pc.
P3909952E	Door with fixing pins for bag holder	1 pc.
P515060U	Supporting plastic plate with 2 wheels ø 125 mm and 2 blocking clips	1 pc.
P8169905U	150l waste bag holder for Alpha standard and 90l for AlphaSplit, male fitting, with hooks, pistons, screws and plugs	1 pc.

#### ACCESSORIES TO ORDER AS SEPARATE ITEMS

0000AT0160A	Blue plastic-coated bag 57x98 cm, maximum capacity 80 L	1 pc.
0000AT0160B	Red plastified bag 57x98 cm, capacity 80 L	1 pc.
P2909962U	Pedal set for Alpha trolleys with long base or compact, closed bag holder 150 L and wheels ø 125 mm	1 pc.
P320200UA	EQUODOSE- dosing device with two tanks 6 L for mop soaking on demand	1 pc.

#### ON REQUEST, WITH SURCHARGE





**ALPHA**

MORGAN

CHROMED AND RILSAN COATED TROLLEYS

## Components and accessories for Alpha trolleys

### Compact base for Alpha trolley



REF.	NOTES	SIZE (cm) ↓ ↓ ↓
P025011U	with wheels ø 100 mm	55x52
P025031U	with rubber wheels ø 125 mm	55x52
P025061U	with wheels ø 125 mm	55x52

### Short plastic base for Alpha trolley



REF.	NOTES	SIZE (cm) ↓ ↓ ↓
P059011U	with wheels ø 100 mm	66x52
P059031U	with rubber wheels ø 125 mm	66x52
P059061U	with wheels ø 125 mm	66x52

### Small base for Alpha Metal Free Trolley



REF.	NOTES	SIZE (cm) ↓ ↓ ↓
P059361UX	with rubber wheels ø 125 mm	66x52

### Long plastic base for Alpha trolley



REF.	NOTES	SIZE (cm) ↓ ↓ ↓
P066011U	with wheels ø 100 mm	91x52
P066031U	with rubber wheels ø 125 mm	91x52
P066061U	with wheels ø 125 mm	91x52

### Supporting plastic plate with 2 wheels and 2 blocking plugs



REF.	NOTES
P515010U	with wheels ø 100 mm
P515030U	with rubber wheels ø 125 mm
P515060U	with wheels ø 125 mm

### Blocking plug for supporting plastic plate



REF.	NOTES
P1901109U	

# Multipurpose trolleys



ALPHA

MORGAN

CHROMED AND RILSAN COATED TROLLEYS

Supporting plastic plate with 1 wheel



REF.	NOTES	SIZE (cm) ↓ ↓ ↓
P075060U	with wheel ø 125 mm	48x32x7

Supporting plastic plate for Alpha trolleys



REF.	NOTES	SIZE (cm) ↓ ↓ ↓
P175000U		48x32x7

Base extension for Alpha trolleys and for the bag supporting plastic plate of the Morgan Hotel Elegance trolleys



REF.	NOTES	SIZE (cm) ↓ ↓ ↓
P165000U		48x22x15

Plastic extension for Alpha base



REF.	NOTES
P165001U	

Vertical frame with reinforcement, 2 sides with T-plugs, complete with screws



REF.	NOTES
P2031102U	

For trolleys with foldable bagholder and side baskets

Vertical frame with reinforcement, 1 smooth side + 1 side for T-plugs, complete with screws



REF.	NOTES
P2031103U	



**ALPHA**

MORGAN

CHROMED AND RILSAN COATED TROLLEYS

Vertical frame, 1 side with slides + 1 side for T-plugs, complete with screws and plugs



REF.	NOTES
<b>P2039903E</b>	

Vertical frame, 1 side with slides + 1 side for T-plugs, complete with screws and plugs



REF.	NOTES
<b>P2039903EX</b>	

Vertical frame, 2 sides with slides, complete with screws and plugs



REF.	NOTES
<b>P2039904E</b>	

Vertical Frame, 1 smooth side + 1 side for T-plugs, complete with screws and plugs



REF.	NOTES
<b>P2039906E</b>	

Quick connection kit Link-Up to fix Alpha vertical frames



REF.	NOTES
<b>0000SM00617</b>	

MULTIPURPOSE  
TROLLEYS

# Multipurpose trolleys





ALPHA

MORGAN

CHROMED AND RILSAN COATED TROLLEYS

Set of T-shaped closing plugs for vertical frames (6 pcs)



REF.	NOTES
0000SM00163	dark grey 
0000SM00165	light grey 

Fixed side wall with fixing pins



REF.	NOTES
P3059953E	

Fixed side wall with fixing inserts for Alpha Metal Free trolley



REF.	NOTES
P3059953EX	

Right door with fixing pins



REF.	NOTES
P3059954E	

Right door with fixing pins for Alpha Metal Free



REF.	NOTES
P3059954EX	



**ALPHA**

MORGAN

CHROMED AND RILSAN COATED TROLLEYS

Left door with fixing pins



REF.	NOTES
<b>P3059974E</b>	

Door for 150l waste bag holder with fastening pins



REF.	NOTES
<b>P3909952E</b>	

Set right and left walls for AlphaSplit



REF.	NOTES
<b>P3059967E</b>	

Door for AlphaSplit bag holder



REF.	NOTES
<b>P2059963E</b>	

Central plastic basket (female-female version) complete with caps



REF.	NOTES
<b>P2199906U</b>	internal dimension 48x31x8 cm

MULTIPURPOSE TROLLEYS



# Multipurpose trolleys



ALPHA

MORGAN

CHROMED AND RILSAN COATED TROLLEYS











Central plastic basket (male-female version) complete with screws and caps



REF.	NOTES
P2199907U	internal dimension 48x31x8 cm

Central ring for 4l buckets complete with lockable coloured lid, 2 soft-close pistons and 2 short supports for hooks and clips



REF.	NOTES
P3199903U	for trolleys with fixed side wall 
P3199903UA	for trolleys with fixed side wall 
P3199903UB	for trolleys with fixed side wall 
P3199903UC	for trolleys with fixed side wall 
P3199903UF	for trolleys with fixed side wall 
P4199903U	for trolleys without fixed side wall 
P4199903UA	for trolleys without fixed side wall 
P4199903UB	for trolleys without fixed side wall 
P4199903UC	for trolleys without fixed side wall 
P4199903UF	for trolleys without fixed side wall 



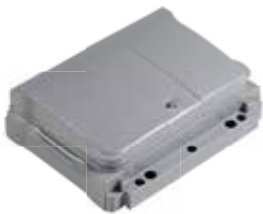

Central ring for 4l buckets for Alpha Metal Free trolley complete with lockable coloured lid, 2 soft-close pistons and 2 short supports for hooks and clips



REF.	NOTES
P3199903UX	for trolleys with fixed side wall 

Central ring for 8l buckets complete with lockable coloured lid, 2 soft-close pistons and 2 short supports for hooks and clips



REF.	NOTES
P3199905U	
P3199905UA	
P3199905UB	
P3199905UC	
P3199905UF	

Side plastic basket



REF.	NOTES
P1191100U	external dimension 49x22x11,5 cm



**ALPHA**

MORGAN

CHROMED AND RILSAN COATED TROLLEYS



Plastic rising support for basket art. P1191100U

REF.	NOTES
<b>P190112U</b>	







Upper basket



REF.	NOTES
<b>P1199900U</b>	internal dimension 49,5x14x11 cm

Closing profile for central basket/bag holder complete with screws and plugs



REF.	NOTES
<b>P2909920U</b>	

Closing profile for central basket/bag holder complete with screws and plugs for Alpha Metal Free trolley

REF.	NOTES
<b>P2909920UX</b>	

Closing profile with push-grip for central basket complete with screws and plugs

REF.	NOTES
<b>P2909921U</b>	

Closing profile with push-grip for central basket complete with screws and plugs for Alpha Metal Free trolley

REF.	NOTES
<b>P2909921UX</b>	

MULTIPURPOSE TROLLEYS

# Multipurpose trolleys



ALPHA

MORGAN

CHROMED AND RILSAN COATED TROLLEYS

Closing profile for vertical frame complete with screws and plugs



REF.	NOTES
<b>P2909960U</b>	

Covering



REF.	NOTES
<b>P1909967U</b>	for fixed bag holder 120 L
<b>P1909968U</b>	for bag holder 150 L, foldable bag holder 120 L and profile

120l waste bag holder, with 2 fixed dustpan hooks, 2 handle clips and 2 Uni-Move clips



REF.	NOTES
<b>P8161110U</b>	female version
<b>P8161111U</b>	male version

120l waste bag holder for Alpha Metal Free trolley, with 2 fixed dustpan hooks, 2 handle clips and 2 Uni-Move clips



REF.	NOTES
<b>P8161111UX</b>	male version

120l waste bag holder with tray, with 2 fixed dustpan hooks, 2 handle clips, 2 Uni-Move clips, screws and plugs



REF.	NOTES
<b>P8161112U</b>	

Folding 120l waste bag holder, with bag retaining hooks, 2 fixed dustpan hooks, 1 handle clip, 2 Uni-Move clips, screws and plugs



REF.	NOTES
<b>P8161113U</b>	
<b>P8161115U</b>	for trolleys with central frame



**ALPHA**

MORGAN

CHROMED AND RILSAN COATED TROLLEYS

150l waste bag holder, with 2 Uni-Move clips, 2 long supports with sign hook, 2 pistons, screws and plugs for Alpha 7103 trolley



REF.	NOTES
<b>P8169900U</b>	female version
<b>P8169901U</b>	male version

150l waste bag holder for Alpha standard and 90l for AlphaSplit, male fitting, with 2 Uni-Move clips, 2 long supports with sign hook, 2 pistons, screws and plugs



REF.	NOTES
<b>P8169905U</b>	

150l waste bag holder for Alpha standard and 90l for AlphaSplit, with adjustable push handle, male fitting, with 2 Uni-Move clips, 2 long supports with sign hook, 2 pistons, screws and plugs



REF.	NOTES
<b>P8269907U</b>	

Central bag holder 150 L



REF.	NOTES
<b>P8169903U</b>	female/female version
<b>P8169904U</b>	male / female version

Set of 2 bag holders 150 L complete with screws and plugs



REF.	NOTES
<b>P8169906U</b>	

Rilsan 70l waste bag holder for mounting on vertical frame



REF.	NOTES
<b>R2060031</b>	

**NEW**

# Multipurpose trolleys



ALPHA

MORGAN

CHROMED AND RILSAN COATED TROLLEYS

## Divider for plastic bag holder 120 L



REF.	NOTES
P206020U	2x60 L
P206030U	1x40 L + 1x80 L
P206040U	3x40 L

## Plastic divider with square shaped insert for bag holder 120 L



REF.	NOTES
P306020U	2x60 L and 20 L square shaped insert
P406020U	2x60 L and two 20 L square shaped inserts

For Alpha, Emotion range bag holders and bag holder code P906010U, Morgan range

## Square plastic support 20 L for the divider of bag holder 120 L



REF.	NOTES
P1909957U	

For Alpha, Emotion range bag holders and bag holder code P906010U, Morgan range - Use recommended with net bags, code 0000AT0210

## Divider for bag holder 150 L



REF.	NOTES
P2909912U	

## Square plastic support 20 L for bag holder 150 L



REF.	NOTES
P1909926U	with right connection
P1909927U	with left connection

It is suggested the use of the specific net bags for washing art. 0000AT0210

## Plastic divider 3x20 L for bag holder 150 L



REF.	NOTES
P1909914U	

It is suggested the use of the specific net bags for washing art. 0000AT0210



**ALPHA**

MORGAN

CHROMED AND RILSAN COATED TROLLEYS

Stainless steel holder for buckets 4 L for bag holder 150 L



REF.	NOTES
<b>I1050072</b>	

**DUO PRO kit**

**NEW**



REF.	NOTES
<b>0020SE2742U</b>	
0000SE0717UA	17l plastic mop bucket, grey with blue handle 1 pc.
0000SE0725UB	25l mop bucket with handle, grey with red handle 1 pc.
21040U	DUO PRO - lever plastic wringer 1 pc.
P165002U	Base extension for Duo Pro system 1 pc.
P1901123U	Spacer for Duo Pro system 2 pc.



**HANDY - bin 70 L with drain plug, wheels, bag stretcher, grip and cover**



REF.	NOTES	SIZE (cm) ↓ ↓ ↓
<b>0000C06170E</b>		51,5x56x86

**HANDY - bin 70 L with drain plug, wheels, bag stretcher and grip**



REF.	NOTES	SIZE (cm) ↓ ↓ ↓
<b>P391070E</b>		51,5x56x86

**HANDY - bin 70 L with drain plug, wheels and bag stretcher**



REF.	NOTES	SIZE (cm) ↓ ↓ ↓
<b>P291070E</b>		37x56x71

MULTIPURPOSE TROLLEYS

# Multipurpose trolleys



ALPHA

MORGAN

CHROMED AND RILSAN COATED TROLLEYS

Cover set complete with rubber lace, cage for deodorant pills and screws



REF.	NOTES
P290068E	

Assembling kit to fix Handy bin to Alpha vertical frame



REF.	NOTES
0000SM00610	

Plastic shelf for AlphaSplit



REF.	NOTES
P2229914U	

Sliding plastic drawer 33L with lock for AlphaSplit



REF.	NOTES	CAPACITY (L)
P2229913U	interior dimensions 34x41x24 cm	33

Bag holder insert with storage compartment for AlphaSplit



REF.	NOTES
P1909966U	

Bag holder insert with storage compartment and one divider for AlphaSplit



REF.	NOTES
P2909966U	



ALPHA

MORGAN

CHROMED AND RILSAN COATED TROLLEYS

Bag holder insert with storage compartment and two dividers for AlphaSplit



REF.	NOTES
<b>P3909966U</b>	

Set of plastic shelves (2 pcs)

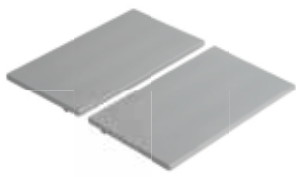

REF.	NOTES	SIZE (cm) ↓ ↓ ↓
<b>P1229900U</b>		21,5x37,5x1,5

Plastic sliding drawer without locking key



REF.	NOTES	CAPACITY (L)	SIZE (cm) ↓ ↓ ↓
<b>P1229909U</b>	internal dimensions 41x34x9,5 cm	10	46,5x37,5x11
<b>P1229906U</b>	internal dimensions 40,5x34x16 cm	22	46,5x37,5x17
<b>P1229907U</b>	internal dimensions 40x34x33,5 cm	40	46,5x37,5x35

Plastic sliding drawer with locking key



REF.	NOTES	CAPACITY (L)	SIZE (cm) ↓ ↓ ↓
<b>P2229909U</b>	internal dimensions 41x34x9,5 cm	10	46,5x37,5x11
<b>P2229906A</b>	internal dimensions 40,5x34x16 cm	22	46,5x37,5x17
<b>P2229906B</b>	internal dimensions 40,5x34x16 cm	22	46,5x37,5x17
<b>P2229906U</b>	internal dimensions 40,5x34x16 cm	22	46,5x37,5x17
<b>P2229907U</b>	internal dimensions 40x34x33,5 cm	40	46,5x37,5x35

Plastic sliding drawer without lock for Alpha Metal Free trolley



REF.	NOTES	CAPACITY (L)	SIZE (cm) ↓ ↓ ↓
<b>P1229906UX</b>	internal dimensions 40,5x34x16 cm	22	46,5x37,5x17
<b>P1229907UX</b>	internal dimensions 40x34x33,5 cm	40	46,5x37,5x35

Plastic sliding drawer with lock for Alpha Metal Free trolley



REF.	NOTES	CAPACITY (L)	SIZE (cm) ↓ ↓ ↓
<b>P2229906UX</b>	internal dimensions 40,5x34x16 cm	22	46,5x37,5x17
<b>P2229907UX</b>	internal dimensions 40x34x33,5 cm	40	46,5x37,5x35



# Multipurpose trolleys



ALPHA

MORGAN

CHROMED AND RILSAN COATED TROLLEYS

Plastic sliding tray with slide out limiter and key



REF.	NOTES
<b>P3229915U</b>	

Set of 1 big divider 39 cm + 1 medium divider 32 cm for plastic sliding drawer 22 L

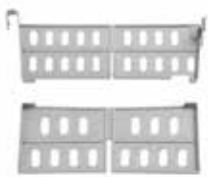

REF.	NOTES
<b>0000SM00213U</b>	

Set of 1 big divider 39 cm + 3 small dividers 16 cm for plastic sliding drawer 22 L



REF.	NOTES
<b>0000SM00214U</b>	

Plastic divider for drawer 10 L



REF.	NOTES
<b>0000SM00227D</b>	9 compartments
<b>0000SM00228D</b>	12 compartments

Pierced plastic sieve for mop soaking fitting drawers 10, 22 and 40 L



REF.	NOTES	PCK	VOLUME (m³)	GROSS WEIGHT (kg)
<b>P1909925U</b>		10	0,038	5,69

Ideal for a uniform distribution of the cleaning solution - For a quick pre-soaking (max 15 minutes)

Pierced plastic sieve with high border for mop soaking fitting drawers 10, 22 and 40 L



REF.	NOTES
<b>P1909961U</b>	

Ideal for a uniform distribution of the cleaning solution - For a quick pre-soaking (max 15 minutes)



**ALPHA**

MORGAN

CHROMED AND RILSAN COATED TROLLEYS

Plastic cover for drawers 10, 22 and 40 L

REF.	NOTES	PCK	VOLUME (m³)	GROSS WEIGHT (kg)
<b>P1909933U</b>		10	0,038	7,21



Plastic lift for buckets, with holes for bottles, fitting drawers 22 and 40 L



REF.	NOTES
<b>P1909937U</b>	

Pedal set for Alpha long or mini base and bag holder 150 L



REF.	NOTES
<b>P2909915U</b>	for base with wheels ø 100 mm
<b>P2909918U</b>	for base with rubber wheels ø 125 mm
<b>P2909962U</b>	for base with wheels ø 125 mm



Pedal set for Alpha trolleys with short base and closed bag holder 150 L



REF.	NOTES
<b>P3909915U</b>	for base with wheels ø 100 mm
<b>P3909918U</b>	for base with rubber wheels ø 125 mm
<b>P3909962U</b>	for base with wheels ø 125 mm

Plastic cover for bag holder 120 L





REF.	NOTES
<b>P291918A</b>	
<b>P291918B</b>	



Please, require also no. 2 shock absorbing pistons art. P190908U for a perfect soft closing

Plastic cover for bag holder 120 L with check-list holder



REF.	NOTES
<b>P291919A</b>	
<b>P291919B</b>	
<b>P291919T</b>	



Please, require also no. 2 shock absorbing pistons art. P190908U for a perfect soft closing

# Multipurpose trolleys



ALPHA

MORGAN

CHROMED AND RILSAN COATED TROLLEYS

Plastic cover for bag holder 120 L with storage room, check-list holder and lock

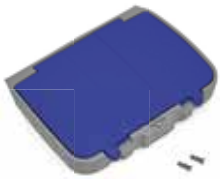

REF.	NOTES
P291920UA	
P291920UB	
P291920U	



Please, require also no. 2 shock absorbing pistons art. P190908U for a perfect soft closing

Plastic cover for bag holder 150 L with check-list holder



REF.	NOTES
P2909946A	
P2909946B	



Please, require also no. 2 shock absorbing pistons art. P190908U for a perfect soft closing

Plastic cover for bag holder 150 L with check-list holder, storage room and removable locking key



REF.	NOTES
P2909955A	
P2909955B	



Please, require also no. 4 shock absorbing pistons art. P190908U for a perfect soft closing

Plastic cover for bag holder 150 L with check-list holder, storage room and removable double locking key



REF.	NOTES
P3909955A	
P3909955B	



Please, require also no. 4 shock absorbing pistons art. P190908U for a perfect soft closing

Plastic cover for central bag holder 150 L



REF.	NOTES
P2919943U	



Please, require also no. 2 shock absorbing pistons art. P190908U for a perfect soft closing

Plastic lid for 70l waste bag holder



REF.	NOTES
P190916A	



**ALPHA**

MORGAN

CHROMED AND RILSAN COATED TROLLEYS

Shock absorbing piston for a soft closing of the cover



REF.	NOTES
<b>P190908U</b>	



Rilsan coated wringer support complete with screws



REF.	NOTES
<b>R1040010</b>	

Rilsan coated fixing set for Fred trolley



REF.	NOTES
<b>0000SM00606</b>	

Plastic bin 12 L with metal handle and cover with locking key



REF.	NOTES	SIZE (cm) ↓ ↓ ↓
<b>0000C02012U</b>		26x21x36

Thanks to its locking key, it is possible to transport chemical and/or toxic products inside the bin safely

Square Rilsan trolley with 200mm ø wheels, plastic support, trolley retaining set and Bis hook, for 10- and 20-litre Top-Down|a|l|a| buckets



REF.	NOTES	SIZE (cm) ↓ ↓ ↓
<b>R3030133</b>		60x32x94

Fitting Alpha trolleys

Rilsan coated bucket holder for buckets 10 and 20 L fitting Morgan vertical frame and Alpha trolley



REF.	NOTES
<b>R2200040</b>	

# Multipurpose trolleys



ALPHA

MORGAN

CHROMED AND RILSAN COATED TROLLEYS

Rilsan coated bucket holder for buckets 10 and 20 L fitting vertical frame Alpha line



REF.	NOTES
R1200042	

POCKET - foldable metal trolley for Top-Down® buckets 10 and 20 L



REF.	NOTES
V2030122	

Plastic mop holder fitting Alpha base



REF.	NOTES
P1909948U	

Tablet holder support for the Alpha vertical frame

**NEW**



REF.	NOTES
0000SM00401	

Floor scrubber platform kit

**NEW**



REF.	NOTES
0000SM00635	For trolleys with ø 100 mm wheels
0000SM00645	For trolleys with ø 125 mm wheels

PEG KIT - kit for attaching OneFred on Alpha trolleys complete with mop holder

**NEW**



REF.	NOTES
0000SM00298	



MULTIPURPOSE  
TROLLEYS



**ALPHA**

MORGAN

CHROMED AND RILSAN COATED TROLLEYS

**PEG KIT - kit for attaching OneFred on Alpha trolleys**

**NEW**

REF.	NOTES
<b>000SM00301</b>	



**Lithium battery for Drive trolleys**

**NEW**



REF.	NOTES
<b>00BL1000</b>	

# Multipurpose trolleys



ALPHA

**MORGAN**

CHROMED AND RILSAN COATED TROLLEYS

## Collection and storage line

### MORGAN 1000 - plastic trolley



### MORGAN 2050 - plastic trolley



REF.	PCK	VOLUME (m³)	GROSS WEIGHT (kg)	SIZE (cm)
<b>0000MP1000A</b>	1	0,191	15,46	96x61x109
0000SM00115U	FLIP - handle holder with rubber roll and snap closure fitting tubes Ø 22 mm			1 pc.
8218A	Blue plastic bucket 6 L with plastic handle			1 pc.
8218B	Red plastic bucket 6 L with plastic handle			1 pc.
P119002A	Blue side plastic basket for Morgan trolley			2 pc.
P202001A	Short plastic base with wheels ø 100 mm and bumpers for Morgan trolley			1 pc.
P816010U	Plastic bag holder 120 L with push-bar, bag-stretchers and reinforcements			1 pc.
R1030010	Rilsan coated vertical frame complete with screws for Morgan trolley			1 pc.

#### ACCESSORIES TO ORDER AS SEPARATE ITEMS

3650A	Blue plastified bag 73x97,5 cm, capacity 120 L	1 pc.
P291920UA	Blue plastic cover for bag holder 120 L with storage room, check-list holder and lock	1 pc.

#### ON REQUEST, WITH SURCHARGE



REF.	PCK	VOLUME (m³)	GROSS WEIGHT (kg)	SIZE (cm)
<b>0000MP2050A</b>	1	0,191	17,98	96x61x104
0000SM00115U	FLIP - handle holder with rubber roll and snap closure fitting tubes Ø 22 mm			1 pc.
P119001A	Blue small central plastic basket for Morgan trolley			2 pc.
P202001A	Short plastic base with wheels ø 100 mm and bumpers for Morgan trolley			1 pc.
P816010U	Plastic bag holder 120 L with push-bar, bag-stretchers and reinforcements			1 pc.
R1030010	Rilsan coated vertical frame complete with screws for Morgan trolley			2 pc.

#### ACCESSORIES TO ORDER AS SEPARATE ITEMS

3650A	Blue plastified bag 73x97,5 cm, capacity 120 L	1 pc.
P291920UA	Blue plastic cover for bag holder 120 L with storage room, check-list holder and lock	1 pc.

#### ON REQUEST, WITH SURCHARGE





ALPHA

MORGAN

CHROMED AND RILSAN COATED TROLLEYS

## MORGAN 3000 - plastic trolley



REF.	PCK	VOLUME (m³)	GROSS WEIGHT (kg)	SIZE (cm) ↓ ↓ ↓
<b>0000MP3000A</b>	1	0,251	21,99	110x61x107
0000SM00115U	FLIP - handle holder with rubber roll and snap closure fitting tubes Ø22 mm			1 pc.
3048	Set of 3 stickers for buckets			1 pc.
8218A	Blue plastic bucket 6 L with plastic handle			1 pc.
8218B	Red plastic bucket 6 L with plastic handle			1 pc.
8218C	Yellow plastic bucket 6 L with plastic handle			1 pc.
8218F	Green plastic bucket 6 L with plastic handle			1 pc.
P119003A	Blue big central plastic basket with 6 hooks			2 pc.
P202050A	Long plastic base with 5 wheels ø 100 mm and bumpers for Morgan trolley			1 pc.
P816010U	Plastic bag holder 120 L with push-bar, bag-stretchers and reinforcements			1 pc.
R1030010	Rilsan coated vertical frame complete with screws for Morgan trolley			2 pc.

### ACCESSORIES TO ORDER AS SEPARATE ITEMS

3650A	Blue plastified bag 73x97,5 cm, capacity 120 L	1 pc.
P291920UA	Blue plastic cover for bag holder 120 L with storage room, check-list holder and lock	1 pc.

### ON REQUEST, WITH SURCHARGE

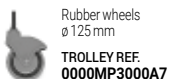

## Wet mopping line

## MORGAN 1040 - plastic trolley



REF.	PCK	VOLUME (m³)	GROSS WEIGHT (kg)	SIZE (cm) ↓ ↓ ↓
<b>0000MP1040A</b>	1	0,261	20,75	129x67x113
0000SM00115U	FLIP - handle holder with rubber roll and snap closure fitting tubes Ø22 mm			1 pc.
7004A	REGULAR - blue plastic down-press wringer with plastic gears			1 pc.
8108A	Blue plastic bucket 15 L with plastic handle			1 pc.
8108B	Red plastic bucket 15 L with plastic handle			1 pc.
8218A	Blue plastic bucket 6 L with plastic handle			1 pc.
8218B	Red plastic bucket 6 L with plastic handle			1 pc.
P074000A	Blue supporting plastic plate fitting Morgan base			1 pc.
P119002A	Blue side plastic basket for Morgan trolley			2 pc.
P202001A	Short plastic base with wheels ø 100 mm and bumpers for Morgan trolley			1 pc.
P816010U	Plastic bag holder 120 L with push-bar, bag-stretchers and reinforcements			1 pc.
R1030010	Rilsan coated vertical frame complete with screws for Morgan trolley			1 pc.
R1040010	Rilsan coated wringer support complete with screws			1 pc.

### ACCESSORIES TO ORDER AS SEPARATE ITEMS

3650A	Blue plastified bag 73x97,5 cm, capacity 120 L	1 pc.
P291920UA	Blue plastic cover for bag holder 120 L with storage room, check-list holder and lock	1 pc.

### ON REQUEST, WITH SURCHARGE





# Multipurpose trolleys



ALPHA

MORGAN

CHROMED AND RILSAN COATED TROLLEYS

## MORGAN 1050 - plastic trolley



## MORGAN 1060 - plastic trolley



REF.	PCK	VOLUME (m³)	GROSS WEIGHT (kg)	SIZE (cm) ↓ ↓ ↓
<b>0000MP1050A</b>	1	0,261	19,37	96x67x113
0000SM00115U	FLIP - handle holder with rubber roll and snap closure fitting tubes Ø 22 mm			1 pc.
7004A	REGULAR - blue plastic down-press wringer with plastic gears			1 pc.
8108A	Blue plastic bucket 15 L with plastic handle			1 pc.
8108B	Red plastic bucket 15 L with plastic handle			1 pc.
8218A	Blue plastic bucket 6 L with plastic handle			1 pc.
8218B	Red plastic bucket 6 L with plastic handle			1 pc.
P119002A	Blue side plastic basket for Morgan trolley			1 pc.
P202001A	Short plastic base with wheels ø 100 mm and bumpers for Morgan trolley			1 pc.
P816010U	Plastic bag holder 120 L with push-bar, bag-stretchers and reinforcements			1 pc.
R1030125	Rilsan coated shaped vertical frame for Morgan trolley art. 0000MP1050A			1 pc.
R1040010	Rilsan coated wringer support complete with screws			1 pc.

### ACCESSORIES TO ORDER AS SEPARATE ITEMS

3650A	Blue plastified bag 73x97,5 cm, capacity 120 L	1 pc.
P291920UA	Blue plastic cover for bag holder 120 L with storage room, check-list holder and lock	1 pc.

### ON REQUEST, WITH SURCHARGE



REF.	PCK	VOLUME (m³)	GROSS WEIGHT (kg)	SIZE (cm) ↓ ↓ ↓
<b>0000MP1060A</b>	1	0,261	20,75	106x67x113
0000SM00115U	FLIP - handle holder with rubber roll and snap closure fitting tubes Ø 22 mm			1 pc.
7004A	REGULAR - blue plastic down-press wringer with plastic gears			1 pc.
8108A	Blue plastic bucket 15 L with plastic handle			1 pc.
8108B	Red plastic bucket 15 L with plastic handle			1 pc.
8218A	Blue plastic bucket 6 L with plastic handle			1 pc.
8218B	Red plastic bucket 6 L with plastic handle			1 pc.
P119002A	Blue side plastic basket for Morgan trolley			2 pc.
P202001A	Short plastic base with wheels ø 100 mm and bumpers for Morgan trolley			1 pc.
P816010U	Plastic bag holder 120 L with push-bar, bag-stretchers and reinforcements			1 pc.
R1030010	Rilsan coated vertical frame complete with screws for Morgan trolley			1 pc.
R1040010	Rilsan coated wringer support complete with screws			1 pc.

### ACCESSORIES TO ORDER AS SEPARATE ITEMS

3650A	Blue plastified bag 73x97,5 cm, capacity 120 L	1 pc.
P291920UA	Blue plastic cover for bag holder 120 L with storage room, check-list holder and lock	1 pc.

### ON REQUEST, WITH SURCHARGE





ALPHA

**MORGAN**

CHROMED AND RILSAN COATED TROLLEYS

**MORGAN 2010** - plastic trolley



**MORGAN 2150** - plastic trolley

**NEW**



**OneFred  
NOT INCLUDED**

REF.	PCK	VOLUME (m³)	GROSS WEIGHT (kg)	SIZE (cm) ↓ ↓ ↓
<b>0000MP2010A</b>	1	0,261	23,84	129x67x113
0000SM00115U	FLIP - handle holder with rubber roll and snap closure fitting tubes Ø22 mm			1 pc.
7004A	REGULAR - blue plastic down-press wringer with plastic gears			1 pc.
8108A	Blue plastic bucket 15 L with plastic handle			1 pc.
8108B	Red plastic bucket 15 L with plastic handle			1 pc.
8211/1A	Blue plastic bucket 12 L with plastic handle			1 pc.
8211/1B	Red plastic bucket 12 L with plastic handle			1 pc.
P074000A	Blue supporting plastic plate fitting Morgan base			1 pc.
P119001A	Blue small central plastic basket for Morgan trolley			2 pc.
P202001A	Short plastic base with wheels ø 100 mm and bumpers for Morgan trolley			1 pc.
P816010U	Plastic bag holder 120 L with push-bar, bag-stretchers and reinforcements			1 pc.
R1030010	Rilsan coated vertical frame complete with screws for Morgan trolley			2 pc.
R1040010	Rilsan coated wringer support complete with screws			1 pc.

**ACCESSORIES TO ORDER AS SEPARATE ITEMS**

3650A	Blue plastified bag 73x97,5 cm, capacity 120 L	1 pc.
P291920UA	Blue plastic cover for bag holder 120 L with storage room, check-list holder and lock	1 pc.

**ON REQUEST, WITH SURCHARGE**



REF.	PCK	VOLUME (m³)	GROSS WEIGHT (kg)	SIZE (cm) ↓ ↓ ↓
<b>0000MP2150A</b>	1	0,191	18,98	96x61x113

**Complete trolley sizes with OneFred 148 x65x113 cm**

0000SM00115U	FLIP - handle holder with rubber roll and snap closure fitting tubes Ø22 mm	1 pc.
8211/1A	Blue plastic bucket 12 L with plastic handle	1 pc.
8211/1B	Red plastic bucket 12 L with plastic handle	1 pc.
P119001A	Blue small central plastic basket for Morgan trolley	2 pc.
P202001A	Short plastic base with wheels ø 100 mm and bumpers for Morgan trolley	1 pc.
P816010U	Plastic bag holder 120 L with push-bar, bag-stretchers and reinforcements	1 pc.
R1030010	Rilsan coated vertical frame complete with screws for Morgan trolley	2 pc.

**ACCESSORIES TO ORDER AS SEPARATE ITEMS**

0000LF0030YU	ONEFRED - 30 l plastic trolley with plastic handle	1 pc.
0000SM00297	PEG KIT - OneFred attachment kit for Morgan trolleys with broom holder	1 pc.
3650A	Blue plastified bag 73x97,5 cm, capacity 120 L	1 pc.
P291920UA	Blue plastic cover for bag holder 120 L with storage room, check-list holder and lock	1 pc.

**ON REQUEST, WITH SURCHARGE**



# Multipurpose trolleys



ALPHA

MORGAN

CHROMED AND RILSAN COATED TROLLEYS

## MORGAN 3010 - plastic trolley



## MORGAN 3060 - plastic trolley



REF.	PCK	VOLUME (m³)	GROSS WEIGHT (kg)	SIZE (cm) ↓ ↓ ↓
<b>0000MP3010A</b>	1	0,261	23,09	143x67x107
0000SM00115U	FLIP - handle holder with rubber roll and snap closure fitting tubes Ø 22 mm			1 pc.
3048	Set of 3 stickers for buckets			1 pc.
7004A	REGULAR - blue plastic down-press wringer with plastic gears			1 pc.
8108A	Blue plastic bucket 15 L with plastic handle			1 pc.
8108B	Red plastic bucket 15 L with plastic handle			1 pc.
8218A	Blue plastic bucket 6 L with plastic handle			1 pc.
8218B	Red plastic bucket 6 L with plastic handle			1 pc.
8218C	Yellow plastic bucket 6 L with plastic handle			1 pc.
8218F	Green plastic bucket 6 L with plastic handle			1 pc.
P074000A	Blue supporting plastic plate fitting Morgan base			1 pc.
P119003A	Blue big central plastic basket with 6 hooks			2 pc.
P202050A	Long plastic base with 5 wheels ø 100 mm and bumpers for Morgan trolley			1 pc.
P816010U	Plastic bag holder 120 L with push-bar, bag-stretchers and reinforcements			1 pc.
R1030010	Rilsan coated vertical frame complete with screws for Morgan trolley			2 pc.
R1040010	Rilsan coated wringer support complete with screws			1 pc.

### ACCESSORIES TO ORDER AS SEPARATE ITEMS

3650A	Blue plastified bag 73x97,5 cm, capacity 120 L	1 pc.
P291920UA	Blue plastic cover for bag holder 120 L with storage room, check-list holder and lock	1 pc.

### ON REQUEST, WITH SURCHARGE



REF.	PCK	VOLUME (m³)	GROSS WEIGHT (kg)	SIZE (cm) ↓ ↓ ↓
<b>0000MP3060A</b>	1	0,307	26,28	143x63x107
0000SM00113U	Handle holder with snap closure for tubes ø 22 mm			2 pc.
0000SM00115U	FLIP - handle holder with rubber roll and snap closure fitting tubes Ø 22 mm			2 pc.
3048	Set of 3 stickers for buckets			1 pc.
3641A	Plastic basin 35 L			1 pc.
3642	Pierced plastic sieve for basin 35 L			1 pc.
8218A	Blue plastic bucket 6 L with plastic handle			1 pc.
8218B	Red plastic bucket 6 L with plastic handle			1 pc.
8218C	Yellow plastic bucket 6 L with plastic handle			1 pc.
8218F	Green plastic bucket 6 L with plastic handle			1 pc.
P074000A	Blue supporting plastic plate fitting Morgan base			1 pc.
P119003A	Blue big central plastic basket with 6 hooks			2 pc.
P202050A	Long plastic base with 5 wheels ø 100 mm and bumpers for Morgan trolley			1 pc.
P516010U	Plastic bag holder 2x60 L with push-bar, bag-stretchers and reinforcements			1 pc.
R1030010	Rilsan coated vertical frame complete with screws for Morgan trolley			2 pc.

### ACCESSORIES TO ORDER AS SEPARATE ITEMS

0000AT0170A	Blue plastified bag 48x95 cm, capacity 60 L	1 pc.
0000AT0170B	Red plastic-coated bag 48x95 cm, maximum capacity 60 L	1 pc.
P291920UA	Blue plastic cover for bag holder 120 L with storage room, check-list holder and lock	1 pc.

### ON REQUEST, WITH SURCHARGE





ALPHA

MORGAN

CHROMED AND RILSAN COATED TROLLEYS

## MORGAN 3080 - plastic trolley



## MORGAN 4010 - plastic trolley



REF.	PCK	VOLUME (m³)	GROSS WEIGHT (kg)	SIZE (cm)
<b>0000MP3080A</b>	1	0,261	20,87	110x67x109
0000SM00115U	FLIP - handle holder with rubber roll and snap closure fitting tubes Ø 22 mm			1 pc.
7004A	REGULAR - blue plastic down-press wringer with plastic gears			1 pc.
8108A	Blue plastic bucket 15 L with plastic handle			1 pc.
8108B	Red plastic bucket 15 L with plastic handle			1 pc.
8218A	Blue plastic bucket 6 L with plastic handle			1 pc.
8218B	Red plastic bucket 6 L with plastic handle			1 pc.
P119002A	Blue side plastic basket for Morgan trolley			1 pc.
P202050A	Long plastic base with 5 wheels ø 100 mm and bumpers for Morgan trolley			1 pc.
P816010U	Plastic bag holder 120 L with push-bar, bag-stretchers and reinforcements			1 pc.
R1030010	Rilsan coated vertical frame complete with screws for Morgan trolley			1 pc.
R1040010	Rilsan coated wringer support complete with screws			1 pc.

### ACCESSORIES TO ORDER AS SEPARATE ITEMS

0000PA0101C	Plastic board complete with fixing clamp ø 22 mm	1 pc.
3650A	Blue plastified bag 73x97,5 cm, capacity 120 L	1 pc.
P219007U	Plastic basket complete with 3 dividers fitting vertical frame Morgan trolley art. 0000MP3080A	1 pc.
P291920UA	Blue plastic cover for bag holder 120 L with storage room, check-list holder and lock	1 pc.

### ON REQUEST, WITH SURCHARGE



REF.	PCK	VOLUME (m³)	GROSS WEIGHT (kg)	SIZE (cm)
<b>0000MP4010A</b>	1	0,298	29,69	143x67x107
0000SM00115U	FLIP - handle holder with rubber roll and snap closure fitting tubes Ø 22 mm			1 pc.
3048	Set of 3 stickers for buckets			1 pc.
7004A	REGULAR - blue plastic down-press wringer with plastic gears			1 pc.
8108A	Blue plastic bucket 15 L with plastic handle			1 pc.
8108B	Red plastic bucket 15 L with plastic handle			1 pc.
8218A	Blue plastic bucket 6 L with plastic handle			1 pc.
8218B	Red plastic bucket 6 L with plastic handle			1 pc.
8218C	Yellow plastic bucket 6 L with plastic handle			1 pc.
8218F	Green plastic bucket 6 L with plastic handle			1 pc.
P074000A	Blue supporting plastic plate fitting Morgan base			1 pc.
P119003A	Blue big central plastic basket with 6 hooks			2 pc.
P1220203E	Plastic cabinet with locking key for Morgan trolley			1 pc.
P202050A	Long plastic base with 5 wheels ø 100 mm and bumpers for Morgan trolley			1 pc.
P516010U	Plastic bag holder 2x60 L with push-bar, bag-stretchers and reinforcements			1 pc.
R1030137	Rilsan coated vertical frame for Morgan trolley art. 0000MP4010A			2 pc.
R1040010	Rilsan coated wringer support complete with screws			1 pc.

### ACCESSORIES TO ORDER AS SEPARATE ITEMS

0000AT0170A	Blue plastified bag 48x95 cm, capacity 60 L	1 pc.
0000AT0170B	Red plastic-coated bag 48x95 cm, maximum capacity 60 L	1 pc.
P291920UA	Blue plastic cover for bag holder 120 L with storage room, check-list holder and lock	1 pc.

### ON REQUEST, WITH SURCHARGE



# Multipurpose trolleys



ALPHA

MORGAN

CHROMED AND RILSAN COATED TROLLEYS

## Top-Down® line

### MORGAN TOP-DOWN® MIDI 8010 - plastic trolley



### MORGAN TOP-DOWN® MAXI 8020 - plastic trolley



REF.	PCK	VOLUME (m³)	GROSS WEIGHT (kg)	SIZE (cm) ↓ ↓ ↓
<b>0000MP8010A</b>	1	0,461	24,62	116x62x116
0000SE1222B	Red plastic bucket 20 L with plastic handle			1 pc.
0000SE1322A	TOP-DOWN® - blue plastic bucket 20 L with plastic handle and hermetic cover			1 pc.
0000SE1322B	TOP-DOWN® - red plastic bucket 20 L with plastic handle and hermetic cover			1 pc.
0000SM00115U	FLIP - handle holder with rubber roll and snap closure fitting tubes Ø 22 mm			1 pc.
0000SM00121U	FLIP - handle holder with rubber roll fitting plastic baskets art. P1191100U and Morgan trolleys			2 pc.
8211/1A	Blue plastic bucket 12 L with plastic handle			1 pc.
8211/1B	Red plastic bucket 12 L with plastic handle			1 pc.
P119001A	Blue small central plastic basket for Morgan trolley			2 pc.
P202002A	Short plastic base with wheels ø 125 mm and bumpers for Morgan trolley			1 pc.
P716010U	Plastic bag holder 1x40 L + 1x80 L with push-bar, bag-stretchers and reinforcements			1 pc.
R1030103	Rilsan 5-bar vertical frame for Morgan Top-Down			2 pc.
R2030120	Rilsan 10- and 20-litre Top-Down bucket trolley, with 170mm ø wheels			1 pc.
R2200120	Rilsan coated support for buckets 10 L and 20 L for Morgan trolleys art. 0000MP8010A and 0000MP8020A			1 pc.

#### ACCESSORIES TO ORDER AS SEPARATE ITEMS

0000AT0160A	Blue plastic-coated bag 57x98 cm, maximum capacity 80 L	1 pc.
0000AT0170B	Red plastic-coated bag 48x95 cm, maximum capacity 60 L	1 pc.
P291920UA	Blue plastic cover for bag holder 120 L with storage room, check-list holder and lock	1 pc.

REF.	PCK	VOLUME (m³)	GROSS WEIGHT (kg)	SIZE (cm) ↓ ↓ ↓
<b>0000MP8020A</b>	1	0,45	22,21	127x62x115
0000SE1222B	Red plastic bucket 20 L with plastic handle			1 pc.
0000SE1322A	TOP-DOWN® - blue plastic bucket 20 L with plastic handle and hermetic cover			1 pc.
0000SE1322B	TOP-DOWN® - red plastic bucket 20 L with plastic handle and hermetic cover			1 pc.
0000SM00115U	FLIP - handle holder with rubber roll and snap closure fitting tubes Ø 22 mm			1 pc.
0000SM00121U	FLIP - handle holder with rubber roll fitting plastic baskets art. P1191100U and Morgan trolleys			2 pc.
3048	Set of 3 stickers for buckets			1 pc.
8218A	Blue plastic bucket 6 L with plastic handle			1 pc.
8218B	Red plastic bucket 6 L with plastic handle			1 pc.
8218C	Yellow plastic bucket 6 L with plastic handle			1 pc.
8218F	Green plastic bucket 6 L with plastic handle			1 pc.
P119003A	Blue big central plastic basket with 6 hooks			2 pc.
P202053A	Long plastic base with 5 wheels ø 125 mm and bumpers for Morgan trolley			1 pc.
P716010U	Plastic bag holder 1x40 L + 1x80 L with push-bar, bag-stretchers and reinforcements			1 pc.
R1030103	Rilsan 5-bar vertical frame for Morgan Top-Down			2 pc.
R2030120	Rilsan 10- and 20-litre Top-Down bucket trolley, with 170mm ø wheels			1 pc.
R2200120	Rilsan coated support for buckets 10 L and 20 L for Morgan trolleys art. 0000MP8010A and 0000MP8020A			1 pc.

#### ACCESSORIES TO ORDER AS SEPARATE ITEMS

0000AT0160A	Blue plastic-coated bag 57x98 cm, maximum capacity 80 L	1 pc.
0000AT0170B	Red plastic-coated bag 48x95 cm, maximum capacity 60 L	1 pc.
P291920UA	Blue plastic cover for bag holder 120 L with storage room, check-list holder and lock	1 pc.

MULTIPURPOSE TROLLEYS



ALPHA

MORGAN

CHROMED AND RILSAN COATED TROLLEYS

## MORGAN TOP-DOWN® MIDI 7010 - plastic trolley



## MORGAN TOP-DOWN® MAXI 7020 - plastic trolley



REF.	PCK	VOLUME (m³)	GROSS WEIGHT (kg)	SIZE (cm) ↓ ↓ ↓
<b>0000MP7010A</b>	1	0,307	26,74	115x61x116
0000SE1222B	Red plastic bucket 20 L with plastic handle			1 pc.
0000SE1322A	TOP-DOWN® - blue plastic bucket 20 L with plastic handle and hermetic cover			1 pc.
0000SE1322B	TOP-DOWN® - red plastic bucket 20 L with plastic handle and hermetic cover			1 pc.
0000SM00115U	FLIP - handle holder with rubber roll and snap closure fitting tubes Ø 22 mm			1 pc.
0000SM00121U	FLIP - handle holder with rubber roll fitting plastic baskets art. P1191100U and Morgan trolleys			2 pc.
8211/1A	Blue plastic bucket 12 L with plastic handle			1 pc.
8211/1B	Red plastic bucket 12 L with plastic handle			1 pc.
P064000A	Blue plastic supporting plate for bucket 10 and 20 L fitting Morgan base			1 pc.
P119001A	Blue small central plastic basket for Morgan trolley			2 pc.
P202002A	Short plastic base with wheels ø 125 mm and bumpers for Morgan trolley			1 pc.
P716010U	Plastic bag holder 1x40 L + 1x80 L with push-bar, bag-stretchers and reinforcements			1 pc.
R1030103	Rilsan 5-bar vertical frame for Morgan Top-Down			2 pc.
R2200040	Rilsan coated bucket holder for buckets 10 and 20 L fitting Morgan vertical frame and Alpha trolley			1 pc.

### ACCESSORIES TO ORDER AS SEPARATE ITEMS

0000AT0160A	Blue plastic-coated bag 57x98 cm, maximum capacity 80 L	1 pc.
0000AT0170B	Red plastic-coated bag 48x95 cm, maximum capacity 60 L	1 pc.
P291920UA	Blue plastic cover for bag holder 120 L with storage room, check-list holder and lock	1 pc.

REF.	PCK	VOLUME (m³)	GROSS WEIGHT (kg)	SIZE (cm) ↓ ↓ ↓
<b>0000MP7020A</b>	1	0,251	30,28	127x61x115
0000SE1222B	Red plastic bucket 20 L with plastic handle			1 pc.
0000SE1322A	TOP-DOWN® - blue plastic bucket 20 L with plastic handle and hermetic cover			1 pc.
0000SE1322B	TOP-DOWN® - red plastic bucket 20 L with plastic handle and hermetic cover			1 pc.
0000SM00115U	FLIP - handle holder with rubber roll and snap closure fitting tubes Ø 22 mm			1 pc.
0000SM00121U	FLIP - handle holder with rubber roll fitting plastic baskets art. P1191100U and Morgan trolleys			2 pc.
3048	Set of 3 stickers for buckets			1 pc.
8218A	Blue plastic bucket 6 L with plastic handle			1 pc.
8218B	Red plastic bucket 6 L with plastic handle			1 pc.
8218C	Yellow plastic bucket 6 L with plastic handle			1 pc.
8218F	Green plastic bucket 6 L with plastic handle			1 pc.
P064000A	Blue plastic supporting plate for bucket 10 and 20 L fitting Morgan base			1 pc.
P119003A	Blue big central plastic basket with 6 hooks			2 pc.
P202053A	Long plastic base with 5 wheels ø 125 mm and bumpers for Morgan trolley			1 pc.
P716010U	Plastic bag holder 1x40 L + 1x80 L with push-bar, bag-stretchers and reinforcements			1 pc.
R1030103	Rilsan 5-bar vertical frame for Morgan Top-Down			2 pc.
R2200040	Rilsan coated bucket holder for buckets 10 and 20 L fitting Morgan vertical frame and Alpha trolley			1 pc.

### ACCESSORIES TO ORDER AS SEPARATE ITEMS

0000AT0160A	Blue plastic-coated bag 57x98 cm, maximum capacity 80 L	1 pc.
0000AT0170B	Red plastic-coated bag 48x95 cm, maximum capacity 60 L	1 pc.
P291920UA	Blue plastic cover for bag holder 120 L with storage room, check-list holder and lock	1 pc.



ALPHA

**MORGAN**

CHROMED AND RILSAN COATED TROLLEYS

## Components and accessories for Morgan trolleys

### Short plastic base for Morgan trolley



REF.	NOTES	SIZE (cm) ↓ ↓ ↓
P202001A	with wheels ø 100 mm	92x55
P202002A	with wheels ø 125 mm	92x55
P202017A	with rubber wheels ø 125 mm	92x55

### Long plastic base complete with 5 wheels for Morgan trolley



REF.	NOTES	SIZE (cm) ↓ ↓ ↓
P202050A	with wheels ø 100 mm	105x55
P202053A	with wheels ø 125 mm	105x55
P202067A	with rubber wheels ø 125 mm	105x55

### Plastic base complete with 5 wheels for Morgan Security trolley



REF.	NOTES	SIZE (cm) ↓ ↓ ↓
P402050U	with wheels ø 100 mm	105x55
P402053U	with wheels ø 125 mm	105x55
P402067U	with rubber wheels ø 125 mm	105x55

### Rilsan coated vertical frame complete with screws for Morgan trolley



REF.	NOTES
R1030010	

### Rilsan coated vertical frame with double connection for Morgan trolley art. 0000MP1030U



REF.	NOTES
R1030147	

### Rilsan coated vertical frame for Morgan trolley art. 0000MP4010A



REF.	NOTES
R1030137	



ALPHA

**MORGAN**

CHROMED AND RILSAN COATED TROLLEYS

Rilsan coated shaped vertical frame for Morgan trolley art. 0000MP1050A



REF.	NOTES
R1030125	

Rilsan coated vertical frame with 5 bars for Morgan Top-Down® trolley



REF.	NOTES
R1030103	

Rilsan coated vertical frame with 1 bar for Morgan Security trolley, 1 mt high



REF.	NOTES
R1030040	

Rilsan coated vertical frame with 3 bars for Morgan Security trolley, 1 mt high



REF.	NOTES
R1030134	where to fix the baskets art. P019004U

Small plastic basket for Morgan Security trolley



REF.	NOTES
P019004U	internal dimensions 44x26x11 cm

Set of 2 plastic slots for sliding drawers complete with fixing clips for Morgan Security trolley



REF.	NOTES
P2909934E	





ALPHA

**MORGAN**

CHROMED AND RILSAN COATED TROLLEYS

Small central plastic basket for Morgan trolley



REF.	NOTES	
P119001A	internal dimensions 44x26,5x11 cm	
P119001U	internal dimensions 44x26,5x11 cm	

Side plastic basket for Morgan trolley



REF.	NOTES	
P119002A	internal dimensions 49,5x18,5x11 cm	
P119002U	internal dimensions 49,5x18,5x11 cm	

Big central plastic basket with 6 hooks



REF.	NOTES	
P119003A	external dimension 48,5x37,5x11 cm	
P119003U	external dimension 48,5x37,5x11 cm	

Bag holder 120L without reinforcements, with push-bar, bag-stetchers, bag fixing hooks and 2 handle holders



REF.	NOTES
P906010U	

Plastic bag holder 120 L with push-bar, bag-stretchers and reinforcements



REF.	NOTES
P816010U	

Plastic bag holder 2x60 L with push-bar, bag-stretchers and reinforcements



REF.	NOTES
P516010U	

Plastic bag holder 1x40 L + 1x80 L with push-bar, bag-stretchers and reinforcements



REF.	NOTES
P716010U	



ALPHA

**MORGAN**

CHROMED AND RILSAN COATED TROLLEYS

Plastic bag stretcher for bag holder



REF.	NOTES
<b>P190920U</b>	for art. P816010U and P906010U
<b>P190921U</b>	for art. P516010U and P716010U

Divider for plastic bag holder 120 L



REF.	NOTES
<b>P206020U</b>	2x60 L
<b>P206030U</b>	1x40 L + 1x80 L
<b>P206040U</b>	3x40 L

Plastic divider with square shaped insert for bag holder 120 L



REF.	NOTES
<b>P306020U</b>	2x60 L and 20 L square shaped insert
<b>P406020U</b>	2x60 L and two 20 L square shaped inserts

For Alpha, Emotion range bag holders and bag holder code P906010U, Morgan range

Square plastic support 20 L for the divider of bag holder 120 L



REF.	NOTES
<b>P1909957U</b>	

For Alpha range bag holders and bag holder code P906010U, Morgan range - Use recommended with net bags, code 0000AT0210

Rilsan coated bag holder 120 L with bag-stretcher for Morgan trolley



REF.	NOTES
<b>R2060010</b>	

Rilsan coated bag holder 2x70 L for Morgan trolley



REF.	NOTES
<b>R3659</b>	

Rilsan coated bucket holder for bucket fitting vertical frame Morgan trolley



REF.	NOTES
<b>R1200020</b>	for bucket 28 L
<b>R2200040</b>	

# Multipurpose trolleys



ALPHA

**MORGAN**

CHROMED AND RILSAN COATED TROLLEYS

Rilsan coated bucket holder for buckets 10 and 20 L fitting vertical frame Morgan Security trolley



REF.	NOTES
<b>R2200041</b>	

Rilsan coated support for buckets 10 L and 20 L for Morgan trolleys art. 0000MP8010A and 0000MP8020A



REF.	NOTES
<b>R2200120</b>	



Rilsan coated wringer support complete with screws



REF.	NOTES
<b>R1040010</b>	

Supporting plastic plate fitting Morgan base





REF.	NOTES
<b>P074000A</b>	
<b>P074000U</b>	

Available on request with 1 wheel

Supporting plastic plate for bucket 10 and 20 L fitting Morgan base



REF.	NOTES	SIZE (cm)
<b>P064000A</b>		48x22x15 ↓ ↓ ↓
<b>P064000U</b>		48x22x15

Chromed side basket



REF.	NOTES
<b>3655</b>	

Fitting Morgan trolleys with 2 hooks art. 0000SM00113U



ALPHA

MORGAN

CHROMED AND RILSAN COATED TROLLEYS

Rilsan coated trolley for Top-Down® buckets 10 and 20 L, with wheels ø 170 mm



REF.	NOTES
R2030120	

Fitting Morgan trolleys art. 0000MP8010A and 0000MP8020A

**POCKET** - foldable metal trolley for Top-Down® buckets 10 and 20 L



REF.	NOTES
V2030122	

Plastic cabinet with locking key for Morgan trolley



REF.	NOTES	SIZE (cm) ↓ ↓ ↓
P1220203E		49x39x34

Plastic sliding drawer with locking key



REF.	NOTES	CAPACITY (L)	SIZE (cm) ↓ ↓ ↓
P2229909U	internal dimensions 41x34x9,5 cm	10	46,5x37,5x11
P2229906A	internal dimensions 40,5x34x16 cm	22	46,5x37,5x17
P2229906B	internal dimensions 40,5x34x16 cm	22	46,5x37,5x17
P2229906U	internal dimensions 40,5x34x16 cm	22	46,5x37,5x17
P2229907U	internal dimensions 40x34x33,5 cm	40	46,5x37,5x35

Shock absorbing piston for a soft closing of the cover



REF.	NOTES
P190908U	



Plastic cover for bag holder 120 L



REF.	NOTES
P291918A	
P291918B	



Please, require also no. 2 shock absorbing pistons art. P190908U for a perfect soft closing

# Multipurpose trolleys



ALPHA

MORGAN

CHROMED AND RILSAN COATED TROLLEYS

Plastic cover for bag holder 120 L with check-list holder

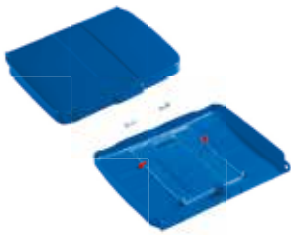

REF.	NOTES
P291919A	
P291919B	
P291919T	



Please, require also no. 2 shock absorbing pistons art. P190908U for a perfect soft closing

Plastic cover for bag holder 120 L with storage room, check-list holder and lock

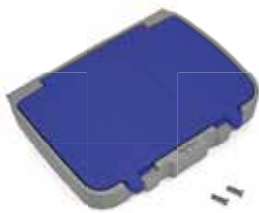

REF.	NOTES
P291920UA	
P291920UB	
P291920U	



Please, require also no. 2 shock absorbing pistons art. P190908U for a perfect soft closing

Plastic cover for bag holder 120 L art. 3657-R2060010- I2060010 and R2060060



REF.	NOTES
3639A	
3639B	

Plastic cover for bag holder 2x70L ref. 3637, 3659, I2060020 and R206005



REF.	NOTES
3644A	
3644B	

Plastic basin 35 L



REF.	NOTES
3641A	

Pierced plastic sieve for basin 35 L



REF.	NOTES
3642	

MULTIPURPOSE TROLLEYS



ALPHA

**MORGAN**

CHROMED AND RILSAN COATED TROLLEYS

Rilsan coated broom/mop head holder support complete with fixing set



REF.	NOTES
R2050010	

Plastic broom/mop holder support for Morgan trolleys



REF.	NOTES
P119008U	

**PEG KIT** - kit for attaching OneFred on Morgan trolleys complete with mop holder

**NEW**



REF.	NOTES
0000SM00297	



**PEG KIT** - kit for attaching OneFred on Morgan trolleys

**NEW**



REF.	NOTES
0000SM00300	



MULTIPURPOSE  
TROLLEYS

# Multipurpose trolleys



ALPHA

MORGAN

CHROMED AND RILSAN COATED TROLLEYS

## Teddy trolleys

### TEDDY 8080 - chromed trolley



REF.	PCK	VOLUME (m <sup>3</sup> )	GROSS WEIGHT (kg)	SIZE (cm) ↓ ↓ ↓
<b>8080X</b>	1	0,191	12,48	82x51x105

0000SM00115U	FLIP - handle holder with rubber roll and snap closure fitting tubes Ø22 mm	1 pc.
3657	Chromed bag holder 120 L for Teddy trolleys	1 pc.
8203/2	Chromed vertical frame for Teddy trolleys	1 pc.
8205/2	Chromed basket for Teddy and art. 8076 trolleys	1 pc.
8211/1A	Blue plastic bucket 12 L with plastic handle	1 pc.
8211/1B	Red plastic bucket 12 L with plastic handle	1 pc.
8234	Chromed bucket holder for Teddy trolleys	1 pc.
8611U	Plastic flanges with screws for vertical frame fixing	2 pc.
C8201CL	Chromed base 47x80 cm with wheels ø 100 mm and bumpers for trolleys art. 8080X and 8083X	1 pc.

#### ACCESSORIES TO ORDER AS SEPARATE ITEMS

3639B	Red plastic cover for bag holder 120 L art. 3657-R2060010-I2060010 and R2060060	1 pc.
3650B	Red plastified bag 73x97,5 cm, capacity 120 L	1 pc.
8227	Plastic tray for the base of the trolleys art. 8049, Teddy 8090X-8098X and Panda	1 pc.

### TEDDY 8089 - chromed trolley



REF.	PCK	VOLUME (m <sup>3</sup> )	GROSS WEIGHT (kg)	SIZE (cm) ↓ ↓ ↓
<b>8089X</b>	1	0,191	16,57	82x51x105

0000SM00115U	FLIP - handle holder with rubber roll and snap closure fitting tubes Ø22 mm	1 pc.
3657	Chromed bag holder 120 L for Teddy trolleys	1 pc.
7004A	REGULAR - blue plastic down-press wringer with plastic gears	1 pc.
8203/2	Chromed vertical frame for Teddy trolleys	1 pc.
8205/2	Chromed basket for Teddy and art. 8076 trolleys	1 pc.
8211/1A	Blue plastic bucket 12 L with plastic handle	1 pc.
8211/1B	Red plastic bucket 12 L with plastic handle	1 pc.
8611U	Plastic flanges with screws for vertical frame fixing	4 pcs
C30075CL	Chromed base 47x80 cm with wheels ø 100 mm and bumpers for trolleys art. 8089X	1 pc.
C30277	Wringer support per Teddy cod. 8089X	1 pc.

#### ACCESSORIES TO ORDER AS SEPARATE ITEMS

3639B	Red plastic cover for bag holder 120 L art. 3657-R2060010-I2060010 and R2060060	1 pc.
3650B	Red plastified bag 73x97,5 cm, capacity 120 L	1 pc.

### TEDDY R8089 - Rilsan coated trolley

REF.	PCK	VOLUME (m <sup>3</sup> )	GROSS WEIGHT (kg)	SIZE (cm) ↓ ↓ ↓
<b>R8089</b>	1	0,191	16,57	82x51x105

Available while stocks last



ALPHA

MORGAN

CHROMED AND RILSAN COATED TROLLEYS

## TEDDY 8090 - chromed trolley



## TEDDY 8098 - chromed trolley



REF.	PCK	VOLUME (m³)	GROSS WEIGHT (kg)	SIZE (cm) ↓ ↓ ↓
<b>8090X</b>	1	0,251	17,73	100x66x105

REF.	PCK	VOLUME (m³)	GROSS WEIGHT (kg)	SIZE (cm) ↓ ↓ ↓
<b>8098X</b>	1	0,251	30,23	134x66x110

0000SM00115U	FLIP - handle holder with rubber roll and snap closure fitting tubes Ø22 mm	1 pc.
30141	Chromed wringer support for trolley art. 8098X	1 pc.
30300CL	Chromed base 47x100 cm with wheels ø 100 mm and bumpers for trolleys art. 8090X and 8098X	1 pc.
3657	Chromed bag holder 120 L for Teddy trolleys	1 pc.
60233U	Plastic anti-spill tray for bases art. C8201CL, 30300CL and C30139CL	1 pc.
7004A	REGULAR - blue plastic down-press wringer with plastic gears	1 pc.
8108A	Blue plastic bucket 15 L with plastic handle	1 pc.
8108B	Red plastic bucket 15 L with plastic handle	1 pc.
8203/2	Chromed vertical frame for Teddy trolleys	1 pc.
8205/2	Chromed basket for Teddy and art. 8076 trolleys	1 pc.
8611U	Plastic flanges with screws for vertical frame fixing	4 pcs

0000SM00115U	FLIP - handle holder with rubber roll and snap closure fitting tubes Ø22 mm	1 pc.
30141	Chromed wringer support for trolley art. 8098X	1 pc.
30300CL	Chromed base 47x100 cm with wheels ø 100 mm and bumpers for trolleys art. 8090X and 8098X	1 pc.
30302	Central basket holder for trolley art. 9098X	2 pc.
30303	Bag support for Teddy art. 8098X	1 pc.
3048	Set of 3 stickers for buckets	1 pc.
3657	Chromed bag holder 120 L for Teddy trolleys	1 pc.
3671	Rod with nuts for Teddy trolleys	2 pc.
60233U	Plastic anti-spill tray for bases art. C8201CL, 30300CL and C30139CL	1 pc.
7004A	REGULAR - blue plastic down-press wringer with plastic gears	1 pc.
8108A	Blue plastic bucket 15 L with plastic handle	1 pc.
8108B	Red plastic bucket 15 L with plastic handle	1 pc.
8203/2	Chromed vertical frame for Teddy trolleys	2 pc.
8218A	Blue plastic bucket 6 L with plastic handle	1 pc.
8218B	Red plastic bucket 6 L with plastic handle	1 pc.
8218C	Yellow plastic bucket 6 L with plastic handle	1 pc.
8218F	Green plastic bucket 6 L with plastic handle	1 pc.
8227	Plastic tray for the base of the trolleys art. 8049, Teddy 8090X-8098X and Panda	1 pc.
8253	Central plastic basket for Teddy and Jumbo Quadri trolleys	2 pc.
8611U	Plastic flanges with screws for vertical frame fixing	6 pcs

### ACCESSORIES TO ORDER AS SEPARATE ITEMS

3639B	Red plastic cover for bag holder 120 L art. 3657-R2060010-I2060010 and R2060060	1 pc.
3650B	Red plastified bag 73x97,5 cm, capacity 120 L	1 pc.
8227	Plastic tray for the base of the trolleys art. 8049, Teddy 8090X-8098X and Panda	1 pc.

### ACCESSORIES TO ORDER AS SEPARATE ITEMS

3639B	Red plastic cover for bag holder 120 L art. 3657-R2060010-I2060010 and R2060060	1 pc.
3650B	Red plastified bag 73x97,5 cm, capacity 120 L	1 pc.
60232	Transparent plastic cover for bucket 6 L	1 pc.

## TEDDY R8090 - Rilsan coated trolley

REF.	PCK	VOLUME (m³)	GROSS WEIGHT (kg)	SIZE (cm) ↓ ↓ ↓
<b>R8090</b>	1	0,251	17,73	100x66x105

## TEDDY R8098 - Rilsan coated trolley

REF.	PCK	VOLUME (m³)	GROSS WEIGHT (kg)	SIZE (cm) ↓ ↓ ↓
<b>R8098</b>	1	0,251	30,23	134x66x110

Available while stocks last

Available while stocks last



# Multipurpose trolleys



ALPHA

MORGAN

CHROMED AND RILSAN COATED TROLLEYS

## TEDDY 8200 - chromed trolley



## TEDDY R8200 - Rilsan coated trolley



REF.	PCK	VOLUME (m³)	GROSS WEIGHT (kg)	SIZE (cm) ↓ ↓ ↓
<b>8200X</b>	1	0,359	22,27	82x72x105

REF.	PCK	VOLUME (m³)	GROSS WEIGHT (kg)	SIZE (cm) ↓ ↓ ↓
<b>R8200</b>	1	0,359	25,77	82x72x105

0000SM00115U	FLIP - handle holder with rubber roll and snap closure fitting tubes Ø 22 mm	1 pc.
3640	Side plastic basket	1 pc.
3657	Chromed bag holder 120 L for Teddy trolleys	1 pc.
7004A	REGULAR - blue plastic down-press wringer with plastic gears	1 pc.
8107A	Blue plastic bucket 25 L with plastic handle	1 pc.
8107B	Red plastic bucket 25 L with plastic handle	1 pc.
8211/1A	Blue plastic bucket 12 L with plastic handle	1 pc.
8211/1B	Red plastic bucket 12 L with plastic handle	1 pc.
8234	Chromed bucket holder for Teddy trolleys	1 pc.
8267	Basket holder for basket art. 3640	1 pc.
8611U	Plastic flanges with screws for vertical frame fixing	3 pcs
C30139CL	Chromed base 64x79 cm with wheels ø 100 mm and bumpers for trolley art. 8200X	1 pc.
C30140/2	Chromed vertical frame for trolley art. 8200X	1 pc.

0000SM00115U	FLIP - handle holder with rubber roll and snap closure fitting tubes Ø 22 mm	1 pc.
3640	Side plastic basket	1 pc.
7004A	REGULAR - blue plastic down-press wringer with plastic gears	1 pc.
8107A	Blue plastic bucket 25 L with plastic handle	1 pc.
8107B	Red plastic bucket 25 L with plastic handle	1 pc.
8211/1A	Blue plastic bucket 12 L with plastic handle	1 pc.
8211/1B	Red plastic bucket 12 L with plastic handle	1 pc.
8611U	Plastic flanges with screws for vertical frame fixing	3 pcs
R30139CL	Rilsan coated base 64x79 cm with wheels ø 100 mm and bumpers	1 pc.
R30140	Rilsan coated vertical frame for trolley art. 8200X	1 pc.
R3657	Rilsan coated bag holder 120 L for Teddy trolleys	1 pc.
R8234	Rilsan coated bucket holder for Teddy trolleys	1 pc.
R8267	Rilsan coated basket holder for basket art. 3640	1 pc.

### ACCESSORIES TO ORDER AS SEPARATE ITEMS

3639B	Red plastic cover for bag holder 120 L art. 3657-R2060010-I2060010 and R2060060	1 pc.
3650B	Red plastified bag 73x97,5 cm, capacity 120 L	1 pc.
8227	Plastic tray for the base of the trolleys art. 8049, Teddy 8090X-8098X and Panda	1 pc.

### ACCESSORIES TO ORDER AS SEPARATE ITEMS

3639B	Red plastic cover for bag holder 120 L art. 3657-R2060010-I2060010 and R2060060	1 pc.
3650B	Red plastified bag 73x97,5 cm, capacity 120 L	1 pc.
8227	Plastic tray for the base of the trolleys art. 8049, Teddy 8090X-8098X and Panda	1 pc.

Available while stocks last



ALPHA

MORGAN

CHROMED AND RILSAN COATED TROLLEYS

## Components and accessories for Teddy trolleys

### Chromed base with wheels ø 100 mm and bumpers for Teddy trolleys



REF.	NOTES
<b>30300CL</b>	for art. 8090X e 8098X
<b>C30075CL</b>	for art. 8089X
<b>C30139CL</b>	for art. 8200X
<b>C8201CL</b>	for art. 8080X and 8083X

### Chromed vertical frame



REF.	NOTES
<b>8203/2</b>	

### Chromed vertical frame for trolley art. 8200X



REF.	NOTES
<b>C30140/2</b>	

### Chromed wringer support for trolley art. 8098X



REF.	NOTES
<b>30141</b>	

### Chromed basket for Teddy and art. 8076 trolleys



REF.	NOTES	SIZE (cm) ↓ ↓ ↓
<b>8205/2</b>		50x20x13

### Chromed bucket holder



REF.	NOTES
<b>8234</b>	

### Basket holder for basket art. 3640



REF.	NOTES
<b>8267</b>	

# Multipurpose trolleys



ALPHA

MORGAN

CHROMED AND RILSAN COATED TROLLEYS

## Side plastic basket



REF.	NOTES
3640	internal dimension 40x23x11 cm

## Central basket holder for trolley art. 9098X



REF.	NOTES
30302	

## Rod with nuts for Teddy trolleys



REF.	NOTES
3671	

## Central plastic basket



REF.	NOTES
8252	for Jumbo Tank and Master - internal dimensions 63x45x7x cm
8253	for Teddy and Jumbo Quadri - internal dimensions 44x45x7 cm
3638	for Jumbo Quick and Mini Jumbo - internal dimensions 43,5x27,5x11 cm

## Chromed bag holder 120 L for Teddy trolleys



REF.	NOTES
3657	

## Chromed bag holder 2x70 L for Teddy trolleys



REF.	NOTES
3659	

## Plastic tray for the base of the trolleys art. 8049, Teddy 8090X-8098X and Panda



REF.	NOTES	SIZE (cm) ↓↓↓
8227		39,5x59x2,5



ALPHA

MORGAN

CHROMED AND RILSAN COATED TROLLEYS



Plastic anti-spill tray for bases art. C8201CL, 30300CL and C30139CL



REF.	NOTES
60233U	

Plastic cover for bag holder 120 L art. 3657-R2060010- I2060010 and R2060060



REF.	NOTES
3639A	
3639B	

Plastic cover for bag holder 2x70L ref. 3637, 3659, I2060020 and R206005



REF.	NOTES
3644A	
3644B	

Chromed broom/mop holder



REF.	NOTES
8213	

Fixing clips for broom/mop holder support (2 pcs)



REF.	NOTES
8225U	

Plastic bag fixing clip



REF.	NOTES
8220A	

Plastic flanges with screws for vertical frame fixing



REF.	NOTES
8611U	



ALPHA

MORGAN

CHROMED AND RILSAN COATED TROLLEYS

## Jumbo trolleys

### JUMBO TANK 3050 - chromed trolley



REF.	PCK	VOLUME (m³)	GROSS WEIGHT (kg)	SIZE (cm) ↓ ↓ ↓
<b>3050</b>	1	0,447	43,18	150x58x110

30006	Chromed fixing kit for basin art. 3641A	2 pc.
3048	Set of 3 stickers for buckets	1 pc.
3058	Mop trolley 30 L complete for Jumbo	1 pc.
3604	Chromed vertical frame for Jumbo trolley	2 pc.
3611	Tray holder for art. 8252 with handle holder for Jumbo Tank trolley	1 pc.
3615	Chromed holder for plastic basket art. 8252 for Jumbo Master trolley	1 pc.
3633	Chromed bag support for Jumbo trolley	1 pc.
3637	Chromed bag holder 2x70 L for Jumbo trolleys and Panda art. 7221	1 pc.
3641A	Plastic basin 35 L	1 pc.
3642	Pierced plastic sieve for basin 35 L	1 pc.
3665	Chromed bucket holder for tray art. 8252	1 pc.
8218A	Blue plastic bucket 6 L with plastic handle	1 pc.
8218B	Red plastic bucket 6 L with plastic handle	1 pc.
8218C	Yellow plastic bucket 6 L with plastic handle	1 pc.
8218F	Green plastic bucket 6 L with plastic handle	1 pc.
8252	Central plastic basket for Jumbo Tank and Master trolleys	2 pc.
C3629CL	Chromed base 77x51 cm with wheels ø 100 mm and bumpers for Jumbo Tank, Master and Quick trolleys	1 pc.

#### ACCESSORIES TO ORDER AS SEPARATE ITEMS

0000AT0160A	Blue plastic-coated bag 57x98 cm, maximum capacity 80 L	1 pc.
0000AT0160B	Red plastified bag 57x98 cm, capacity 80 L	1 pc.
3644A	Plastic cover for bag holder 2x70L ref. 3637, 3659, I2060020 and R206005, blue	1 pc.
3644B	Plastic cover for bag holder 2x70L ref. 3637, 3659, I2060020 and R206005, red	1 pc.
60232	Transparent plastic cover for bucket 6 L	1 pc.

### JUMBO TANK 3054 - chromed trolley



REF.	PCK	VOLUME (m³)	GROSS WEIGHT (kg)	SIZE (cm) ↓ ↓ ↓
<b>3054</b>	1	0,291	34,62	142x58x110

0000SM00115U	FLIP - handle holder with rubber roll and snap closure fitting tubes Ø 22 mm	1 pc.
30006	Chromed fixing kit for basin art. 3641A	2 pc.
3048	Set of 3 stickers for buckets	1 pc.
3604	Chromed vertical frame for Jumbo trolley	2 pc.
3611	Tray holder for art. 8252 with handle holder for Jumbo Tank trolley	1 pc.
3615	Chromed holder for plastic basket art. 8252 for Jumbo Master trolley	1 pc.
3633	Chromed bag support for Jumbo trolley	1 pc.
3637	Chromed bag holder 2x70 L for Jumbo trolleys and Panda art. 7221	1 pc.
3641A	Plastic basin 35 L	1 pc.
3642	Pierced plastic sieve for basin 35 L	1 pc.
3665	Chromed bucket holder for tray art. 8252	1 pc.
8218A	Blue plastic bucket 6 L with plastic handle	1 pc.
8218B	Red plastic bucket 6 L with plastic handle	1 pc.
8218C	Yellow plastic bucket 6 L with plastic handle	1 pc.
8218F	Green plastic bucket 6 L with plastic handle	1 pc.
8252	Central plastic basket for Jumbo Tank and Master trolleys	2 pc.
C3629CL	Chromed base 77x51 cm with wheels ø 100 mm and bumpers for Jumbo Tank, Master and Quick trolleys	1 pc.

#### ACCESSORIES TO ORDER AS SEPARATE ITEMS

0000AT0160A	Blue plastic-coated bag 57x98 cm, maximum capacity 80 L	1 pc.
0000AT0160B	Red plastified bag 57x98 cm, capacity 80 L	1 pc.
3644A	Plastic cover for bag holder 2x70L ref. 3637, 3659, I2060020 and R206005, blue	1 pc.
3644B	Plastic cover for bag holder 2x70L ref. 3637, 3659, I2060020 and R206005, red	1 pc.
60232	Transparent plastic cover for bucket 6 L	1 pc.



ALPHA

MORGAN

CHROMED AND RILSAN COATED TROLLEYS

## JUMBO MASTER 3061 - chromed trolley



## JUMBO MASTER 3064 - chromed trolley



REF.	PCK	VOLUME (m³)	GROSS WEIGHT (kg)	SIZE (cm) ↓ ↓ ↓
<b>3061</b>	1	0,373	33,22	113x67x110

REF.	PCK	VOLUME (m³)	GROSS WEIGHT (kg)	SIZE (cm) ↓ ↓ ↓
<b>3064</b>	1	0,291	31,71	113x67x110

0000SM00115U	FLIP - handle holder with rubber roll and snap closure fitting tubes Ø 22 mm	1 pc.
3604	Chromed vertical frame for Jumbo trolley	2 pc.
3613	Chromed basket for Jumbo Master trolley	2 pc.
3614	Chromed rod for basket art. 3613 for Jumbo Master trolley	1 pc.
3628	Chromed wringer support for Jumbo Master trolley	1 pc.
3633	Chromed bag support for Jumbo trolley	1 pc.
3637	Chromed bag holder 2x70 L for Jumbo trolleys and Panda art. 7221	1 pc.
3667A	PICK-UP - blue plastic bin 45 L without wheels, complete with cover and screen printed plastic plate with image 'paper'	1 pc.
3667B	PICK-UP - red plastic bin 45 L without wheels, complete with cover and screen printed plastic plate with image 'metal'	1 pc.
7004A	REGULAR - blue plastic down-press wringer with plastic gears	1 pc.
8108A	Blue plastic bucket 15 L with plastic handle	1 pc.
8108B	Red plastic bucket 15 L with plastic handle	1 pc.
8218A	Blue plastic bucket 6 L with plastic handle	1 pc.
8218B	Red plastic bucket 6 L with plastic handle	1 pc.
8218C	Yellow plastic bucket 6 L with plastic handle	1 pc.
8227	Plastic tray for the base of the trolleys art. 8049, Teddy 8090X-8098X and Panda	1 pc.
C3629CL	Chromed base 77x51 cm with wheels ø 100 mm and bumpers for Jumbo Tank, Master and Quick trolleys	1 pc.
C3662	Holder for buckets 15 L for trolley art. 3061	1 pc.

0000SM00115U	FLIP - handle holder with rubber roll and snap closure fitting tubes Ø 22 mm	1 pc.
3604	Chromed vertical frame for Jumbo trolley	2 pc.
3606	Chromed bag holder 120 L for Jumbo trolley	1 pc.
3613	Chromed basket for Jumbo Master trolley	2 pc.
3613/1	Chromed basket with long hooking system for Jumbo Master trolleys	1 pc.
3614	Chromed rod for basket art. 3613 for Jumbo Master trolley	3 pcs
3626	Chromed holder for plastic basket fitting the base of the Jumbo trolley art. 3064	1 pc.
3628	Chromed wringer support for Jumbo Master trolley	1 pc.
3633	Chromed bag support for Jumbo trolley	1 pc.
7004A	REGULAR - blue plastic down-press wringer with plastic gears	1 pc.
8108A	Blue plastic bucket 15 L with plastic handle	1 pc.
8108B	Red plastic bucket 15 L with plastic handle	1 pc.
8211/1A	Blue plastic bucket 12 L with plastic handle	1 pc.
8211/1B	Red plastic bucket 12 L with plastic handle	1 pc.
8252	Central plastic basket for Jumbo Tank and Master trolleys	1 pc.
C3629CL	Chromed base 77x51 cm with wheels ø 100 mm and bumpers for Jumbo Tank, Master and Quick trolleys	1 pc.

### ACCESSORIES TO ORDER AS SEPARATE ITEMS

0000AT0160A	Blue plastic-coated bag 57x98 cm, maximum capacity 80 L	1 pc.
0000AT0160B	Red plastified bag 57x98 cm, capacity 80 L	1 pc.
3644A	Plastic cover for bag holder 2x70L ref. 3637, 3659, I2060020 and R206005, blue	1 pc.
3644B	Plastic cover for bag holder 2x70L ref. 3637, 3659, I2060020 and R206005, red	1 pc.
60232	Transparent plastic cover for bucket 6 L	1 pc.

### ACCESSORIES TO ORDER AS SEPARATE ITEMS

3639B	Red plastic cover for bag holder 120 L art. 3657-R2060010-I2060010 and R2060060	1 pc.
3650B	Red plastified bag 73x97,5 cm, capacity 120 L	1 pc.

### JUMBO MASTER R3064 - Rilsan coated trolley

REF.	PCK	VOLUME (m³)	GROSS WEIGHT (kg)	SIZE (cm) ↓ ↓ ↓
<b>R3064</b>	1	0,291	32,71	113x67x110

Available while stocks last

## JUMBO MASTER R3061 - Rilsan coated trolley

REF.	PCK	VOLUME (m³)	GROSS WEIGHT (kg)	SIZE (cm) ↓ ↓ ↓
<b>R3061</b>	1	0,367	29,59	113x67x110

Available while stocks last

# Multipurpose trolleys



ALPHA

MORGAN

CHROMED AND RILSAN COATED TROLLEYS

## JUMBO MASTER 3072 - chromed trolley



## JUMBO QUADRI 3080 - chromed trolley



REF.	PCK	VOLUME (m³)	GROSS WEIGHT (kg)	SIZE (cm) ↓ ↓ ↓
<b>3072</b>	1	0,291	20,62	84x58x110

REF.	PCK	VOLUME (m³)	GROSS WEIGHT (kg)	SIZE (cm) ↓ ↓ ↓
<b>3080</b>	1	0,291	22,62	122x58x110

0000SM00115U	FLIP - handle holder with rubber roll and snap closure fitting tubes Ø 22 mm	1 pc.
3604	Chromed vertical frame for Jumbo trolley	2 pc.
3615	Chromed holder for plastic basket art. 8252 for Jumbo Master trolley	2 pc.
8252	Central plastic basket for Jumbo Tank and Master trolleys	3 pcs
C3629CL	Chromed base 77x51 cm with wheels ø 100 mm and bumpers for Jumbo Tank, Master and Quick trolleys	1 pc.

3604	Chromed vertical frame for Jumbo trolley	2 pc.
3606	Chromed bag holder 120 L for Jumbo trolley	1 pc.
3607	Chromed basket holder for Jumbo Quadri trolley	2 pc.
3633	Chromed bag support for Jumbo trolley	1 pc.
3640	Side plastic basket	1 pc.
7166	Holder for plastic basket art. 3640	1 pc.
8218A	Blue plastic bucket 6 L with plastic handle	1 pc.
8218B	Red plastic bucket 6 L with plastic handle	1 pc.
8253	Central plastic basket for Teddy and Jumbo Quadri trolleys	3 pcs
C3605CL	Chromed base 51x51 cm with wheels ø 100 mm and bumpers for Jumbo Quadri trolley	1 pc.

### ACCESSORIES TO ORDER AS SEPARATE ITEMS

3639B	Red plastic cover for bag holder 120 L art. 3657-R2060010-I2060010 and R2060060	1 pc.
3650B	Red plastified bag 73x97,5 cm, capacity 120 L	1 pc.
60232	Transparent plastic cover for bucket 6 L	2 pc.



ALPHA

MORGAN

CHROMED AND RILSAN COATED TROLLEYS

## JUMBO QUADRI 3082 - chromed trolley



## JUMBO QUICK 3090 - chromed trolley



REF.	PCK	VOLUME (m³)	GROSS WEIGHT (kg)	SIZE (cm) ↓ ↓ ↓
<b>3082</b>	1	0,291	17,62	136x58x110

3604	Chromed vertical frame for Jumbo trolley	2 pc.
3606	Chromed bag holder 120 L for Jumbo trolley	2 pc.
3607	Chromed basket holder for Jumbo Quadri trolley	2 pc.
3633	Chromed bag support for Jumbo trolley	1 pc.
8253	Central plastic basket for Teddy and Jumbo Quadri trolleys	3 pcs
C3605CL	Chromed base 51x51 cm with wheels ø 100 mm and bumpers for Jumbo Quadri trolley	1 pc.

### ACCESSORIES TO ORDER AS SEPARATE ITEMS

3639A	Blue plastic cover for bag holder 120 L art. 3657-R2060010-I2060010 and R2060060	1 pc.
3639B	Red plastic cover for bag holder 120 L art. 3657-R2060010-I2060010 and R2060060	1 pc.
3650A	Blue plastified bag 73x97,5 cm, capacity 120 L	1 pc.
3650B	Red plastified bag 73x97,5 cm, capacity 120 L	1 pc.

Available while stocks last

REF.	PCK	VOLUME (m³)	GROSS WEIGHT (kg)	SIZE (cm) ↓ ↓ ↓
<b>3090</b>	1	0,291	19,36	105x58x110

3600	Chromed wringer support for Jumbo trolley	1 pc.
3604	Chromed vertical frame for Jumbo trolley	2 pc.
3606	Chromed bag holder 120 L for Jumbo trolley	1 pc.
3624	Chromed holder for plastic basket art. 3638 for Jumbo Quick trolley	2 pc.
3633	Chromed bag support for Jumbo trolley	1 pc.
3638	Central plastic basket for Jumbo Quick and Mini Jumbo trolleys	3 pcs
60234	Plastic anti-spill tray for Jumbo trolley	1 pc.
7004A	REGULAR - blue plastic down-press wringer with plastic gears	1 pc.
8108A	Blue plastic bucket 15 L with plastic handle	1 pc.
8108B	Red plastic bucket 15 L with plastic handle	1 pc.
C3629CL	Chromed base 77x51 cm with wheels ø 100 mm and bumpers for Jumbo Tank, Master and Quick trolleys	1 pc.

### ACCESSORIES TO ORDER AS SEPARATE ITEMS

3639B	Red plastic cover for bag holder 120 L art. 3657-R2060010-I2060010 and R2060060	1 pc.
3650B	Red plastified bag 73x97,5 cm, capacity 120 L	1 pc.

## JUMBO QUICK R3090 - Rilsan coated trolley

REF.	PCK	VOLUME (m³)	GROSS WEIGHT (kg)	SIZE (cm) ↓ ↓ ↓
<b>R3090</b>	1	0,291	31,71	105x58x110

Available while stocks last





ALPHA

MORGAN

CHROMED AND RILSAN COATED TROLLEYS

## MINI JUMBO 3010 - chromed trolley



REF.	PCK	VOLUME (m³)	GROSS WEIGHT (kg)	SIZE (cm) ↓ ↓ ↓
<b>3010</b>	1	0,291	16,62	64x57x110

0000SM00115U	FLIP - handle holder with rubber roll and snap closure fitting tubes Ø 22 mm	1 pc.
13633	Bag support with wheel Ø 80 mm for Jumbo trolley	1 pc.
3604	Chromed vertical frame for Jumbo trolley	2 pc.
3606	Chromed bag holder 120 L for Jumbo trolley	1 pc.
3624	Chromed holder for plastic basket art. 3638 for Jumbo Quick trolley	2 pc.
3638	Central plastic basket for Jumbo Quick and Mini Jumbo trolleys	3 pcs
3663CL	Chromed base 39x50 cm with wheels ø 100 mm and bumpers for Mini Jumbo trolleys	1 pc.

### ACCESSORIES TO ORDER AS SEPARATE ITEMS

3639B	Red plastic cover for bag holder 120 L art. 3657-R2060010-12060010 and R2060060	1 pc.
3650B	Red plastified bag 73x97,5 cm, capacity 120 L	1 pc.

## MINI JUMBO R3010 - Rilsan coated trolley

REF.	PCK	VOLUME (m³)	GROSS WEIGHT (kg)	SIZE (cm) ↓ ↓ ↓
<b>R3010</b>	1	0,291	16,62	64x57x110

Available while stocks last



ALPHA

MORGAN

CHROMED AND RILSAN COATED TROLLEYS

## Smart trolleys

### SMART 7230 - chromed trolley



REF.	PCK	VOLUME (m <sup>3</sup> )	GROSS WEIGHT (kg)	SIZE (cm) ↓ ↓ ↓
<b>7230</b>	1	0,244	20,02	85x66x115
0000SM00115U	FLIP - handle holder with rubber roll and snap closure fitting tubes Ø 22 mm			1 pc.
30601	Vertical frame for Smart trolleys			1 pc.
30606	Chromed bag holder 120 L for Smart trolleys			1 pc.
60233U	Plastic anti-spill tray for bases art. C8201CL, 30300CL and C30139CL			1 pc.
7004A	REGULAR - blue plastic down-press wringer with plastic gears			1 pc.
8108A	Blue plastic bucket 15 L with plastic handle			1 pc.
8108B	Red plastic bucket 15 L with plastic handle			1 pc.
8218A	Blue plastic bucket 6 L with plastic handle			1 pc.
8218B	Red plastic bucket 6 L with plastic handle			1 pc.
8611U	Plastic flanges with screws for vertical frame fixing			1 pc.
C30600CL	Chromed base with wheels ø 100 mm and bumpers for Smart trolleys			1 pc.
C30602CL	Chromed wringer support for Smart trolleys			1 pc.
C30605	Chromed bag support for Smart trolleys			1 pc.
C30610	Chromed basket for Smart trolley art. 7230			1 pc.

#### ACCESSORIES TO ORDER AS SEPARATE ITEMS

3650B	Red plastified bag 73x97,5 cm, capacity 120 L			1 pc.
60232	Transparent plastic cover for bucket 6 L			2 pc.

### SMART R7230 - Rilsan coated trolley

REF.	PCK	VOLUME (m <sup>3</sup> )	GROSS WEIGHT (kg)	SIZE (cm) ↓ ↓ ↓
<b>R7230</b>	1	0,244	22,02	66x85x115

Available while stocks last

### SMART 7235 - chromed trolley



REF.	PCK	VOLUME (m <sup>3</sup> )	GROSS WEIGHT (kg)	SIZE (cm) ↓ ↓ ↓
<b>7235</b>	1	0,244	12,48	85x53x105
0000SM00115U	FLIP - handle holder with rubber roll and snap closure fitting tubes Ø 22 mm			1 pc.
30601	Vertical frame for Smart trolleys			1 pc.
3640	Side plastic basket			1 pc.
3657	Chromed bag holder 120 L for Teddy trolleys			1 pc.
8218A	Blue plastic bucket 6 L with plastic handle			1 pc.
8218B	Red plastic bucket 6 L with plastic handle			1 pc.
8227	Plastic tray for the base of the trolleys art. 8049, Teddy 8090X-8098X and Panda			1 pc.
C30600CL	Chromed base with wheels ø 100 mm and bumpers for Smart trolleys			1 pc.
C30604	Chromed basket for Smart trolley art. 7235			2 pc.

#### ACCESSORIES TO ORDER AS SEPARATE ITEMS

3639B	Red plastic cover for bag holder 120 L art. 3657-R2060010-I2060010 and R2060060			1 pc.
3650B	Red plastified bag 73x97,5 cm, capacity 120 L			1 pc.
60232	Transparent plastic cover for bucket 6 L			2 pc.

### SMART R7235 - Rilsan coated trolley

REF.	PCK	VOLUME (m <sup>3</sup> )	GROSS WEIGHT (kg)	SIZE (cm) ↓ ↓ ↓
<b>R7235</b>	1	0,244	14,93	53x85x105

Available while stocks last



ALPHA

MORGAN

CHROMED AND RILSAN COATED TROLLEYS

## Components and accessories for Jumbo and Ecology trolleys

### Chromed base with wheels ø 100 mm and bumpers for Jumbo trolley



REF.	NOTES	SIZE (cm) ↓ ↓ ↓
<b>C3629CL</b>	for Jumbo Tank, Master and Quick	77x51
<b>C3605CL</b>	for Jumbo Quadri	51x51
<b>3663CL</b>	for Mini Jumbo	39x50

### Chromed vertical frame for Jumbo trolley



REF.	NOTES
<b>3604</b>	

### Chromed bag support for Jumbo trolley



REF.	NOTES
<b>3633</b>	

### Chromed bag holder 120 L for Jumbo trolley



REF.	NOTES
<b>3606</b>	

### Chromed bag holder 2x70 L for Jumbo trolleys and Panda art. 7221



REF.	NOTES
<b>3637</b>	

### Chromed central bag holder 120 L for Jumbo trolleys and Panda art. 7221



REF.	NOTES
<b>7169</b>	

### Chromed basket holder for Jumbo trolley



REF.	NOTES
<b>3615</b>	for basket art. 8252
<b>3624</b>	for basket art. 3638
<b>3607</b>	for basket art. 8253



ALPHA

MORGAN

CHROMED AND RILSAN COATED TROLLEYS

Tray holder for art. 8252 with handle holder for Jumbo Tank trolley



REF.	NOTES
3611	

Holder for plastic basket art. 3640



REF.	NOTES
7166	

Side plastic basket



REF.	NOTES
3640	internal dimension 40x23x11 cm

Central plastic basket



REF.	NOTES
8252	for Jumbo Tank and Master - internal dimensions 63x45x7 cm
8253	for Teddy and Jumbo Quadri - internal dimensions 44x45x7 cm
3638	for Jumbo Quick and Mini Jumbo - internal dimensions 43,5x27,5x11 cm

Chromed basket with handle holder for Jumbo Master trolley

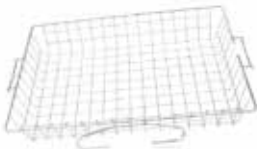

REF.	NOTES	SIZE (cm)
3612		↓ ↓ ↓ 66x48x11

Chromed basket for Jumbo trolley

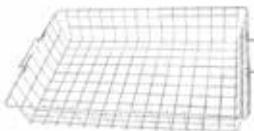

REF.	NOTES	SIZE (cm)
3601	for Jumbo Quadri	↓ ↓ ↓ 45x45x11
3610	for Jumbo Master	↓ ↓ ↓ 65x48x11

Chromed basket for Jumbo Master trolley



REF.	NOTES	SIZE (cm)
3613		↓ ↓ ↓ 66x23x11

# Multipurpose trolleys



ALPHA

MORGAN

CHROMED AND RILSAN COATED TROLLEYS

Chromed rod for basket art. 3613 for Jumbo Master trolley



REF.	NOTES
3614	

Chromed frame with 3 wheels fitting Jumbo trolleys 30 L



REF.	NOTES
3631	

Chromed wringer support for Jumbo trolley



REF.	NOTES
3600	

Chromed holder for plastic basket fitting the base of the Jumbo trolley art. 3064



REF.	NOTES
3626	

Holder for buckets 15 L for trolley art. 3061



REF.	NOTES
C3662	

Chromed basket holder for Ecology trolleys



REF.	NOTES
3647	

Chromed bucket holder for tray art. 8252



REF.	NOTES
3665	



ALPHA

MORGAN

CHROMED AND RILSAN COATED TROLLEYS

Plastic anti-spill tray for Jumbo trolley



REF.	NOTES
60234	

Chromed broom/mop holder



REF.	NOTES
8213	

Fixing clips for broom/mop holder support (2 pcs)



REF.	NOTES
8225U	

Plastic flanges with screws for vertical frame fixing



REF.	NOTES
8611U	

Plastic cover for bag holder 120 L art. 3657-R2060010- I2060010 and R2060060



REF.	NOTES
3639A	
3639B	

Plastic cover for bag holder 2x70L ref. 3637, 3659, I2060020 and R206005



REF.	NOTES
3644A	
3644B	

**PICK-UP** - plastic bin 45 L without wheels, complete with cover and screen printed plastic plate



REF.	NOTES	SIZE (cm) ↓ ↓ ↓
3667A	with image "paper"	31,5x51x30
3667B	with image "metal"	31,5x51x30
3667C	with image "plastic"	31,5x51x30
3667E	with image "non-recyclable waste"	31,5x51x30
3667F	with image "glass"	31,5x51x30
3667G	with image "organic waste"	31,5x51x30
3667T	without image	31,5x51x30

MULTIPURPOSE TROLLEYS



ALPHA

MORGAN

CHROMED AND RILSAN COATED TROLLEYS

Plastic basin 35 L



REF.	NOTES
3641A	

Pierced plastic sieve for basin 35 L



REF.	NOTES
3642	

Set with allen spanner, screws and nuts for Jumbo assembling



REF.	NOTES
8615	



ALPHA

MORGAN

CHROMED AND RILSAN COATED TROLLEYS

## Panda trolleys

### PANDA 7106 - chromed trolley



REF.	PCK	VOLUME (m³)	GROSS WEIGHT (kg)	SIZE (cm) ↓ ↓ ↓
<b>7106</b>	1	0,191	14,35	75x46x122
0000SM00115U	FLIP - handle holder with rubber roll and snap closure fitting tubes Ø22 mm			1 pc.
3640	Side plastic basket			1 pc.
7004A	REGULAR - blue plastic down-press wringer with plastic gears			1 pc.
7151	Basket holder for Panda trolleys art. 7106, 7108 and 7200			1 pc.
7152	Bag holder 120 L for Panda trolleys art. 7106 and 7200			1 pc.
7153	Chromed bag support for Panda trolley art. 7106			1 pc.
7155	Push-bar for Panda trolleys art. 7106 and 7108			1 pc.
7159	Chromed basket for bottles fitting Panda trolleys art. 7106, 7108 and 7200			1 pc.
7161CL	Chromed base with 2 wheels ø 80 mm and with 2 wheels ø 185 mm for Panda trolleys art. 7106 and 7108			1 pc.
8108B	Red plastic bucket 15 L with plastic handle			1 pc.
8218A	Blue plastic bucket 6 L with plastic handle			1 pc.
8218B	Red plastic bucket 6 L with plastic handle			1 pc.
8611U	Plastic flanges with screws for vertical frame fixing			2 pc.

#### ACCESSORIES TO ORDER AS SEPARATE ITEMS

3650B	Red plastified bag 73x97,5 cm, capacity 120 L	1 pc.
8257	Plastic cover for bag holder 120 L for Panda trolley	1 pc.

### PANDA 7108 - chromed trolley



REF.	PCK	VOLUME (m³)	GROSS WEIGHT (kg)	SIZE (cm) ↓ ↓ ↓
<b>7108</b>	1	0,191	18,57	66x46x122
0000SM00115U	FLIP - handle holder with rubber roll and snap closure fitting tubes Ø22 mm			1 pc.
3640	Side plastic basket			2 pc.
7004A	REGULAR - blue plastic down-press wringer with plastic gears			1 pc.
7151	Basket holder for Panda trolleys art. 7106, 7108 and 7200			1 pc.
7154	Basket holder for Panda trolley art. 7108			1 pc.
7155	Push-bar for Panda trolleys art. 7106 and 7108			1 pc.
7159	Chromed basket for bottles fitting Panda trolleys art. 7106, 7108 and 7200			1 pc.
7161CL	Chromed base with 2 wheels ø 80 mm and with 2 wheels ø 185 mm for Panda trolleys art. 7106 and 7108			1 pc.
8108B	Red plastic bucket 15 L with plastic handle			1 pc.
8218A	Blue plastic bucket 6 L with plastic handle			1 pc.
8218B	Red plastic bucket 6 L with plastic handle			1 pc.
8611U	Plastic flanges with screws for vertical frame fixing			2 pc.

#### ACCESSORIES TO ORDER AS SEPARATE ITEMS

60232	Transparent plastic cover for bucket 6 L	2 pc.
-------	--	-------



# Multipurpose trolleys



ALPHA

MORGAN

CHROMED AND RILSAN COATED TROLLEYS

## PANDA 7200 - chromed trolley



REF.	PCK	VOLUME (m³)	GROSS WEIGHT (kg)	SIZE (cm) ↓ ↓ ↓
<b>7200</b>	1	0,244	17,6	75x65x122

3640	Side plastic basket	1 pc.
7004A	REGULAR - blue plastic down-press wringer with plastic gears	1 pc.
7151	Basket holder for Panda trolleys art. 7106, 7108 and 7200	1 pc.
7152	Bag holder 120 L for Panda trolleys art. 7106 and 7200	1 pc.
7156	Chromed push-bar for Panda trolley art. 7200	1 pc.
7157CL	Chromed base with wheels ø 80 mm, 2 with brakes and bumpers, for Panda trolley art. 7200	1 pc.
7159	Chromed basket for bottles fitting Panda trolleys art. 7106, 7108 and 7200	1 pc.
7160CL	Chromed bag support with wheel ø 80 mm for Panda trolley art. 7200	1 pc.
7163	Chromed wringer support for Panda trolleys art. 7200 and 7221	1 pc.
8108A	Blue plastic bucket 15 L with plastic handle	1 pc.
8108B	Red plastic bucket 15 L with plastic handle	1 pc.
8218A	Blue plastic bucket 6 L with plastic handle	1 pc.
8218B	Red plastic bucket 6 L with plastic handle	1 pc.
8223U	Handle holder complete with screws for tubes ø 14 mm	1 pc.
8611U	Plastic flanges with screws for vertical frame fixing	1 pc.

### ACCESSORIES TO ORDER AS SEPARATE ITEMS

3650B	Red plastified bag 73x97,5 cm, capacity 120 L	1 pc.
60232	Transparent plastic cover for bucket 6 L	2 pc.



ALPHA

MORGAN

CHROMED AND RILSAN COATED TROLLEYS

## Components and accessories for Panda trolleys

Chromed base with 2 wheels  $\varnothing$  80 mm and with 2 wheels  $\varnothing$  185 mm for Panda trolleys art. 7106 and 7108



REF.	NOTES
7161CL	

Push-bar for Panda trolleys art. 7106 and 7108



REF.	NOTES
7155	

Bag holder 120 L for Panda trolleys art. 7106 and 7200



REF.	NOTES
7152	

Basket holder for Panda trolleys art. 7106, 7108 and 7200



REF.	NOTES
7151	

Basket holder for Panda trolley art. 7108



REF.	NOTES
7154	

Chromed basket for bottles fitting Panda trolleys art. 7106, 7108 and 7200



REF.	NOTES
7159	

Chromed bag support for Panda trolley art. 7106



REF.	NOTES
7153	

# Multipurpose trolleys



ALPHA

MORGAN

CHROMED AND RILSAN COATED TROLLEYS

Chromed base with wheels  $\varnothing$  80 mm, 2 with brakes and bumpers, for Panda trolley art. 7200



REF.	NOTES
7157CL	

Chromed push-bar for Panda trolley art. 7200



REF.	NOTES
7156	

Chromed bag support with wheel  $\varnothing$  80 mm for Panda trolley art. 7200



REF.	NOTES
7160CL	

Chromed wringer support for Panda trolleys art. 7200 and 7221



REF.	NOTES
7163	

Chromed base with wheels  $\varnothing$  80 mm, 2 with brakes and bumpers, for Panda trolley art. 7221



REF.	NOTES
7164CL	

Chromed vertical frame for Panda trolley art. 7221



REF.	NOTES
7165	

Holder for plastic basket art. 3640



REF.	NOTES
7166	



ALPHA

MORGAN

CHROMED AND RILSAN COATED TROLLEYS

Chromed basket for Panda trolley art. 7221



REF.	NOTES	SIZE (cm) ↓ ↓ ↓
7170		41x13,5x11

Chromed bag holder 2x70 L for Jumbo trolleys and Panda art. 7221



REF.	NOTES
3637	

Chromed central bag holder 120 L for Jumbo trolleys and Panda art. 7221



REF.	NOTES
7169	

Bag support with wheel ø 80 mm for Panda trolley art. 7221



REF.	NOTES
7167CL	

Side plastic basket



REF.	NOTES
3640	internal dimension 40x23x11 cm



Plastic tray for the base of the trolleys art. 8049, Teddy 8090X-8098X and Panda



REF.	NOTES	SIZE (cm) ↓ ↓ ↓
8227		39,5x59x2,5

Plastic cover for bag holder 2x70L ref. 3637, 3659, I2060020 and R206005



REF.	NOTES
3644A	
3644B	

MULTIPURPOSE TROLLEYS

# Multipurpose trolleys



ALPHA

MORGAN

CHROMED AND RILSAN COATED TROLLEYS

Plastic cover for bag holder 120 L for Panda trolley



REF.	NOTES
8257	

Chromed broom/mop holder



REF.	NOTES
8213	

Plastic flanges with screws for vertical frame fixing



REF.	NOTES
8611U	

Plastic bag fixing clip



REF.	NOTES
8220A	



# A-B PLUS anti-bacterial system



A-B PLUS



## A-B PLUS



# 100% recyclable



**A-B Plus** is a complete cleaning system whose components have been treated with anti-bacterial additives in order to slow down the growth of bacteria, molds and fungi.

This cleaning system uses silver ion technology for microfiber and for some plastic components and Zinc Pyrithione for Alpha trolleys and their components.

The anti-bacterial additive, mixed during the production process, is part of the polymeric matrice and penetrates the cell wall of the micro-organism blocking its growth and reproduction functions.

The anti-bacterial treatment can be **guaranteed for the whole life cycle** of the product.

### Better hygiene and safety for everyone

- For end users: patients, children, old people, consumers
- For professional people: doctors, nurses, teachers and food operators
- For cleaning operators
- For environment

### A sanitization cleaning system for hospitals... and more than that

- Hospitals: both low-risk common areas and high-risk areas, such as operating theatres, infection disease wards, intensive care wards and similar environments
- Nursing homes
- Public facilities: schools, nursery schools, food industries, banks, airports, railway stations



Tested by CHELAB srl  
via Fratta, 25 31023  
Resana (TV) Italy, ac-  
cording to ISO 22196-  
2011



Tested by SGS, ac-  
cording to ISO 20743-  
2007

## A-B PLUS

### Alpha A-B PLUS trolleys

#### ALPHA A-B PLUS 0503700 - plastic anti-bacterial trolley



REF.	PCK	VOLUME (m <sup>3</sup> )	GROSS WEIGHT (kg)	SIZE (cm) ↓ ↓ ↓
<b>MZ0503700Z000</b>	1	0,372	25,37	118x58x112
0000SE0104FAZ	Anti-bacterial plastic bucket 4 L with blue upper plastic handle	1 pc.		
0000SE0104FBZ	Anti-bacterial plastic bucket 4 L with red upper plastic handle	1 pc.		
0000SE0104FCZ	Anti-bacterial plastic bucket 4 L with yellow upper plastic handle	1 pc.		
0000SE0104FFZ	Anti-bacterial plastic bucket 4 L with green upper plastic handle	1 pc.		
0000SE1322FAZ	TOP-DOWN - green antibacterial plastic bucket with blue plastic handle and watertight lid, 20 l	1 pc.		
0000SE1322FBZ	TOP-DOWN - green antibacterial plastic bucket with red plastic handle and watertight lid, 20 l	1 pc.		
0000SM00165Z	Anti-bacterial set of T-shaped closing plugs for vertical frames (6 pcs)	2 pc.		
020P2199906EZ	Central antibacterial plastic tray, female/female fitting, with plugs	1 pc.		
P066031EZ	Anti-bacterial long plastic base with rubber wheels ø 125 mm for Alpha trolley	1 pc.		
P1191100EZ	Anti-bacterial side plastic basket	2 pc.		
P1229906FZ	Anti-bacterial plastic sliding drawer 22 L without locking key	1 pc.		
P2039903FZ	Anti-bacterial vertical frame, 1 side with 6 slides + 1 side for T-plugs, complete with screws and plugs	2 pc.		
P2909920EZ	Anti-bacterial closing profile for central basket/bag holder complete with screws and plugs	1 pc.		
P8161114EZ	2x60 antibacterial plastic waste bag holder, male fitting, with handle clip, dustpan hook, pistons, screws and plugs	1 pc.		

#### ACCESSORIES TO ORDER AS SEPARATE ITEMS

0000AT0170A	Blue plastified bag 48x95 cm, capacity 60 L	1 pc.
0000AT0170B	Red plastic-coated bag 48x95 cm, maximum capacity 60 L	1 pc.
0000CP1204FZ	Green anti-bacterial plastic cover with hinges for buckets 4 L art. 0000SE0104	4 pcs
P190908U	Shock absorbing piston for a soft closing of the cover	2 pc.
P291918FZ	Green anti-bacterial plastic cover for bag holder 120 L	1 pc.

#### ALPHA A-B PLUS 0603700 - plastic anti-bacterial trolley

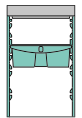

REF.	PCK	VOLUME (m <sup>3</sup> )	GROSS WEIGHT (kg)	SIZE (cm) ↓ ↓ ↓
<b>MZ0603700Z000</b>	1	0,372	27,67	118x58x112
0000SE0104FAZ	Anti-bacterial plastic bucket 4 L with blue upper plastic handle	1 pc.		
0000SE0104FBZ	Anti-bacterial plastic bucket 4 L with red upper plastic handle	1 pc.		
0000SE0104FCZ	Anti-bacterial plastic bucket 4 L with yellow upper plastic handle	1 pc.		
0000SE0104FFZ	Anti-bacterial plastic bucket 4 L with green upper plastic handle	1 pc.		
0000SE1322FAZ	TOP-DOWN - green antibacterial plastic bucket with blue plastic handle and watertight lid, 20 l	1 pc.		
0000SE1322FBZ	TOP-DOWN - green antibacterial plastic bucket with red plastic handle and watertight lid, 20 l	1 pc.		
0000SM00165Z	Anti-bacterial set of T-shaped closing plugs for vertical frames (6 pcs)	2 pc.		
020P2199906EZ	Central antibacterial plastic tray, female/female fitting, with plugs	1 pc.		
P066031EZ	Anti-bacterial long plastic base with rubber wheels ø 125 mm for Alpha trolley	1 pc.		
P1191100EZ	Anti-bacterial side plastic basket	2 pc.		
P1229906FZ	Anti-bacterial plastic sliding drawer 22 L without locking key	1 pc.		
P2039903FZ	Anti-bacterial vertical frame, 1 side with 6 slides + 1 side for T-plugs, complete with screws and plugs	2 pc.		
P2909920EZ	Anti-bacterial closing profile for central basket/bag holder complete with screws and plugs	1 pc.		
P3909953FZ	Anti-bacterial fixed side wall with fixing pins	1 pc.		
P3909954FZ	Plastic antibacterial door with fixing pins	1 pc.		
P8161114EZ	2x60 antibacterial plastic waste bag holder, male fitting, with handle clip, dustpan hook, pistons, screws and plugs	1 pc.		

#### ACCESSORIES TO ORDER AS SEPARATE ITEMS

0000AT0170A	Blue plastified bag 48x95 cm, capacity 60 L	1 pc.
0000AT0170B	Red plastic-coated bag 48x95 cm, maximum capacity 60 L	1 pc.
0000CP1204FZ	Green anti-bacterial plastic cover with hinges for buckets 4 L art. 0000SE0104	4 pcs
P190908U	Shock absorbing piston for a soft closing of the cover	2 pc.
P291918FZ	Green anti-bacterial plastic cover for bag holder 120 L	1 pc.



# A-B PLUS anti-bacterial system



## A-B PLUS

### ALPHA A-B PLUS 3603701 - plastic anti-bacterial trolley

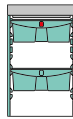

### ALPHA A-B PLUS 1603702 - plastic anti-bacterial trolley

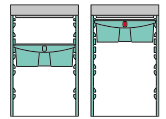

REF.	PCK	VOLUME (m <sup>3</sup> )	GROSS WEIGHT (kg)	SIZE (cm)
<b>MZ3603701Z000</b>	1	0,372	27,37	118x58x110

0000SE0204FAZ	Anti-bacterial grey plastic bucket 4 L with blue upper plastic handle	1 pc.
0000SE0204FBZ	Anti-bacterial grey plastic bucket 4 L with red upper plastic handle	1 pc.
0000SE0204FCZ	Anti-bacterial grey plastic bucket 4 L with yellow upper plastic handle	1 pc.
0000SE0204FFZ	Anti-bacterial grey plastic bucket 4 L with green upper plastic handle	1 pc.
0000SE1322FAZ	TOP-DOWN - green antibacterial plastic bucket with blue plastic handle and watertight lid, 20 l	1 pc.
0000SM00165Z	Anti-bacterial set of T-shaped closing plugs for vertical frames (6 pcs)	2 pc.
P066031EZ	Anti-bacterial long plastic base with rubber wheels ø 125 mm for Alpha trolley	1 pc.
P1229906FZ	Anti-bacterial plastic sliding drawer 22 L without locking key	1 pc.
P165000EZ	Anti-bacterial supporting plastic plate for bases Alpha trolley	1 pc.
P1909937EZ	Anti-bacterial plastic lift for buckets, with holes for bottles, fitting drawers 22 and 40 L	1 pc.
P2039903FZ	Anti-bacterial vertical frame, 1 side with 6 slides + 1 side for T-plugs, complete with screws and plugs	2 pc.
P2229906FZ	Anti-bacterial plastic sliding drawer 22 L with locking key	1 pc.
P2909920EZ	Anti-bacterial closing profile for central basket/bag holder complete with screws and plugs	1 pc.
P3199903EZ	Antibacterial plastic central ring for 4l buckets complete with lockable lid and two soft-close pistons	1 pc.
P3909953FZ	Anti-bacterial fixed side wall with fixing pins	1 pc.
P3909954FZ	Plastic antibacterial door with fixing pins	1 pc.
P8161114EZ	2x60 antibacterial plastic waste bag holder, male fitting, with handle clip, dustpan hook, pistons, screws and plugs	1 pc.

#### ACCESSORIES TO ORDER AS SEPARATE ITEMS

0000AT0170A	Blue plastified bag 48x95 cm, capacity 60 L	1 pc.
0000AT0170B	Red plastic-coated bag 48x95 cm, maximum capacity 60 L	1 pc.
P190908U	Shock absorbing piston for a soft closing of the cover	2 pc.
P291918FZ	Green anti-bacterial plastic cover for bag holder 120 L	1 pc.

REF.	PCK	VOLUME (m <sup>3</sup> )	GROSS WEIGHT (kg)	SIZE (cm)
<b>MZ1603702Z000</b>	1	0,488	31,64	120x58x110

0000SE0204FAZ	Anti-bacterial grey plastic bucket 4 L with blue upper plastic handle	1 pc.
0000SE0204FBZ	Anti-bacterial grey plastic bucket 4 L with red upper plastic handle	1 pc.
0000SE0204FCZ	Anti-bacterial grey plastic bucket 4 L with yellow upper plastic handle	1 pc.
0000SE0204FFZ	Anti-bacterial grey plastic bucket 4 L with green upper plastic handle	1 pc.
0000SE1322FAZ	TOP-DOWN - green antibacterial plastic bucket with blue plastic handle and watertight lid, 20 l	1 pc.
0000SM00165Z	Anti-bacterial set of T-shaped closing plugs for vertical frames (6 pcs)	2 pc.
020P2199907EZ	Anti-bacterial central plastic basket (male-female version) complete with screws and caps	1 pc.
P066031EZ	Anti-bacterial long plastic base with rubber wheels ø 125 mm for Alpha trolley	1 pc.
P1229906FZ	Anti-bacterial plastic sliding drawer 22 L without locking key	1 pc.
P165000EZ	Anti-bacterial supporting plastic plate for bases Alpha trolley	1 pc.
P1909937EZ	Anti-bacterial plastic lift for buckets, with holes for bottles, fitting drawers 22 and 40 L	1 pc.
P2039903FZ	Anti-bacterial vertical frame, 1 side with 6 slides + 1 side for T-plugs, complete with screws and plugs	2 pc.
P2039904FZ	Anti-bacterial vertical frame, 2 sides with slides, complete with screws and plugs	1 pc.
P2229906FZ	Anti-bacterial plastic sliding drawer 22 L with locking key	1 pc.
P2909920EZ	Anti-bacterial closing profile for central basket/bag holder complete with screws and plugs	1 pc.
P2909921EZ	Anti-bacterial closing profile with push-grip for central basket complete with screws and plugs	1 pc.
P3199903EZ	Antibacterial plastic central ring for 4l buckets complete with lockable lid and two soft-close pistons	1 pc.
P3909953FZ	Anti-bacterial fixed side wall with fixing pins	2 pc.
P3909954FZ	Plastic antibacterial door with fixing pins	2 pc.

## A-B PLUS

### ALPHA A-B PLUS 0803700 - plastic anti-bacterial trolley



### ALPHA A-B PLUS 0803701 - plastic anti-bacterial trolley



REF.	PCK	VOLUME (m³)	GROSS WEIGHT (kg)	SIZE (cm) ↓ ↓ ↓
<b>MZ0803700Z00</b>	1	0,488	27,34	120x58x112
0000SE0104FAZ	Anti-bacterial plastic bucket 4 L with blue upper plastic handle	1 pc.		
0000SE0104FBZ	Anti-bacterial plastic bucket 4 L with red upper plastic handle	1 pc.		
0000SE0104FCZ	Anti-bacterial plastic bucket 4 L with yellow upper plastic handle	1 pc.		
0000SE0104FFZ	Anti-bacterial plastic bucket 4 L with green upper plastic handle	1 pc.		
0000SE1322FAZ	TOP-DOWN - green antibacterial plastic bucket with blue plastic handle and watertight lid, 20 l	1 pc.		
0000SE1322FBZ	TOP-DOWN - green antibacterial plastic bucket with red plastic handle and watertight lid, 20 l	1 pc.		
0000SM00165Z	Anti-bacterial set of T-shaped closing plugs for vertical frames (6 pcs)	2 pc.		
020P2199906EZ	Central antibacterial plastic tray, female/female fitting, with plugs	1 pc.		
60072EZ	Anti-bacterial handle holder for Alpha bag holder and closing profile	2 pc.		
60082EZ	Anti-bacterial hook	1 pc.		
P066031EZ	Anti-bacterial long plastic base with rubber wheels ø 125 mm for Alpha trolley	1 pc.		
P1191100EZ	Anti-bacterial side plastic basket	2 pc.		
P1229906FZ	Anti-bacterial plastic sliding drawer 22 L without locking key	1 pc.		
P190908U	Shock absorbing piston for a soft closing of the cover	2 pc.		
P2039903FZ	Anti-bacterial vertical frame, 1 side with 6 slides + 1 side for T-plugs, complete with screws and plugs	2 pc.		
P2909912EZ	Divider for plastic anti-bacterial bag holder 150 L	1 pc.		
P2909920EZ	Anti-bacterial closing profile for central basket/bag holder complete with screws and plugs	1 pc.		
P2909946FZ	Anti-bacterial plastic cover for bag holder 150 L with check-list holder	1 pc.		
P3909952FZ	Plastic antibacterial door for bag holder, with fixing pins	1 pc.		
P3909953FZ	Anti-bacterial fixed side wall with fixing pins	2 pc.		
P8169905EZ	150l antibacterial plastic waste bag holder, male fitting, with 2 pistons, screws and plugs	1 pc.		

#### ACCESSORIES TO ORDER AS SEPARATE ITEMS

0000AT0160A	Blue plastic-coated bag 57x98 cm, maximum capacity 80 L	1 pc.
0000AT0160B	Red plastified bag 57x98 cm, capacity 80 L	1 pc.
0000CP1204FZ	Green anti-bacterial plastic cover with hinges for buckets 4 L art. 0000SE0104	4 pcs
P2909918FZ	Anti-bacterial pedal set for Alpha trolleys with long base, closed bag holder 150 L and wheels ø 125 mm	1 pc.

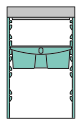

REF.	PCK	VOLUME (m³)	GROSS WEIGHT (kg)	SIZE (cm) ↓ ↓ ↓
<b>MZ0803701Z00</b>	1	0,372	30,87	120x58x112
0000SE0104FAZ	Anti-bacterial plastic bucket 4 L with blue upper plastic handle	1 pc.		
0000SE0104FBZ	Anti-bacterial plastic bucket 4 L with red upper plastic handle	1 pc.		
0000SE0104FCZ	Anti-bacterial plastic bucket 4 L with yellow upper plastic handle	1 pc.		
0000SE0104FFZ	Anti-bacterial plastic bucket 4 L with green upper plastic handle	1 pc.		
0000SE1322FAZ	TOP-DOWN - green antibacterial plastic bucket with blue plastic handle and watertight lid, 20 l	1 pc.		
0000SE1322FBZ	TOP-DOWN - green antibacterial plastic bucket with red plastic handle and watertight lid, 20 l	1 pc.		
0000SM00165Z	Anti-bacterial set of T-shaped closing plugs for vertical frames (6 pcs)	2 pc.		
020P2199906EZ	Central antibacterial plastic tray, female/female fitting, with plugs	1 pc.		
60072EZ	Anti-bacterial handle holder for Alpha bag holder and closing profile	2 pc.		
60082EZ	Anti-bacterial hook	1 pc.		
P066031EZ	Anti-bacterial long plastic base with rubber wheels ø 125 mm for Alpha trolley	1 pc.		
P1191100EZ	Anti-bacterial side plastic basket	2 pc.		
P1229906FZ	Anti-bacterial plastic sliding drawer 22 L without locking key	1 pc.		
P190908U	Shock absorbing piston for a soft closing of the cover	2 pc.		
P2039903FZ	Anti-bacterial vertical frame, 1 side with 6 slides + 1 side for T-plugs, complete with screws and plugs	2 pc.		
P2909912EZ	Divider for plastic anti-bacterial bag holder 150 L	1 pc.		
P2909920EZ	Anti-bacterial closing profile for central basket/bag holder complete with screws and plugs	1 pc.		
P2909946FZ	Anti-bacterial plastic cover for bag holder 150 L with check-list holder	1 pc.		
P3909952FZ	Plastic antibacterial door for bag holder, with fixing pins	1 pc.		
P3909953FZ	Anti-bacterial fixed side wall with fixing pins	3 pcs		
P3909954FZ	Plastic antibacterial door with fixing pins	1 pc.		
P8169905EZ	150l antibacterial plastic waste bag holder, male fitting, with 2 pistons, screws and plugs	1 pc.		

#### ACCESSORIES TO ORDER AS SEPARATE ITEMS

0000AT0160A	Blue plastic-coated bag 57x98 cm, maximum capacity 80 L	1 pc.
0000AT0160B	Red plastified bag 57x98 cm, capacity 80 L	1 pc.
0000CP1204FZ	Green anti-bacterial plastic cover with hinges for buckets 4 L art. 0000SE0104	4 pcs
P2909918FZ	Anti-bacterial pedal set for Alpha trolleys with long base, closed bag holder 150 L and wheels ø 125 mm	1 pc.

# A-B PLUS anti-bacterial system



## A-B PLUS

### ALPHA A-B PLUS 3803702- plastic anti-bacterial trolley

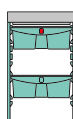

REF.	PCK	VOLUME (m <sup>3</sup> )	GROSS WEIGHT (kg)	SIZE (cm)
<b>MZ3803702Z000</b>	1	0,488	30,76	120x58x110

0000SE0204FAZ	Anti-bacterial grey plastic bucket 4 L with blue upper plastic handle	1 pc.
0000SE0204FBZ	Anti-bacterial grey plastic bucket 4 L with red upper plastic handle	1 pc.
0000SE0204FCZ	Anti-bacterial grey plastic bucket 4 L with yellow upper plastic handle	1 pc.
0000SE0204FFZ	Anti-bacterial grey plastic bucket 4 L with green upper plastic handle	1 pc.
0000SE1322FAZ	TOP-DOWN - green antibacterial plastic bucket with blue plastic handle and watertight lid, 20l	1 pc.
0000SM00165Z	Anti-bacterial set of T-shaped closing plugs for vertical frames (6 pcs)	2 pc.
60072EZ	Anti-bacterial handle holder for Alpha bag holder and closing profile	2 pc.
60082EZ	Anti-bacterial hook	1 pc.
P066031EZ	Anti-bacterial long plastic base with rubber wheels ø 125 mm for Alpha trolley	1 pc.
P1229906FZ	Anti-bacterial plastic sliding drawer 22 L without locking key	1 pc.
P165000EZ	Anti-bacterial supporting plastic plate for bases Alpha trolley	1 pc.
P190908U	Shock absorbing piston for a soft closing of the cover	2 pc.
P1909937EZ	Anti-bacterial plastic lift for buckets, with holes for bottles, fitting drawers 22 and 40 L	1 pc.
P2039903FZ	Anti-bacterial vertical frame, 1 side with 6 slides + 1 side for T-plugs, complete with screws and plugs	2 pc.
P2229906FZ	Anti-bacterial plastic sliding drawer 22 L with locking key	1 pc.
P2909912EZ	Divider for plastic anti-bacterial bag holder 150 L	1 pc.
P2909920EZ	Anti-bacterial closing profile for central basket/bag holder complete with screws and plugs	1 pc.
P2909946FZ	Anti-bacterial plastic cover for bag holder 150 L with check-list holder	1 pc.
P3199903EZ	Antibacterial plastic central ring for 4l buckets complete with lockable lid and two soft-close pistons	1 pc.
P3909952FZ	Plastic antibacterial door for bag holder, with fixing pins	1 pc.
P3909953FZ	Anti-bacterial fixed side wall with fixing pins	3 pcs
P3909954FZ	Plastic antibacterial door with fixing pins	1 pc.
P8169905EZ	150l antibacterial plastic waste bag holder, male fitting, with 2 pistons, screws and plugs	1 pc.

### ACCESSORIES TO ORDER AS SEPARATE ITEMS

0000AT0160A	Blue plastic-coated bag 57x98 cm, maximum capacity 80 L	1 pc.
0000AT0160B	Red plastified bag 57x98 cm, capacity 80 L	1 pc.
P2909918FZ	Anti-bacterial pedal set for Alpha trolleys with long base, closed bag holder 150 L and wheels ø 125 mm	1 pc.

## A-B PLUS

### Mop holders, mops and cloths for A-B PLUS system

#### UNIKO - foldable anti-bacterial plastic mop holder with mop fixing clip and Lock System



REF.	NOTES	PCK	VOLUME (m³)	GROSS WEIGHT (kg)	SIZE (cm) ↓ ↓ ↓
0000TD0320FZ		10	0,024	5,69	40x11

#### Mop A-B PLUS anti-bacterial microfiber pocket mop



REF.	NOTES	PCK	VOLUME (m³)	GROSS WEIGHT (kg)	SIZE (cm) ↓ ↓ ↓
0000PN04012EZ		25	0,028	3,32	40x13

#### MULTI-T - anti-bacterial microfiber multipurpose cloth



REF.	NOTES	PCK	VOLUME (m³)	GROSS WEIGHT (kg)	SIZE (cm) ↓ ↓ ↓
TCH101410		5	0,002	0,28	40x40
TCH101420		5	0,002	0,28	40x40
TCH101430		5	0,002	0,28	40x40
TCH101440		5	0,002	0,28	40x40
TCH101419	pck.: 40 polybags with 5 pcs	1	0,08	11,6	40x40
TCH101429	pck.: 40 polybags with 5 pcs	1	0,08	11,6	40x40
TCH101439	pck.: 40 polybags with 5 pcs	1	0,08	11,6	40x40
TCH101449	pck.: 40 polybags with 5 pcs	1	0,08	11,6	40x40

With anti-bacterial treatment, it removes up to 99,98% of bacteria and fungi - Cloth for any surface and for very dirty environments - Resistant, it removes and keeps dirt - Weight: 300 gr/Sq m

### A-B PLUS handles

#### Anodized aluminium telescopic handle with anti-bacterial components - 2 pcs



REF.	NOTES	PCK	VOLUME (m³)	GROSS WEIGHT (kg)	SIZE (cm) ↓ ↓ ↓
0000AM3040FZ		10	0,014	4,69	182

Extendible form 100 to 182 cm - External tube ø 26 mm, internal tube ø 23 mm

# A-B PLUS anti-bacterial system



## A-B PLUS

**MOVE** - plastic anti-bacterial handle holder for handles  $\varnothing$  26 mm



REF.	NOTES
<b>000SM00147FZ</b>	

## Components and accessories A-B PLUS

Anti-bacterial long plastic base for Alpha trolley



REF.	NOTES	SIZE (cm) ↓ ↓ ↓
<b>P066031EZ</b>	with rubber wheels $\varnothing$ 125 mm	91x52

Anti-bacterial supporting plastic plate for bases Alpha trolley



REF.	NOTES	SIZE (cm) ↓ ↓ ↓
<b>P165000EZ</b>		48x22x15

Anti-bacterial vertical frame, 1 side with 6 slides + 1 side for T-plugs, complete with screws and plugs



REF.	NOTES
<b>P2039903FZ</b>	

Anti-bacterial vertical frame, 2 sides with slides, complete with screws and plugs



REF.	NOTES
<b>P2039904FZ</b>	

Anti-bacterial set of T-shaped closing plugs for vertical frames (6 pcs)



REF.	NOTES
<b>000SM00165Z</b>	

## A-B PLUS

### Anti-bacterial fixed side wall with fixing pins



REF.	NOTES
<b>P3909953FZ</b>	

### Plastic antibacterial door with fixing pins



REF.	NOTES
<b>P3909954FZ</b>	

### Antibacterial plastic door for 150l waste bag holder, with fastening pins



REF.	NOTES
<b>P3909952FZ</b>	

### Anti-bacterial central plastic basket (female-female version) complete with caps



REF.	NOTES
<b>020P2199906EZ</b>	internal dimension 48x31x8 cm

### Anti-bacterial central plastic basket (male-female version) complete with screws and caps

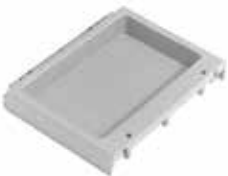

REF.	NOTES
<b>020P2199907EZ</b>	internal dimension 48x31x8 cm

### Anti-bacterial central plastic frame with cover with locking key and 2 shock absorbing pistons for versions with buckets 4 L



REF.	NOTES
<b>P3199903EZ</b>	

# A-B PLUS anti-bacterial system



## A-B PLUS

### Anti-bacterial side plastic basket



REF.	NOTES
<b>P1191100EZ</b>	external dimension 49x22x11,5 cm

### Anti-bacterial closing profile for central basket/bag holder complete with screws and plugs



REF.	NOTES
<b>P2909920EZ</b>	

### Anti-bacterial closing profile with push-grip for central basket complete with screws and plugs



REF.	NOTES
<b>P2909921EZ</b>	

### 2x60 antibacterial plastic waste bag holder, male fitting, with 2 handle clips, 2 fixed dustpan hooks, 2 pistons for soft-close lid, screws and plugs



REF.	NOTES
<b>P8161114EZ</b>	

### 150L antibacterial plastic waste bag holder, male fitting, with 2 pistons for soft-close lid, screws and plugs



REF.	NOTES
<b>P8169905EZ</b>	

### Divider for plastic anti-bacterial bag holder 150 L



REF.	NOTES
<b>P2909912EZ</b>	

## A-B PLUS

### Anti-bacterial plastic sliding drawer without locking key



REF.	NOTES	CAPACITY (L)
P1229906FZ	internal dimensions 40,5x34x16 cm	22
P1229907FZ	internal dimensions 40x34x33,5 cm	40

### Anti-bacterial plastic slider drawer with locking key



REF.	NOTES	CAPACITY (L)
P2229906FZ	internal dimensions 40,5x34x16 cm	22
P2229907FZ	internal dimensions 40x34x33,5 cm	40

### Anti-bacterial plastic lift for buckets, with holes for bottles, fitting drawers 22 and 40 L



REF.	NOTES
P1909937EZ	

### Anti-bacterial pedal set for Alpha trolleys with long base, closed bag holder 150 L and wheels ø 125 mm



REF.	NOTES
P2909918FZ	

### Anti-bacterial plastic cover for bag holder 120 L



REF.	NOTES
P291918FZ	



Please, require also no. 2 shock absorbing pistons art. P190908U for a perfect soft closing

### Anti-bacterial plastic cover for bag holder 150 L with check-list holder



REF.	NOTES
P2909946FZ	





# A-B PLUS anti-bacterial system



## A-B PLUS

Please, require also no. 2 shock absorbing pistons art. P190908U for a perfect soft closing

Shock absorbing piston for a soft closing of the cover







REF.	NOTES
P190908U	







Anti-bacterial green plastic bucket 4 L with coloured plastic handle



REF.	NOTES		SIZE (cm) ↓ ↓ ↓
0000SE0104FAZ	with blue handle		25,5x17x19,5
0000SE0104FBZ	with red handle		25,5x17x19,5
0000SE0104FCZ	with yellow handle		25,5x17x19,5
0000SE0104FFZ	with green handle		25,5x17x19,5

Anti-bacterial green plastic bucket 4 L with coloured upper plastic handle



REF.	NOTES		SIZE (cm) ↓ ↓ ↓
0000SE0204FAZ	with blue handle		21x16,5x22,5
0000SE0204FBZ	with red handle		21x16,5x22,5
0000SE0204FCZ	with yellow handle		21x16,5x22,5
0000SE0204FFZ	with green handle		21x16,5x22,5



Green anti-bacterial plastic cover with hinges



REF.	NOTES
0000CP1204FZ	for bucket 4 L art. 0000SE0104

TOP-DOWN® - anti-bacterial green plastic bucket with coloured plastic handle and hermetic cover



REF.	NOTES		CAPACITY (L)	SIZE (cm) ↓ ↓ ↓
0000SE1322FAZ	with blue handle		20	55x24x27
0000SE1322FBZ	with red handle		20	55x24x27

Anti-bacterial plastic divider for Top-Down® bucket 20 L



REF.	NOTES
P190350FZ	



**A-B PLUS**

Anti-bacterial pierced plastic sieve for Top-Down® bucket 20 L



REF.	NOTES
<b>P119004FZ</b>	

Anti-bacterial handle holder for Alpha bag holder and closing profile



REF.	NOTES
<b>60072EZ</b>	

Anti-bacterial hook



REF.	NOTES
<b>60082EZ</b>	



# Housekeeping trolleys



Emotion

Morgan Hotel Elegance

Alpha Hotel

Silver

Trolleys for laundry collection





EMOTION

MORGAN HOTEL ELEGANCE

ALPHA HOTEL

SILVER

TROLLEYS FOR LAUNDRY COLLECTION

## Emotion: a new way to communicate through room service trolleys

**Emotion** is Filmop line of trolleys for general and professional cleaning in hotels. Emotion trolleys are **handy, strong**, extremely modular and made of high quality polypropylene materials, from the base to the vertical frames, to the shelves and all other accessories. Open or completely closed models are available to guarantee **the highest hygiene** and **the utmost security**. Moreover, thanks to their doors these trolleys always keep a clean and tidy look.

Next to their functionality, Emotion trolleys are characterized by their elegant, simple and pleasant design, enriched by a **new elegant graphics**.

Elegance and style match perfectly together with plainness and efficiency. Thanks to its several components Emotion trolley can be fully accessorized and, consequently, it is ideal for any cleaning need; not only for the change of dirty clean linen, but also for room and bathroom cleaning, for waste collection and mini-bar refilling.

A very close and accurate research and planning have developed a line of trolleys that can be customized with images, special designs, pictures or brands, thus transforming, in a very completely original way, a simple service trolley into an advertising vehicle or into a trolley perfectly fitting the surrounding environment.



### Some details about the Emotion line:



Base with 5 rubber wheels Ø 125 mm to increase



Bag holder with bumpers.



Door with locking system with removable key and with ergonomic hand grip



Customizable design

## **NEW** Emotion Drive motor-driven service trolleys



Thanks to the possibility of moving heavy loads without strain, Emotion Drive trolleys **make cleaning easier and quicker**.

The range of motor-driven service trolleys makes it possible to tackle all kinds of up or down sloping floors in **full safety** and **without causing disturbance**.

- Loading capacity up to 150 kg
- Freedom of movement with slopes up to 12°
- Adjustable travel speed between 2 and 4.5 km/h
- Intuitive and easy to use console
- Up to 8 hours of use with one charge
- USB mobile phone and tablet charging port

### Some features of the Emotion Drive range



Insertion of the key in the console and switching on



**FORWARD** travel button



**REVERSE** travel button



**STOP** button (forward/reverse travel)

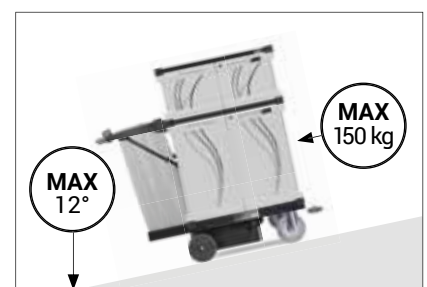

# Housekeeping trolleys



EMOTION

MORGAN HOTEL ELEGANCE

ALPHA HOTEL

SILVER

TROLLEYS FOR LAUNDRY COLLECTION

## Emotion Drive

### EMOTION DRIVE 0400020PE - plastic trolley

**NEW**



### EMOTION DRIVE 0304020PE - plastic trolley

**NEW**

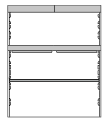

REF.	PCK	VOLUME (m³)	GROSS WEIGHT (kg)	SIZE (cm) ↓ ↓ ↓
<b>SE0400020PE02</b>	1	1,71	72,7	110x64x110,5
0000SM00165	Set of T-shaped light grey closing plugs for vertical frames (6 pcs)	2 pc.		
P1229906U	Grey plastic sliding drawer 22 L without locking key	2 pc.		
P1229907U	Grey plastic sliding drawer 40 L without locking key	2 pc.		
P130001Q	Door stopper made of plastic and rubber	1 pc.		
P1918802E	Big fixed side wall	2 pc.		
P2038805E	Big vertical frame, 1 side for T-plugs + 1 side with slides, complete with screws	2 pc.		
P2328801Q	Big fixed shelf with seat for vertical frame	1 pc.		
P266481Q	Long base with 2 ø 200x45 mm wheels, 4 bumpers and motor kit	1 pc.		
P3038804E	Big vertical frame, 2 sides with slides, complete with screws	1 pc.		
P3229915U	Grey pull-out plastic tray with slide out limiter and removable locking key	2 pc.		
P3908835Q	Right closing profile with push-grip for Emotion trolleys with door	1 pc.		
P3908836Q	Left closing profile with push-grip for Emotion trolleys with door	1 pc.		
P3928802E	Big right door with lock and assembling kit	1 pc.		
P3938802E	Big left door with assembling kit	1 pc.		

#### ACCESSORIES TO ORDER AS SEPARATE ITEMS

00BL1000	Lithium battery	1 pc.
----------	-----------------	-------

Suggested for 8 to 10 rooms

#### ON REQUEST, WITH SURCHARGE



wheels with rubber tyres for exterior use ø 200x50 mm

TROLLEY REF.  
**SE0400020KE02**

REF.	PCK	VOLUME (m³)	GROSS WEIGHT (kg)	SIZE (cm) ↓ ↓ ↓
<b>SE0304020PE00</b>	1	1,71	77	110x64x149,5
0000SM00165	Set of T-shaped light grey closing plugs for vertical frames (6 pcs)	2 pc.		
P130001Q	Door stopper made of plastic and rubber	1 pc.		
P1908839E	Side-walls blocking device	1 pc.		
P1918802E	Big fixed side wall	2 pc.		
P1948802E	Small fixed side wall	2 pc.		
P2038805E	Big vertical frame, 1 side for T-plugs + 1 side with slides, complete with screws	2 pc.		
P2038806E	Small vertical frame, 1 smooth side + 1 side with slides	2 pc.		
P2228800Q	Long smooth fixed shelf	1 pc.		
P2229911Q	Long pull-out shelf	1 pc.		
P266481Q	Long base with 2 ø 200x45 mm wheels, 4 bumpers and motor kit	1 pc.		
P2908822Q	Right closing profile for Emotion trolleys with door	1 pc.		
P2908823Q	Left closing profile for Emotion trolleys with door	1 pc.		
P3228800QU	Long smooth fixed shelf with central tray support	1 pc.		
P3229915U	Grey pull-out plastic tray with slide out limiter and removable locking key	2 pc.		
P3908835Q	Right closing profile with push-grip for Emotion trolleys with door	1 pc.		
P3908836Q	Left closing profile with push-grip for Emotion trolleys with door	1 pc.		
P3928802E	Big right door with lock and assembling kit	1 pc.		
P3938802E	Big left door with assembling kit	1 pc.		
P3958802E	Small right door with lock and assembling kit	1 pc.		
P3968802E	Small left door with assembling kit	1 pc.		

#### ACCESSORIES TO ORDER AS SEPARATE ITEMS

00BL1000	Lithium battery	1 pc.
----------	-----------------	-------

Suggested for 10-12 room service

#### ON REQUEST, WITH SURCHARGE



wheels with rubber tyres for exterior use ø 200x50 mm

TROLLEY REF.  
**SE0304020KE00**



EMOTION

MORGAN HOTEL ELEGANCE

ALPHA HOTEL

SILVER

TROLLEYS FOR LAUNDRY COLLECTION

## Trolleys with long base

### EMOTION DRIVE 0305020PE - plastic trolley

**NEW**



### EMOTION 0300020 - plastic trolley

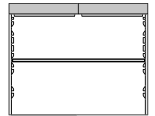

REF.	PCK	VOLUME (m³)	GROSS WEIGHT (kg)	SIZE (cm) ↓ ↓ ↓
<b>SE0305020PE00</b>	1	1,71	80,3	154x64x149,5

0000SM00165	Set of T-shaped light grey closing plugs for vertical frames (6 pcs)	2 pc.
P066481Q	Long base with 2 ø 200x45 mm wheels, 2 bumpers and motor kit	1 pc.
P130001Q	Door stopper made of plastic and rubber	1 pc.
P1908839E	Side-walls blocking device	1 pc.
P1918802E	Big fixed side wall	2 pc.
P1948802E	Small fixed side wall	2 pc.
P2038805E	Big vertical frame, 1 side for T-plugs + 1 side with slides, complete with screws	2 pc.
P2038806E	Small vertical frame, 1 smooth side + 1 side with slides	2 pc.
P2228800Q	Long smooth fixed shelf	1 pc.
P2229911Q	Long pull-out shelf	1 pc.
P2908822Q	Right closing profile for Emotion trolleys with door	1 pc.
P2908823Q	Left closing profile for Emotion trolleys with door	1 pc.
P3228800QU	Long smooth fixed shelf with central tray support	1 pc.
P3229915U	Grey pull-out plastic tray with slide out limiter and removable locking key	2 pc.
P375000Q	Supporting plate with bumpers for Emotion	1 pc.
P3908835Q	Right closing profile with push-grip for Emotion trolleys with door	1 pc.
P3928802E	Big right door with lock and assembling kit	1 pc.
P3938802E	Big left door with assembling kit	1 pc.
P3958802E	Small right door with lock and assembling kit	1 pc.
P3968802E	Small left door with assembling kit	1 pc.
P8268801Q	Left foldable bag holder 120 L with bumpers for Emotion trolleys with door	1 pc.

REF.	PCK	VOLUME (m³)	GROSS WEIGHT (kg)	SIZE (cm) ↓ ↓ ↓
<b>SE0300020AE00</b>	1	0,261	29,43	110x64x103,5

0000SM00165	Set of T-shaped light grey closing plugs for vertical frames (6 pcs)	2 pc.
P130001Q	Door stopper made of plastic and rubber	1 pc.
P166131Q	Long base with 5 rubber wheels ø 125 mm and bumpers ø 200 mm	1 pc.
P1908839E	Side-walls blocking device	1 pc.
P1918802E	Big fixed side wall	2 pc.
P2038805E	Big vertical frame, 1 side for T-plugs + 1 side with slides, complete with screws	2 pc.
P2229911Q	Long pull-out shelf	1 pc.
P3228800QU	Long smooth fixed shelf with central tray support	1 pc.
P3229915U	Grey pull-out plastic tray with slide out limiter and removable locking key	2 pc.
P3908835Q	Right closing profile with push-grip for Emotion trolleys with door	1 pc.
P3908836Q	Left closing profile with push-grip for Emotion trolleys with door	1 pc.
P3928802E	Big right door with lock and assembling kit	1 pc.
P3938802E	Big left door with assembling kit	1 pc.

Suggested for 8 to 10 rooms

### ACCESSORIES TO ORDER AS SEPARATE ITEMS

0000AT0120E	Grey plastic-coated bag 73x97,5 cm, capacity 120 L, with bottom grip	1 pc.
00BL1000	Lithium battery	1 pc.

Suggested for 10-12 room service

### ON REQUEST, WITH SURCHARGE



wheels with rubber tyres for exterior use ø 200x50 mm

TROLLEY REF.  
**SE0305020KE00**

# Housekeeping trolleys



EMOTION

MORGANHOTELELEGANCE

ALPHAHOTEL

SILVER

TROLLEYS FOR LAUNDRY  
COLLECTION

## EMOTION 0301020 - plastic trolley

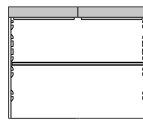

REF.	PCK	VOLUME (m <sup>3</sup> )	GROSS WEIGHT (kg)	SIZE (cm) ↓ ↓ ↓
<b>SE0301020AE00</b>	1	0,372	33,64	154x64x103,5
0000SM00165	Set of T-shaped light grey closing plugs for vertical frames (6 pcs)			2 pc.
P075130Q	Base extension with rubber wheel ø 125 mm			1 pc.
P130001Q	Door stopper made of plastic and rubber			1 pc.
P166131Q	Long base with 5 rubber wheels ø 125 mm and bumpers ø 200 mm			1 pc.
P1908839E	Side-walls blocking device			1 pc.
P1918802E	Big fixed side wall			2 pc.
P2038805E	Big vertical frame, 1 side for T-plugs + 1 side with slides, complete with screws			2 pc.
P2229911Q	Long pull-out shelf			1 pc.
P3228800QU	Long smooth fixed shelf with central tray support			1 pc.
P3229915U	Grey pull-out plastic tray with slide out limiter and removable locking key			2 pc.
P3908835Q	Right closing profile with push-grip for Emotion trolleys with door			1 pc.
P3928802E	Big right door with lock and assembling kit			1 pc.
P3938802E	Big left door with assembling kit			1 pc.
P8268801Q	Left foldable bag holder 120 L with bumpers for Emotion trolleys with door			1 pc.

### ACCESSORIES TO ORDER AS SEPARATE ITEMS

0000AT0120E	Grey plastic-coated bag 73x97,5 cm, capacity 120 L, with bottom grip	1 pc.
-------------	--	-------

Suggested for 8 to 10 rooms

## EMOTION 0301021 - plastic trolley



REF.	PCK	VOLUME (m <sup>3</sup> )	GROSS WEIGHT (kg)	SIZE (cm) ↓ ↓ ↓
<b>SE0301021AE00</b>	1	0,261	29,94	154x64x103,5
0000SM00165	Set of T-shaped light grey closing plugs for vertical frames (6 pcs)			2 pc.
P075130Q	Base extension with rubber wheel ø 125 mm			1 pc.
P130001Q	Door stopper made of plastic and rubber			1 pc.
P166131Q	Long base with 5 rubber wheels ø 125 mm and bumpers ø 200 mm			1 pc.
P1908839E	Side-walls blocking device			1 pc.
P1918802E	Big fixed side wall			2 pc.
P2038805E	Big vertical frame, 1 side for T-plugs + 1 side with slides, complete with screws			2 pc.
P2229911Q	Long pull-out shelf			1 pc.
P3228800QU	Long smooth fixed shelf with central tray support			1 pc.
P3229915U	Grey pull-out plastic tray with slide out limiter and removable locking key			2 pc.
P3908833Q	Right closing profile with push-grip for Emotion trolleys without door			1 pc.
P8268803Q	Left foldable bag holder 120 L with bumpers for Emotion trolleys without door			1 pc.

### ACCESSORIES TO ORDER AS SEPARATE ITEMS

0000AT0120E	Grey plastic-coated bag 73x97,5 cm, capacity 120 L, with bottom grip	1 pc.
-------------	--	-------

Suggested for 8 to 10 rooms



EMOTION

MORGAN HOTEL ELEGANCE

ALPHA HOTEL

SILVER

TROLLEYS FOR LAUNDRY COLLECTION

## EMOTION 0401021 - plastic trolley



## EMOTION 0304020 - plastic trolley



REF.	PCK	VOLUME (m <sup>3</sup> )	GROSS WEIGHT (kg)	SIZE (cm) ↓ ↓ ↓
<b>SE0401021AE00</b>	1	0,372	31,5	154x64x103,5

0000SM00165	Set of T-shaped light grey closing plugs for vertical frames (6 pcs)	2 pc.
P075130Q	Base extension with rubber wheel ø 125 mm	1 pc.
P130001Q	Door stopper made of plastic and rubber	1 pc.
P166131Q	Long base with 5 rubber wheels ø 125 mm and bumpers ø 200 mm	1 pc.
P1918802E	Big fixed side wall	2 pc.
P2038805E	Big vertical frame, 1 side for T-plugs + 1 side with slides, complete with screws	2 pc.
P2229910Q	Small pull-out shelf	2 pc.
P2328801Q	Big fixed shelf with seat for vertical frame	1 pc.
P3038804E	Big vertical frame, 2 sides with slides, complete with screws	1 pc.
P3229915U	Grey pull-out plastic tray with slide out limiter and removable locking key	2 pc.
P3908833Q	Right closing profile with push-grip for Emotion trolleys without door	1 pc.
P8268803Q	Left foldable bag holder 120 L with bumpers for Emotion trolleys without door	1 pc.

### ACCESSORIES TO ORDER AS SEPARATE ITEMS

0000AT0120E	Grey plastic-coated bag 73x97,5 cm, capacity 120 L, with bottom grip	1 pc.
-------------	--	-------

Suggested for 8 to 10 rooms

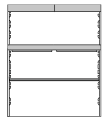

REF.	PCK	VOLUME (m <sup>3</sup> )	GROSS WEIGHT (kg)	SIZE (cm) ↓ ↓ ↓
<b>SE0304020AE00</b>	1	0,372	40,15	110x64x142,5

0000SM00165	Set of T-shaped light grey closing plugs for vertical frames (6 pcs)	2 pc.
P130001Q	Door stopper made of plastic and rubber	1 pc.
P166131Q	Long base with 5 rubber wheels ø 125 mm and bumpers ø 200 mm	1 pc.
P1908839E	Side-walls blocking device	1 pc.
P1918802E	Big fixed side wall	2 pc.
P1948802E	Small fixed side wall	2 pc.
P2038805E	Big vertical frame, 1 side for T-plugs + 1 side with slides, complete with screws	2 pc.
P2038806E	Small vertical frame, 1 smooth side + 1 side with slides	2 pc.
P2228800Q	Long smooth fixed shelf	1 pc.
P2229911Q	Long pull-out shelf	1 pc.
P2908822Q	Right closing profile for Emotion trolleys with door	1 pc.
P2908823Q	Left closing profile for Emotion trolleys with door	1 pc.
P3228800QU	Long smooth fixed shelf with central tray support	1 pc.
P3229915U	Grey pull-out plastic tray with slide out limiter and removable locking key	2 pc.
P3908835Q	Right closing profile with push-grip for Emotion trolleys with door	1 pc.
P3908836Q	Left closing profile with push-grip for Emotion trolleys with door	1 pc.
P3928802E	Big right door with lock and assembling kit	1 pc.
P3938802E	Big left door with assembling kit	1 pc.
P3958802E	Small right door with lock and assembling kit	1 pc.
P3968802E	Small left door with assembling kit	1 pc.

Suggested for 10-12 room service



# Housekeeping trolleys



EMOTION

MORGANHOTELELEGANCE

ALPHAHOTEL

SILVER

TROLLEYS FOR LAUNDRY COLLECTION

## EMOTION 0304004 - plastic trolley



## EMOTION 0404021 - plastic trolley



REF.	PCK	VOLUME (m <sup>3</sup> )	GROSS WEIGHT (kg)	SIZE (cm) ↓ ↓ ↓
<b>SE0304004AE00</b>	1	0,261	33	110x64x142,5
0000SM00165	Set of T-shaped light grey closing plugs for vertical frames (6 pcs)			2 pc.
P130001Q	Door stopper made of plastic and rubber			1 pc.
P166131Q	Long base with 5 rubber wheels ø 125 mm and bumpers ø 200 mm			1 pc.
P2038805E	Big vertical frame, 1 side for T-plugs + 1 side with slides, complete with screws			2 pc.
P2038806E	Small vertical frame, 1 smooth side + 1 side with slides			2 pc.
P2228800Q	Long smooth fixed shelf			1 pc.
P2229911Q	Long pull-out shelf			1 pc.
P2908820Q	Right closing profile for Emotion trolleys without door			1 pc.
P2908821Q	Left closing profile for Emotion trolleys without door			1 pc.
P3228800QU	Long smooth fixed shelf with central tray support			1 pc.
P3229915U	Grey pull-out plastic tray with slide out limiter and removable locking key			2 pc.
P3908833Q	Right closing profile with push-grip for Emotion trolleys without door			1 pc.
P3908834Q	Left closing profile with push-grip for Emotion trolleys without door			1 pc.

Suggested for 10-12 room service

REF.	PCK	VOLUME (m <sup>3</sup> )	GROSS WEIGHT (kg)	SIZE (cm) ↓ ↓ ↓
<b>SE0404021AE00</b>	1	0,372	37,97	110x64x142,5
0000SM00165	Set of T-shaped light grey closing plugs for vertical frames (6 pcs)			2 pc.
P130001Q	Door stopper made of plastic and rubber			1 pc.
P166131Q	Long base with 5 rubber wheels ø 125 mm and bumpers ø 200 mm			1 pc.
P1918802E	Big fixed side wall			2 pc.
P1948802E	Small fixed side wall			2 pc.
P2038805E	Big vertical frame, 1 side for T-plugs + 1 side with slides, complete with screws			2 pc.
P2038806E	Small vertical frame, 1 smooth side + 1 side with slides			2 pc.
P2038807E	Small vertical frame, 2 sides with slides			1 pc.
P2229910Q	Small pull-out shelf			2 pc.
P2328801Q	Big fixed shelf with seat for vertical frame			2 pc.
P2908820Q	Right closing profile for Emotion trolleys without door			1 pc.
P2908821Q	Left closing profile for Emotion trolleys without door			1 pc.
P3038804E	Big vertical frame, 2 sides with slides, complete with screws			1 pc.
P3229915U	Grey pull-out plastic tray with slide out limiter and removable locking key			2 pc.
P3908833Q	Right closing profile with push-grip for Emotion trolleys without door			1 pc.
P3908834Q	Left closing profile with push-grip for Emotion trolleys without door			1 pc.

Suggested for 10-12 room service



EMOTION

MORGAN HOTEL ELEGANCE

ALPHA HOTEL

SILVER

TROLLEYS FOR LAUNDRY COLLECTION

## EMOTION 0305020 - plastic trolley



REF.	PCK	VOLUME (m <sup>3</sup> )	GROSS WEIGHT (kg)	SIZE (cm) ↓ ↓ ↓
<b>SE0305020AE00</b>	1	0,438	40,87	154x64x142,5
0000SM00165	Set of T-shaped light grey closing plugs for vertical frames (6 pcs)			2 pc.
P075130Q	Base extension with rubber wheel ø 125 mm			1 pc.
P130001Q	Door stopper made of plastic and rubber			1 pc.
P166131Q	Long base with 5 rubber wheels ø 125 mm and bumpers ø 200 mm			1 pc.
P1908839E	Side-walls blocking device			1 pc.
P1918802E	Big fixed side wall			2 pc.
P1948802E	Small fixed side wall			2 pc.
P2038805E	Big vertical frame, 1 side for T-plugs + 1 side with slides, complete with screws			2 pc.
P2038806E	Small vertical frame, 1 smooth side + 1 side with slides			2 pc.
P2228800Q	Long smooth fixed shelf			1 pc.
P2229911Q	Long pull-out shelf			1 pc.
P2908822Q	Right closing profile for Emotion trolleys with door			1 pc.
P2908823Q	Left closing profile for Emotion trolleys with door			1 pc.
P3228800QU	Long smooth fixed shelf with central tray support			1 pc.
P3229915U	Grey pull-out plastic tray with slide out limiter and removable locking key			2 pc.
P3908835Q	Right closing profile with push-grip for Emotion trolleys with door			1 pc.
P3928802E	Big right door with lock and assembling kit			1 pc.
P3938802E	Big left door with assembling kit			1 pc.
P3958802E	Small right door with lock and assembling kit			1 pc.
P3968802E	Small left door with assembling kit			1 pc.
P8268801Q	Left foldable bag holder 120 L with bumpers for Emotion trolleys with door			1 pc.

### ACCESSORIES TO ORDER AS SEPARATE ITEMS

0000AT0120E	Grey plastic-coated bag 73x97,5 cm, capacity 120 L, with bottom grip	1 pc.
-------------	--	-------

Suggested for 10-12 room service

## EMOTION 0305021 - plastic trolley



REF.	PCK	VOLUME (m <sup>3</sup> )	GROSS WEIGHT (kg)	SIZE (cm) ↓ ↓ ↓
<b>SE0305021AE00</b>	1	0,372	38,63	154x64x142,5
0000SM00165	Set of T-shaped light grey closing plugs for vertical frames (6 pcs)			2 pc.
P075130Q	Base extension with rubber wheel ø 125 mm			1 pc.
P130001Q	Door stopper made of plastic and rubber			1 pc.
P166131Q	Long base with 5 rubber wheels ø 125 mm and bumpers ø 200 mm			1 pc.
P1908839E	Side-walls blocking device			1 pc.
P1918802E	Big fixed side wall			2 pc.
P1948802E	Small fixed side wall			2 pc.
P2038805E	Big vertical frame, 1 side for T-plugs + 1 side with slides, complete with screws			2 pc.
P2038806E	Small vertical frame, 1 smooth side + 1 side with slides			2 pc.
P2228800Q	Long smooth fixed shelf			1 pc.
P2229911Q	Long pull-out shelf			1 pc.
P2908820Q	Right closing profile for Emotion trolleys without door			1 pc.
P2908821Q	Left closing profile for Emotion trolleys without door			1 pc.
P3228800QU	Long smooth fixed shelf with central tray support			1 pc.
P3229915U	Grey pull-out plastic tray with slide out limiter and removable locking key			2 pc.
P3908833Q	Right closing profile with push-grip for Emotion trolleys without door			1 pc.
P8268803Q	Left foldable bag holder 120 L with bumpers for Emotion trolleys without door			1 pc.

### ACCESSORIES TO ORDER AS SEPARATE ITEMS

0000AT0120E	Grey plastic-coated bag 73x97,5 cm, capacity 120 L, with bottom grip	1 pc.
-------------	--	-------

Suggested for 10-12 room service

# Housekeeping trolleys



EMOTION

MORGAN HOTEL ELEGANCE

ALPHA HOTEL

SILVER

TROLLEYS FOR LAUNDRY COLLECTION

## EMOTION 0505021 - plastic trolley



## EMOTION 0605021 - plastic trolley



REF.	PCK	VOLUME (m³)	GROSS WEIGHT (kg)	SIZE (cm) ↓ ↓ ↓
<b>SE0505021AE06</b>	1	0,438	44,96	154x64x142,5
0000SM00165	Set of T-shaped light grey closing plugs for vertical frames (6 pcs)	2 pc.		
P075130Q	Base extension with rubber wheel ø 125 mm	1 pc.		
P130001Q	Door stopper made of plastic and rubber	1 pc.		
P166131Q	Long base with 5 rubber wheels ø 125 mm and bumpers ø 200 mm	1 pc.		
P1908839E	Side-walls blocking device	1 pc.		
P1918802E	Big fixed side wall	2 pc.		
P1948802E	Small fixed side wall	2 pc.		
P2038805E	Big vertical frame, 1 side for T-plugs + 1 side with slides, complete with screws	2 pc.		
P2038806E	Small vertical frame, 1 smooth side + 1 side with slides	2 pc.		
P2038807E	Small vertical frame, 2 sides with slides	1 pc.		
P2229909U	Plastic sliding drawer 10 L with lock	3 pcs		
P2229910Q	Small pull-out shelf	1 pc.		
P2229911Q	Long pull-out shelf	1 pc.		
P2328801Q	Big fixed shelf with seat for vertical frame	1 pc.		
P2908820Q	Right closing profile for Emotion trolleys without door	1 pc.		
P2908821Q	Left closing profile for Emotion trolleys without door	1 pc.		
P3228801QU	Long fixed shelf with seat for vertical frame and central tray support	1 pc.		
P3229915U	Grey pull-out plastic tray with slide out limiter and removable locking key	2 pc.		
P3908833Q	Right closing profile with push-grip for Emotion trolleys without door	1 pc.		
P8268803Q	Left foldable bag holder 120 L with bumpers for Emotion trolleys without door	1 pc.		

### ACCESSORIES TO ORDER AS SEPARATE ITEMS

0000AT0120E	Grey plastic-coated bag 73x97,5 cm, capacity 120 L, with bottom grip	1 pc.
-------------	--	-------

Suggested for 10-12 room service

REF.	PCK	VOLUME (m³)	GROSS WEIGHT (kg)	SIZE (cm) ↓ ↓ ↓
<b>SE0605021AE00</b>	1	0,372	39,57	154x64x142,5
0000SM00165	Set of T-shaped light grey closing plugs for vertical frames (6 pcs)	2 pc.		
P075130Q	Base extension with rubber wheel ø 125 mm	1 pc.		
P130001Q	Door stopper made of plastic and rubber	1 pc.		
P166131Q	Long base with 5 rubber wheels ø 125 mm and bumpers ø 200 mm	1 pc.		
P1918802E	Big fixed side wall	2 pc.		
P1948802E	Small fixed side wall	2 pc.		
P2038805E	Big vertical frame, 1 side for T-plugs + 1 side with slides, complete with screws	2 pc.		
P2038806E	Small vertical frame, 1 smooth side + 1 side with slides	2 pc.		
P2228800Q	Long smooth fixed shelf	1 pc.		
P2229910Q	Small pull-out shelf	2 pc.		
P2328801Q	Big fixed shelf with seat for vertical frame	1 pc.		
P2908820Q	Right closing profile for Emotion trolleys without door	1 pc.		
P2908821Q	Left closing profile for Emotion trolleys without door	1 pc.		
P3038804E	Big vertical frame, 2 sides with slides, complete with screws	1 pc.		
P3229915U	Grey pull-out plastic tray with slide out limiter and removable locking key	2 pc.		
P3908833Q	Right closing profile with push-grip for Emotion trolleys without door	1 pc.		
P8268803Q	Left foldable bag holder 120 L with bumpers for Emotion trolleys without door	1 pc.		

### ACCESSORIES TO ORDER AS SEPARATE ITEMS

0000AT0120E	Grey plastic-coated bag 73x97,5 cm, capacity 120 L, with bottom grip	1 pc.
-------------	--	-------

Suggested for 10-12 room service



EMOTION

MORGAN HOTEL ELEGANCE

ALPHA HOTEL

SILVER

TROLLEYS FOR LAUNDRY COLLECTION

## EMOTION 0306020 - plastic trolley



REF.	PCK	VOLUME (m <sup>3</sup> )	GROSS WEIGHT (kg)	SIZE (cm) ↓ ↓ ↓
<b>SE0306020AE00</b>	1	0,468	49,29	197x64x142,5
0000SM00165	Set of T-shaped light grey closing plugs for vertical frames (6 pcs)			2 pc.
P075130Q	Base extension with rubber wheel ø 125 mm			2 pc.
P130001Q	Door stopper made of plastic and rubber			1 pc.
P166131Q	Long base with 5 rubber wheels ø 125 mm and bumpers ø 200 mm			1 pc.
P1908839E	Side-walls blocking device			1 pc.
P1918802E	Big fixed side wall			2 pc.
P1948802E	Small fixed side wall			2 pc.
P2038805E	Big vertical frame, 1 side for T-plugs + 1 side with slides, complete with screws			2 pc.
P2038806E	Small vertical frame, 1 smooth side + 1 side with slides			2 pc.
P2228800Q	Long smooth fixed shelf			1 pc.
P2229911Q	Long pull-out shelf			1 pc.
P2908822Q	Right closing profile for Emotion trolleys with door			1 pc.
P2908823Q	Left closing profile for Emotion trolleys with door			1 pc.
P3228800QU	Long smooth fixed shelf with central tray support			1 pc.
P3229915U	Grey pull-out plastic tray with slide out limiter and removable locking key			2 pc.
P3928802E	Big right door with lock and assembling kit			1 pc.
P3938802E	Big left door with assembling kit			1 pc.
P3958802E	Small right door with lock and assembling kit			1 pc.
P3968802E	Small left door with assembling kit			1 pc.
P8268800Q	Right foldable bag holder 120 L with bumpers for Emotion trolleys with door			1 pc.
P8268801Q	Left foldable bag holder 120 L with bumpers for Emotion trolleys with door			1 pc.

### ACCESSORIES TO ORDER AS SEPARATE ITEMS

0000AT0120E	Grey plastic-coated bag 73x97,5 cm, capacity 120 L, with bottom grip	2 pc.
-------------	--	-------

Suggested for 10-12 room service

## EMOTION 0306021 - plastic trolley



REF.	PCK	VOLUME (m <sup>3</sup> )	GROSS WEIGHT (kg)	SIZE (cm) ↓ ↓ ↓
<b>SE0306021AE00</b>	1	0,372	42,87	197x64x142,5
0000SM00165	Set of T-shaped light grey closing plugs for vertical frames (6 pcs)			2 pc.
P075130Q	Base extension with rubber wheel ø 125 mm			2 pc.
P130001Q	Door stopper made of plastic and rubber			1 pc.
P166131Q	Long base with 5 rubber wheels ø 125 mm and bumpers ø 200 mm			1 pc.
P1908839E	Side-walls blocking device			1 pc.
P1918802E	Big fixed side wall			2 pc.
P1948802E	Small fixed side wall			2 pc.
P2038805E	Big vertical frame, 1 side for T-plugs + 1 side with slides, complete with screws			2 pc.
P2038806E	Small vertical frame, 1 smooth side + 1 side with slides			2 pc.
P2228800Q	Long smooth fixed shelf			1 pc.
P2229911Q	Long pull-out shelf			1 pc.
P2908820Q	Right closing profile for Emotion trolleys without door			1 pc.
P2908821Q	Left closing profile for Emotion trolleys without door			1 pc.
P3228800QU	Long smooth fixed shelf with central tray support			1 pc.
P3229915U	Grey pull-out plastic tray with slide out limiter and removable locking key			2 pc.
P8268802Q	Right foldable bag holder 120 L with bumpers for Emotion trolleys without door			1 pc.
P8268803Q	Left foldable bag holder 120 L with bumpers for Emotion trolleys without door			1 pc.

### ACCESSORIES TO ORDER AS SEPARATE ITEMS

0000AT0120E	Grey plastic-coated bag 73x97,5 cm, capacity 120 L, with bottom grip	2 pc.
-------------	--	-------

Suggested for 10-12 room service

# Housekeeping trolleys



EMOTION

MORGAN HOTEL ELEGANCE

ALPHA HOTEL

SILVER

TROLLEYS FOR LAUNDRY COLLECTION

## EMOTION 0506021 - plastic trolley



## EMOTION 0317020 - plastic trolley



REF.	PCK	VOLUME (m <sup>3</sup> )	GROSS WEIGHT (kg)	SIZE (cm) ↓ ↓ ↓
<b>SE0506021AE00</b>	1	0,372	44,47	197x64x142,5

0000SM00165	Set of T-shaped light grey closing plugs for vertical frames (6 pcs)	2 pc.
P075130Q	Base extension with rubber wheel ø 125 mm	2 pc.
P130001Q	Door stopper made of plastic and rubber	1 pc.
P166131Q	Long base with 5 rubber wheels ø 125 mm and bumpers ø 200 mm	1 pc.
P1908839E	Side-walls blocking device	1 pc.
P1918802E	Big fixed side wall	2 pc.
P1948802E	Small fixed side wall	2 pc.
P2038805E	Big vertical frame, 1 side for T-plugs + 1 side with slides, complete with screws	2 pc.
P2038806E	Small vertical frame, 1 smooth side + 1 side with slides	2 pc.
P2038807E	Small vertical frame, 2 sides with slides	1 pc.
P2229911Q	Long pull-out shelf	1 pc.
P2328801Q	Big fixed shelf with seat for vertical frame	1 pc.
P2908820Q	Right closing profile for Emotion trolleys without door	1 pc.
P2908821Q	Left closing profile for Emotion trolleys without door	1 pc.
P3228801QU	Long fixed shelf with seat for vertical frame and central tray support	1 pc.
P3229915U	Grey pull-out plastic tray with slide out limiter and removable locking key	2 pc.
P8268802Q	Right foldable bag holder 120 L with bumpers for Emotion trolleys without door	1 pc.
P8268803Q	Left foldable bag holder 120 L with bumpers for Emotion trolleys without door	1 pc.

### ACCESSORIES TO ORDER AS SEPARATE ITEMS

0000AT0120E	Grey plastic-coated bag 73x97,5 cm, capacity 120 L, with bottom grip	2 pc.
-------------	--	-------

Suggested for 10-12 room service

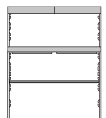

REF.	PCK	VOLUME (m <sup>3</sup> )	GROSS WEIGHT (kg)	SIZE (cm) ↓ ↓ ↓
<b>SE0317020AE00</b>	1	0,438	50,46	175x64x142,5

0000SM00165	Set of T-shaped light grey closing plugs for vertical frames (6 pcs)	2 pc.
P075130Q	Base extension with rubber wheel ø 125 mm	2 pc.
P130001Q	Door stopper made of plastic and rubber	1 pc.
P166131Q	Long base with 5 rubber wheels ø 125 mm and bumpers ø 200 mm	1 pc.
P1908839E	Side-walls blocking device	1 pc.
P1918802E	Big fixed side wall	2 pc.
P1948802E	Small fixed side wall	2 pc.
P2038805E	Big vertical frame, 1 side for T-plugs + 1 side with slides, complete with screws	2 pc.
P2038806E	Small vertical frame, 1 smooth side + 1 side with slides	2 pc.
P2228800Q	Long smooth fixed shelf	1 pc.
P2229911Q	Long pull-out shelf	1 pc.
P2908822Q	Right closing profile for Emotion trolleys with door	2 pc.
P2908823Q	Left closing profile for Emotion trolleys with door	1 pc.
P3228800QU	Long smooth fixed shelf with central tray support	1 pc.
P3229915U	Grey pull-out plastic tray with slide out limiter and removable locking key	2 pc.
P3928802E	Big right door with lock and assembling kit	1 pc.
P3938802E	Big left door with assembling kit	1 pc.
P3958802E	Small right door with lock and assembling kit	1 pc.
P3968802E	Small left door with assembling kit	1 pc.
P8268801Q	Left foldable bag holder 120 L with bumpers for Emotion trolleys with door	1 pc.
R2180085	Rilsan coated support for vacuum cleaner that can be assembled to the vertical frame of the Emotion trolleys	1 pc.

### ACCESSORIES TO ORDER AS SEPARATE ITEMS

0000AT0120E	Grey plastic-coated bag 73x97,5 cm, capacity 120 L, with bottom grip	1 pc.
-------------	--	-------

Suggested for 10-12 room service



EMOTION

MORGAN HOTEL ELEGANCE

ALPHA HOTEL

SILVER

TROLLEYS FOR LAUNDRY COLLECTION

## EMOTION 0318021 - plastic trolley



## EMOTION 0316020 - plastic trolley



REF.	PCK	VOLUME (m <sup>3</sup> )	GROSS WEIGHT (kg)	SIZE (cm) ↓ ↓ ↓
<b>SE0318021AE00</b>	1	0,438	50,26	175x64x142,5

0000SM00165	Set of T-shaped light grey closing plugs for vertical frames (6 pcs)	2 pc.
P075130Q	Base extension with rubber wheel ø 125 mm	2 pc.
P130001Q	Door stopper made of plastic and rubber	1 pc.
P166131Q	Long base with 5 rubber wheels ø 125 mm and bumpers ø 200 mm	1 pc.
P1908839E	Side-walls blocking device	1 pc.
P1918802E	Big fixed side wall	2 pc.
P1948802E	Small fixed side wall	2 pc.
P2038805E	Big vertical frame, 1 side for T-plugs + 1 side with slides, complete with screws	2 pc.
P2038806E	Small vertical frame, 1 smooth side + 1 side with slides	2 pc.
P2228800Q	Long smooth fixed shelf	1 pc.
P2229911Q	Long pull-out shelf	1 pc.
P2908820Q	Right closing profile for Emotion trolleys without door	2 pc.
P2908821Q	Left closing profile for Emotion trolleys without door	1 pc.
P3228800QU	Long smooth fixed shelf with central tray support	1 pc.
P3229915U	Grey pull-out plastic tray with slide out limiter and removable locking key	2 pc.
P8268803Q	Left foldable bag holder 120 L with bumpers for Emotion trolleys without door	1 pc.
Q1400123E	Emotion trolley bathrobe and/or towel holder kit for Emotion trolleys	1 pc.

### ACCESSORIES TO ORDER AS SEPARATE ITEMS

0000AT0120E	Grey plastic-coated bag 73x97,5 cm, capacity 120 L, with bottom grip	1 pc.
-------------	--	-------

Suggested for 10-12 room service

REF.	PCK	VOLUME (m <sup>3</sup> )	GROSS WEIGHT (kg)	SIZE (cm) ↓ ↓ ↓
<b>SE0316020AE00</b>	1	0,438	48	138x64x142,5

REF.	PCK	VOLUME (m <sup>3</sup> )	GROSS WEIGHT (kg)	SIZE (cm) ↓ ↓ ↓
<b>SE0316020AE00</b>	1	0,438	48	138x64x142,5

0000SE1222U	Plastic bucket 20L with plastic handle, grey	1 pc.
0000SE1322U	TOP-DOWN - plastic bucket with plastic handle and watertight lid, 20 l, grey	1 pc.
0000SM00165	Set of T-shaped light grey closing plugs for vertical frames (6 pcs)	2 pc.
P130001Q	Door stopper made of plastic and rubber	1 pc.
P165000U	Base extension for Alpha trolleys and for the bag supporting plastic plate of the Morgan Hotel Elegance trolleys	2 pc.
P166131Q	Long base with 5 rubber wheels ø 125 mm and bumpers ø 200 mm	1 pc.
P1908839E	Side-walls blocking device	1 pc.
P1918802E	Big fixed side wall	2 pc.
P1948802E	Small fixed side wall	2 pc.
P2038805E	Big vertical frame, 1 side for T-plugs + 1 side with slides, complete with screws	2 pc.
P2038806E	Small vertical frame, 1 smooth side + 1 side with slides	2 pc.
P2228800Q	Long smooth fixed shelf	1 pc.
P2229911Q	Long pull-out shelf	1 pc.
P2908822Q	Right closing profile for Emotion trolleys with door	1 pc.
P2908823Q	Left closing profile for Emotion trolleys with door	1 pc.
P3228800QU	Long smooth fixed shelf with central tray support	1 pc.
P3229915U	Grey pull-out plastic tray with slide out limiter and removable locking key	2 pc.
P3908835Q	Right closing profile with push-grip for Emotion trolleys with door	1 pc.
P3908836Q	Left closing profile with push-grip for Emotion trolleys with door	1 pc.
P3928802E	Big right door with lock and assembling kit	1 pc.
P3938802E	Big left door with assembling kit	1 pc.
P3958802E	Small right door with lock and assembling kit	1 pc.
P3968802E	Small left door with assembling kit	1 pc.

Suggested for 10-12 room service



EMOTION

MORGAN HOTEL ELEGANCE

ALPHA HOTEL

SILVER

TROLLEYS FOR LAUNDRY COLLECTION

## Trolleys with short base

### EMOTION 0105020 - plastic trolley



REF.	PCK	VOLUME (m <sup>3</sup> )	GROSS WEIGHT (kg)	SIZE (cm) ↓ ↓ ↓
<b>SE0105020AE00</b>	1	0,372	31,85	110x64x142,5
0000SM00165	Set of T-shaped light grey closing plugs for vertical frames (6 pcs)			2 pc.
P1228802Q	Small fixed shelf (female-female version)			2 pc.
P130001Q	Door stopper made of plastic and rubber			1 pc.
P159131Q	Short base with 5 rubber wheels ø 125 mm and bumpers ø 200 mm			1 pc.
P165000Q	Supporting plate fitting the base of Emotion trolleys			1 pc.
P1918802E	Big fixed side wall			1 pc.
P1948802E	Small fixed side wall			1 pc.
P2038805E	Big vertical frame, 1 side for T-plugs + 1 side with slides, complete with screws			2 pc.
P2038806E	Small vertical frame, 1 smooth side + 1 side with slides			2 pc.
P2229910Q	Small pull-out shelf			1 pc.
P2908821Q	Left closing profile for Emotion trolleys without door			1 pc.
P2908822Q	Right closing profile for Emotion trolleys with door			1 pc.
P3229915U	Grey pull-out plastic tray with slide out limiter and removable locking key			1 pc.
P3908835Q	Right closing profile with push-grip for Emotion trolleys with door			1 pc.
P3928802E	Big right door with lock and assembling kit			1 pc.
P3958802E	Small right door with lock and assembling kit			1 pc.
P8268803Q	Left foldable bag holder 120 L with bumpers for Emotion trolleys without door			1 pc.

### ACCESSORIES TO ORDER AS SEPARATE ITEMS

0000AT0120E	Grey plastic-coated bag 73x97,5 cm, capacity 120 L, with bottom grip	1 pc.
-------------	--	-------

Suggested for 6 to 8 rooms

### EMOTION 0105021 - plastic trolley



REF.	PCK	VOLUME (m <sup>3</sup> )	GROSS WEIGHT (kg)	SIZE (cm) ↓ ↓ ↓
<b>SE0105021AE00</b>	1	0,261	28,6	110x64x142,5
0000SM00165	Set of T-shaped light grey closing plugs for vertical frames (6 pcs)			2 pc.
P1228802Q	Small fixed shelf (female-female version)			2 pc.
P130001Q	Door stopper made of plastic and rubber			1 pc.
P159131Q	Short base with 5 rubber wheels ø 125 mm and bumpers ø 200 mm			1 pc.
P165000Q	Supporting plate fitting the base of Emotion trolleys			1 pc.
P1918802E	Big fixed side wall			1 pc.
P1948802E	Small fixed side wall			1 pc.
P2038805E	Big vertical frame, 1 side for T-plugs + 1 side with slides, complete with screws			2 pc.
P2038806E	Small vertical frame, 1 smooth side + 1 side with slides			2 pc.
P2229910Q	Small pull-out shelf			1 pc.
P2908820Q	Right closing profile for Emotion trolleys without door			1 pc.
P2908821Q	Left closing profile for Emotion trolleys without door			1 pc.
P3229915U	Grey pull-out plastic tray with slide out limiter and removable locking key			1 pc.
P3908833Q	Right closing profile with push-grip for Emotion trolleys without door			1 pc.
P8268803Q	Left foldable bag holder 120 L with bumpers for Emotion trolleys without door			1 pc.

### ACCESSORIES TO ORDER AS SEPARATE ITEMS

0000AT0120E	Grey plastic-coated bag 73x97,5 cm, capacity 120 L, with bottom grip	1 pc.
-------------	--	-------

Suggested for 6 to 8 rooms



EMOTION

MORGAN HOTEL ELEGANCE

ALPHA HOTEL

SILVER

TROLLEYS FOR LAUNDRY COLLECTION

## EMOTION 0106020 - plastic trolley



## EMOTION 0000020 - plastic trolley

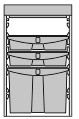

REF.	PCK	VOLUME (m <sup>3</sup> )	GROSS WEIGHT (kg)	SIZE (cm)	
<b>SE0106020AE00</b>	1	0,372	35,44	159x64x142,5	
0000SM00165	Set of T-shaped light grey closing plugs for vertical frames (6 pcs)	2 pc.			
P075130Q	Base extension with rubber wheel ø 125 mm	1 pc.			
P1228802Q	Small fixed shelf (female-female version)	2 pc.			
P130001Q	Door stopper made of plastic and rubber	1 pc.			
P159131Q	Short base with 5 rubber wheels ø 125 mm and bumpers ø 200 mm	1 pc.			
P165000Q	Supporting plate fitting the base of Emotion trolleys	1 pc.			
P1918802E	Big fixed side wall	1 pc.			
P1948802E	Small fixed side wall	1 pc.			
P2038805E	Big vertical frame, 1 side for T-plugs + 1 side with slides, complete with screws	2 pc.			
P2038806E	Small vertical frame, 1 smooth side + 1 side with slides	2 pc.			
P2229910Q	Small pull-out shelf	1 pc.			
P2908821Q	Left closing profile for Emotion trolleys without door	1 pc.			
P2908822Q	Right closing profile for Emotion trolleys with door	1 pc.			
P3229915U	Grey pull-out plastic tray with slide out limiter and removable locking key	1 pc.			
P3928802E	Big right door with lock and assembling kit	1 pc.			
P3958802E	Small right door with lock and assembling kit	1 pc.			
P8268800Q	Right foldable bag holder 120 L with bumpers for Emotion trolleys with door	1 pc.			
P8268803Q	Left foldable bag holder 120 L with bumpers for Emotion trolleys without door	1 pc.			

REF.	PCK	VOLUME (m <sup>3</sup> )	GROSS WEIGHT (kg)	SIZE (cm)	
<b>SE0000020AE01</b>	1	0,27	27,47	65x64x103,5	
0000SM00165	Set of T-shaped light grey closing plugs for vertical frames (6 pcs)	2 pc.			
P025131Q	Compact base with 4 wheels ø 125 mm and bumpers ø 200	1 pc.			
P1228802Q	Small fixed shelf (female-female version)	1 pc.			
P1229907U	Grey plastic sliding drawer 40 L without locking key	1 pc.			
P1229909U	Plastic sliding drawer 10 L without locking key	2 pc.			
P130001Q	Door stopper made of plastic and rubber	1 pc.			
P1918802E	Big fixed side wall	1 pc.			
P2038805E	Big vertical frame, 1 side for T-plugs + 1 side with slides, complete with screws	2 pc.			
P2908821Q	Left closing profile for Emotion trolleys without door	1 pc.			
P3908835Q	Right closing profile with push-grip for Emotion trolleys with door	1 pc.			
P3928802E	Big right door with lock and assembling kit	1 pc.			

Suggested for the mini bar refilling

## ACCESSORIES TO ORDER AS SEPARATE ITEMS

0000AT0120E	Grey plastic-coated bag 73x97,5 cm, capacity 120 L, with bottom grip	2 pc.
-------------	--	-------

Suggested for 6 to 8 rooms



# Housekeeping trolleys



EMOTION

MORGAN HOTELELEGANCE

ALPHAHOTEL

SILVER

TROLLEYS FOR LAUNDRY  
COLLECTION

## EMOTION 0104020 - plastic trolley



REF.	PCK	VOLUME (m <sup>3</sup> )	GROSS WEIGHT (kg)	SIZE (cm) ↓ ↓ ↓
<b>SE0104020AE01</b>	1	0,372	31,67	81x64x142,5
0000SM00165	Set of T-shaped light grey closing plugs for vertical frames (6 pcs)			2 pc.
P1228802Q	Small fixed shelf (female-female version)			2 pc.
P1229907U	Grey plastic sliding drawer 40 L without locking key			1 pc.
P1229909U	Plastic sliding drawer 10 L without locking key			2 pc.
P130001Q	Door stopper made of plastic and rubber			1 pc.
P159131Q	Short base with 5 rubber wheels ø 125 mm and bumpers ø 200 mm			1 pc.
P1918802E	Big fixed side wall			1 pc.
P1948802E	Small fixed side wall			1 pc.
P2038805E	Big vertical frame, 1 side for T-plugs + 1 side with slides, complete with screws			2 pc.
P2038806E	Small vertical frame, 1 smooth side + 1 side with slides			2 pc.
P2229910Q	Small pull-out shelf			1 pc.
P2908821Q	Left closing profile for Emotion trolleys without door			2 pc.
P2908822Q	Right closing profile for Emotion trolleys with door			1 pc.
P3908835Q	Right closing profile with push-grip for Emotion trolleys with door			1 pc.
P3928802E	Big right door with lock and assembling kit			1 pc.
P3958802E	Small right door with lock and assembling kit			1 pc.

Suggested for the mini bar refilling



EMOTION

MORGAN HOTEL ELEGANCE

ALPHA HOTEL

SILVER

TROLLEYS FOR LAUNDRY COLLECTION

## Components and accessories for Emotion trolleys

### Short base with 5 wheels without bumpers



REF.	NOTES
P159061Q	with wheels ø 125 mm
P159081Q	with 125mm ø castors, 2 lockable

### Short base with 5 wheels and bumpers ø 200 mm



REF.	NOTES
P159131Q	with rubber wheels ø 125 mm
P159141Q	with rubber wheels ø 125 mm, 2 with brake
P159261Q	with wheels ø 125 mm with tread 35 mm

### Long base with 5 wheels without bumpers



REF.	NOTES
P166061Q	with wheels ø 125 mm
P166081Q	with wheels ø 125 mm, 2 with brake

### Long base with 5 wheels and bumpers ø 200 mm



REF.	NOTES
P166131Q	with rubber wheels ø 125 mm
P166141Q	with rubber wheels ø 125 mm, 2 with brake
P166261Q	with wheels ø 125 mm with tread 35 mm

### Long base with 4 wheels without bumpers



REF.	NOTES
P066251Q	with rubber wheels ø 150 mm (2 fixed + 2 pirouetting)
P066231Q	with rubber wheels ø 200 mm (2 fixed + 2 pirouetting)
P066281Q	with wheels ø 200 mm (2 fixed + 2 pirouetting)

### Supporting plastic plate with 2 wheels



REF.	NOTES
P515060Q	with wheels ø 125 mm without bumpers
P515130Q	with rubber wheels ø 125 mm and bumpers ø 200 mm

# Housekeeping trolleys



**EMOTION**

MORGAN HOTELELEGANCE

ALPHAHOTEL

SILVER

TROLLEYS FOR LAUNDRY COLLECTION

## Supporting plastic plate with 1 wheel



REF.	NOTES
<b>P075130Q</b>	with rubber wheel ø 125 mm
<b>P075060Q</b>	with wheel ø 125 mm

## Base extension for Emotion trolleys



REF.	NOTES	SIZE (cm) ↓ ↓ ↓
<b>P175000Q</b>		48x32x7

## Supporting plate fitting the base of Emotion trolleys



REF.	NOTES	SIZE (cm) ↓ ↓ ↓
<b>P165000Q</b>		48x22x15

## Big vertical frame, 1 side for T-plugs + 1 side with slides, complete with screws



REF.	NOTES
<b>P2038805E</b>	

## Big vertical frame, 2 sides with slides, complete with screws



REF.	NOTES
<b>P3038804E</b>	

## Small vertical frame, 1 smooth side + 1 side with slides



REF.	NOTES
<b>P2038806E</b>	



EMOTION

MORGAN HOTELELEGANCE

ALPHAHOTEL

SILVER

TROLLEYS FOR LAUNDRY COLLECTION

Small vertical frame, 2 sides with slides



REF.	NOTES
P2038807E	

Small vertical frame, 1 side with slides + 1 side for T-plugs



REF.	NOTES
P2038808E	

Set of T-shaped closing plugs for vertical frames (6 pcs)



REF.	NOTES
0000SM00163	dark grey
0000SM00165	light grey

Small fixed side wall



REF.	NOTES
P1948802E	

Big fixed side wall



REF.	NOTES
P1918802E	

Side-walls blocking device

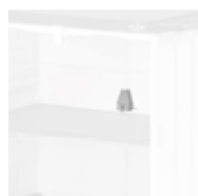

REF.	NOTES
P1908839E	

# Housekeeping trolleys



**EMOTION**

MORGAN HOTELELEGANCE

ALPHAHOTEL

SILVER

TROLLEYS FOR LAUNDRY COLLECTION

Big right door with lock and assembling kit



REF.	NOTES
P3928802E	

Big left door with assembling kit



REF.	NOTES
P3938802E	

Small right door with lock and assembling kit



REF.	NOTES
P3958802E	

Small left door with assembling kit



REF.	NOTES
P3968802E	

Long smooth fixed shelf



REF.	NOTES
P2228800Q	

Long smooth fixed shelf with central tray support



REF.	NOTES
P3228800QU	



EMOTION

MORGAN HOTELELEGANCE

ALPHAHOTEL

SILVER

TROLLEYS FOR LAUNDRY COLLECTION

## Big fixed shelf with seat for vertical frame

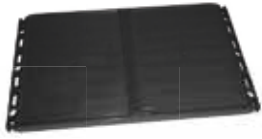

REF.	NOTES
P2328801Q	

## Long fixed shelf with seat for vertical frame and central tray support



REF.	NOTES
P3228801QU	

## Small fixed shelf (female-female version)

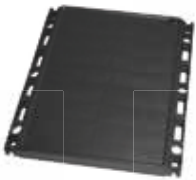

REF.	NOTES
P1228802Q	

## Small fixed shelf (male-female version)

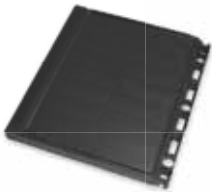

REF.	NOTES
P2228803Q	

## Closing profile



REF.	NOTES
P2908820Q	right for Emotion trolley without door
P2908821Q	left for Emotion trolleys without door
P2908822Q	right for Emotion trolleys with door
P2908823Q	left for Emotion trolleys with door

## Closing profile with push-grip



REF.	NOTES
P3908833Q	right for Emotion trolley without door
P3908834Q	left for Emotion trolleys without door
P3908835Q	right for Emotion trolleys with door
P3908836Q	left for Emotion trolleys with door

## Foldable bag holder 120 L with bumpers



REF.	NOTES
P8268802Q	right for Emotion trolley without door
P8268803Q	left for Emotion trolleys without door
P8268800Q	right for Emotion trolleys with door
P8268801Q	left for Emotion trolleys with door

# Housekeeping trolleys



**EMOTION**

MORGAN HOTEL ELEGANCE

ALPHA HOTEL

SILVER

TROLLEYS FOR LAUNDRY COLLECTION

## Foldable bag holder 120 L without bumpers



REF.	NOTES
P8168802Q	right for Emotion trolley without door
P8168803Q	left for Emotion trolleys without door
P8168800Q	right for Emotion trolleys with door
P8168801Q	left for Emotion trolleys with door

## Bumper set for 120-litre bag holder (no. 1 right bumper + no. 1 left bumper)



REF.	NOTES
0000SM00260	

## Divider for plastic bag holder 120 L



REF.	NOTES
P206020U	2x60 L
P206030U	1x40 L + 1x80 L
P206040U	3x40 L

## Plastic divider with square shaped insert for bag holder 120 L



REF.	NOTES
P306020U	2x60 L and 20 L square shaped insert
P406020U	2x60 L and two 20 L square shaped inserts

For Alpha, Emotion range bag holders and bag holder code P906010U, Morgan range

## Square plastic support 20 L for the divider of bag holder 120 L



REF.	NOTES
P1909957U	

For Alpha, Emotion range bag holders and bag holder code P906010U, Morgan range - Use recommended with net bags, code 0000AT0210

## Plastic cover for bag holder 120 L with check-list holder



REF.	NOTES
P291919A	
P291919B	
P291919T	



Please, require also no. 2 shock absorbing pistons art. P190908U for a perfect soft closing



**EMOTION** | MORGANHOTELELEGANCE | ALPHAHOTEL | SILVER | TROLLEYS FOR LAUNDRY COLLECTION

Plastic cover for bag holder 120 L with storage room, check-list holder and lock

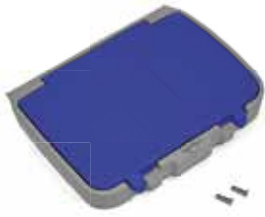

REF.	NOTES
P291920UA	
P291920UB	
P291920U	



Please, require also no. 2 shock absorbing pistons art. P190908U for a perfect soft closing

Tablet holder for mounting on Emotion vertical frame **NEW**



REF.	NOTES
0000SM00402	

Plastified bag with bottom grip



REF.	NOTES	CAPACITY (L)	SIZE (cm)
0000AT0120E		120	73x97

Small pull-out shelf



REF.	NOTES	SIZE (cm)
P2229910Q		46,5x37,5

Long pull-out shelf



REF.	NOTES	SIZE (cm)
P2229911Q		46,5x79

Plastic sliding tray with slide out limiter and key



REF.	NOTES
P3229915U	



# Housekeeping trolleys



EMOTION

MORGAN HOTELELEGANCE

ALPHAHOTEL

SILVER

TROLLEYS FOR LAUNDRY COLLECTION

## Plastic sliding drawer without locking key







REF.	NOTES	CAPACITY (L)	SIZE (cm) ↓ ↓ ↓
P1229909U	internal dimensions 41x34x9,5 cm	10	46,5x37,5x11
P1229906U	internal dimensions 40,5x34x16 cm	22	46,5x37,5x17
P1229907U	internal dimensions 40x34x33,5 cm	40	46,5x37,5x35



## Plastic sliding drawer with locking key



REF.	NOTES	CAPACITY (L)	SIZE (cm) ↓ ↓ ↓
P2229909U	internal dimensions 41x34x9,5 cm 	10	46,5x37,5x11
P2229906A	internal dimensions 40,5x34x16 cm 	22	46,5x37,5x17
P2229906B	internal dimensions 40,5x34x16 cm 	22	46,5x37,5x17
P2229906U	internal dimensions 40,5x34x16 cm 	22	46,5x37,5x17
P2229907U	internal dimensions 40x34x33,5 cm 	40	46,5x37,5x35



## Plastic divider for drawer 10 L



REF.	NOTES
0000SM00227D	9 compartments
0000SM00228D	12 compartments

## Set of 1 big divider 39 cm + 1 medium divider 32 cm for plastic sliding drawer 22 L

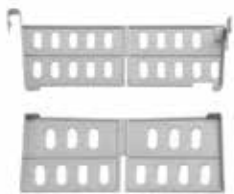

REF.	NOTES
0000SM00213U	

## Set of 1 big divider 39 cm + 3 small dividers 16 cm for plastic sliding drawer 22 L

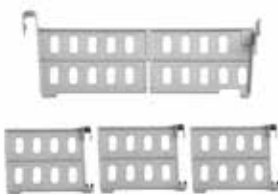

REF.	NOTES
0000SM00214U	



**EMOTION**

MORGAN HOTEL ELEGANCE

ALPHA HOTEL

SILVER

TROLLEYS FOR LAUNDRY COLLECTION

Rilsan coated support for upright vacuum cleaner fitting vertical frames



REF.	NOTES
<b>R2180085</b>	

Bathrobe and/or towel holder kit



REF.	NOTES
<b>Q1400123E</b>	

Recommended with bag supporting plastic plate

Laundry collection trolley with bag 200 L with zip and closure



REF.	NOTES	PCK	VOLUME (m <sup>3</sup> )	GROSS WEIGHT (kg)
<b>0000HP3110Q5</b>		1	0,244	13,76

Rilsan coated coupling device to connect the Emotion trolley to a laundry trolley



REF.	NOTES
<b>R1180080</b>	

Side plastic basket



REF.	NOTES
<b>P1191100U</b>	external dimension 49x22x11,5 cm

Plastic pocket bags to attach to the vertical frames



REF.	NOTES
<b>Q0400073Q</b>	

**NEW**

# Housekeeping trolleys



**EMOTION**

MORGAN HOTELELEGANCE

ALPHAHOTEL

SILVER

TROLLEYS FOR LAUNDRY COLLECTION

Grey waste collection bin 10 L with handle



REF.	NOTES	CAPACITY (L)	SIZE (cm) ↓ ↓ ↓
8168/1U		10	21x13,5x36

UNILAV SIDE GRIP - flat mop with 650ml bottle and holder with Velcro strips



REF.	NOTES
0000TD0151A	with plate 40 cm
0000TD0151U	with plate 40 cm
0000TD0161A	with plate 60 cm

Lithium battery for Drive trolleys



REF.	NOTES
00BL1000	



EMOTION

**MORGAN HOTEL ELEGANCE**

ALPHAHOTEL

SILVER

TROLLEYS FOR LAUNDRY COLLECTION



The **Morgan Hotel Elegance** line is elegant, smart, simple and fits any environment, satisfying any cleaning need and request in hotels.

Characterized by Rilsan coated vertical frames, rich and elegant wooden shelves made of beech, brown plastified panels, easy to remove and periodically clean.

The trolley can be equipped with a wide and complete range of accessories ideal to meet any cleaning need: it can be used for the change of towels and linen, for the collection of dirty towels and linen by means of the specific trolleys for laundry collection, for the cleaning of rooms and bathrooms and for waste collection.

## **NEW** New Light range

**Light range** service trolleys feature a modern design, and are light and easy to control.

The whole range also offers utmost capacity.



### Some details about the Morgan Hotel Elegance line:



Plastic sliding drawer 10 and 22 L with locking key for guest amenities



Handy plastic baskets



Bins and bagholder for the separate waste collection



Bathrobe holder kit



It is standard equipped with the useful door stopper (cod. P130001Q).

### Morgan Hotel Trolleys can be used with several wet mopping systems:



Top-Down® system



Bucket 22 L and its special mop



Master Lux bucket



Unilav wet mopping system

### Accessories



Roll-up front covering: handy and safe



Coupling device to connect the laundry trolley with dirty linen to the Morgan Hotel trolley

# Housekeeping trolleys



EMOTION

**MORGAN HOTEL ELEGANCE**

ALPHAHOTEL

SILVER

TROLLEYS FOR LAUNDRY COLLECTION

## Light series

**MORGAN HOTEL LIGHT 4374** - trolley with wooden shelves

**NEW**



**MORGAN HOTEL LIGHT 4373** - trolley with wooden shelves

**NEW**



REF.	PCK	VOLUME (m <sup>3</sup> )	GROSS WEIGHT (kg)	SIZE (cm) ↓ ↓ ↓
<b>0000HP4374U</b>	1	0,342	41,66	165x55x130
0000AT0185E	90l self-standing Velcro bag, grey			2 pc.
I1900050	Galvanized steel rod 102 cm to fix the back panel			1 pc.
L0220013	Wooden shelf 85, 5x46 cm, for line 800			1 pc.
L5220013	Wooden shelf 85,5x46 cm with slots for two plastic drawers, for line 800			1 pc.
P1229909U	Plastic sliding drawer 10 L without locking key			2 pc.
P202051U	Long base with ø 125 mm wheels with 35 mm thread and ø 130 mm bumpers			1 pc.
P514000U	Bag support shelf with 125mm ø castor and 130mm ø bumpers			2 pc.
Q1400011E	Full 3-sided reinforced plastic-coated cloth back, grey			1 pc.
R1230110	Rilsan coated reinforcing rod for Morgan Hotel trolley, 81 cm			2 pc.
R2030161	Rilsan vertical frame with 2 bag holder retaining clips			2 pc.
R2060081	Rilsan 90l bag holder for Morgan Hotel Light trolleys			2 pc.

REF.	PCK	GROSS WEIGHT (kg)	SIZE (cm) ↓ ↓ ↓
<b>0000HP4373U</b>	1	33,8	135x55x130
0000AT0185E	90l self-standing Velcro bag, grey		1 pc.
I1900050	Galvanized steel rod 102 cm to fix the back panel		1 pc.
L0220013	Wooden shelf 85, 5x46 cm, for line 800		1 pc.
L5220013	Wooden shelf 85,5x46 cm with slots for two plastic drawers, for line 800		1 pc.
P1229909U	Plastic sliding drawer 10 L without locking key		2 pc.
P202051U	Long base with ø 125 mm wheels with 35 mm thread and ø 130 mm bumpers		1 pc.
P514000U	Bag support shelf with 125mm ø castor and 130mm ø bumpers		1 pc.
Q1400011E	Full 3-sided reinforced plastic-coated cloth back, grey		1 pc.
R1230110	Rilsan coated reinforcing rod for Morgan Hotel trolley, 81 cm		2 pc.
R2030161	Rilsan vertical frame with 2 bag holder retaining clips		2 pc.
R2060081	Rilsan 90l bag holder for Morgan Hotel Light trolleys		1 pc.

Suggested for 14 to 16 rooms

Suggested for 14 to 16 rooms

### ON REQUEST, WITH SURCHARGE





EMOTION

**MORGAN HOTEL ELEGANCE**

ALPHAHOTEL

SILVER

TROLLEYS FOR LAUNDRY COLLECTION

**MORGAN HOTEL LIGHT 4274** - trolley with wooden shelves

**NEW**



**MORGAN HOTEL LIGHT 4273** - trolley with wooden shelves

**NEW**



REF.	PCK	VOLUME (m³)	GROSS WEIGHT (kg)	SIZE (cm) ↓ ↓ ↓
<b>0000HP4274U</b>	1	0,342	37	155x55x130
0000AT0185E	90l self-standing Velcro bag, grey			2 pc.
I1900050	Galvanized steel rod 102 cm to fix the back panel			1 pc.
L0220013	Wooden shelf 85, 5x46 cm, for line 800			1 pc.
L5220013	Wooden shelf 85,5x46 cm with slots for two plastic drawers, for line 800			1 pc.
P1229909U	Plastic sliding drawer 10 L without locking key			2 pc.
P202051U	Long base with ø 125 mm wheels with 35 mm thread and ø 130 mm bumpers			1 pc.
Q1400011E	Full 3-sided reinforced plastic-coated cloth back, grey			1 pc.
R1230110	Rilsan coated reinforcing rod for Morgan Hotel trolley, 81 cm			2 pc.
R2030161	Rilsan vertical frame with 2 bag holder retaining clips			2 pc.
R2060081	Rilsan 90l bag holder for Morgan Hotel Light trolleys			2 pc.

Suggested for 14 to 16 rooms

**ON REQUEST, WITH SURCHARGE**

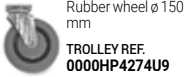

REF.	PCK	GROSS WEIGHT (kg)	SIZE (cm) ↓ ↓ ↓
<b>0000HP4273U</b>	1	31,48	128x55x130
0000AT0185E	90l self-standing Velcro bag, grey		1 pc.
I1900050	Galvanized steel rod 102 cm to fix the back panel		1 pc.
L0220013	Wooden shelf 85, 5x46 cm, for line 800		1 pc.
L5220013	Wooden shelf 85,5x46 cm with slots for two plastic drawers, for line 800		1 pc.
P1229909U	Plastic sliding drawer 10 L without locking key		2 pc.
P202051U	Long base with ø 125 mm wheels with 35 mm thread and ø 130 mm bumpers		1 pc.
Q1400011E	Full 3-sided reinforced plastic-coated cloth back, grey		1 pc.
R1230110	Rilsan coated reinforcing rod for Morgan Hotel trolley, 81 cm		2 pc.
R2030161	Rilsan vertical frame with 2 bag holder retaining clips		2 pc.
R2060081	Rilsan 90l bag holder for Morgan Hotel Light trolleys		1 pc.

Suggested for 14 to 16 rooms

**ON REQUEST, WITH SURCHARGE**



# Housekeeping trolleys



EMOTION

**MORGAN HOTEL ELEGANCE**

ALPHAHOTEL

SILVER

TROLLEYS FOR LAUNDRY COLLECTION

## Line 600

### MORGAN HOTEL 600 - trolley with wooden shelves



REF.	PCK	VOLUME (m <sup>3</sup> )	GROSS WEIGHT (kg)	SIZE (cm) ↓ ↓ ↓
<b>0000HP3300U</b>	1	0,307	26,54	88x49x130
.P130001Q	Door stopper made of plastic and rubber		1 pc.	
L0220014	Wooden shelf, 72,5x46 cm, for line 600		3 pcs	
P202008U	Short base with wheels ø 125 mm and tread 35 mm		1 pc.	
R1030122	Rilsan coated vertical frame, 111 cm high, for Hotel trolleys 600 and 800		2 pc.	
R1230111	Rilsan coated reinforcing rod, 68 cm, for Morgan Hotel trolley		2 pc.	

Suggested for 10-12 room service

#### ON REQUEST, WITH SURCHARGE



### MORGAN HOTEL 611 - trolley with wooden shelves



REF.	PCK	VOLUME (m <sup>3</sup> )	GROSS WEIGHT (kg)	SIZE (cm) ↓ ↓ ↓
<b>0000HP3301U</b>	1	0,307	29,14	88x49x130
.P130001Q	Door stopper made of plastic and rubber		1 pc.	
I1900050	Galvanized steel rod 102 cm to fix the back panel		1 pc.	
L0220014	Wooden shelf, 72,5x46 cm, for line 600		3 pcs	
P202008U	Short base with wheels ø 125 mm and tread 35 mm		1 pc.	
Q1400030G	Plastified and reinforced back and side panels (3 parts) for Line 600, brown and grey		1 pc.	
R1030122	Rilsan coated vertical frame, 111 cm high, for Hotel trolleys 600 and 800		2 pc.	
R1230111	Rilsan coated reinforcing rod, 68 cm, for Morgan Hotel trolley		2 pc.	

Suggested for 10-12 room service

#### ON REQUEST, WITH SURCHARGE





EMOTION

**MORGAN HOTEL ELEGANCE**

ALPHA HOTEL

SILVER

TROLLEYS FOR LAUNDRY COLLECTION

**MORGAN HOTEL 612** - trolley with wooden shelves



**MORGAN HOTEL 613** - trolley with wooden shelves



REF.	PCK	VOLUME (m³)	GROSS WEIGHT (kg)	SIZE (cm) ↓ ↓ ↓
<b>0000HP3302U</b>	1	0,307	33,54	126x52x130
.P130001Q	Door stopper made of plastic and rubber		1 pc.	
I1900050	Galvanized steel rod 102 cm to fix the back panel		1 pc.	
L0220014	Wooden shelf, 72,5x46 cm, for line 600		3 pcs	
P202008U	Short base with wheels ø 125 mm and tread 35 mm		1 pc.	
P314001U	Supporting plastic plate with wheel ø 125 mm		1 pc.	
P816010U	Plastic bag holder 120 L with push-bar, bag-stretchers and reinforcements		1 pc.	
Q1400030G	Plastified and reinforced back and side panels (3 parts) for Line 600, brown and grey		1 pc.	
R1030122	Rilsan coated vertical frame, 111 cm high, for Hotel trolleys 600 and 800		2 pc.	
R1230111	Rilsan coated reinforcing rod, 68 cm, for Morgan Hotel trolley		2 pc.	

REF.	PCK	VOLUME (m³)	GROSS WEIGHT (kg)	SIZE (cm) ↓ ↓ ↓
<b>0000HP3303U</b>	1	0,307	37,94	166x52x130
.P130001Q	Door stopper made of plastic and rubber		1 pc.	
I1900050	Galvanized steel rod 102 cm to fix the back panel		1 pc.	
L0220014	Wooden shelf, 72,5x46 cm, for line 600		3 pcs	
P202008U	Short base with wheels ø 125 mm and tread 35 mm		1 pc.	
P314001U	Supporting plastic plate with wheel ø 125 mm		2 pc.	
P816010U	Plastic bag holder 120 L with push-bar, bag-stretchers and reinforcements		2 pc.	
Q1400030G	Plastified and reinforced back and side panels (3 parts) for Line 600, brown and grey		1 pc.	
R1030122	Rilsan coated vertical frame, 111 cm high, for Hotel trolleys 600 and 800		2 pc.	
R1230111	Rilsan coated reinforcing rod, 68 cm, for Morgan Hotel trolley		2 pc.	

**ACCESSORIES TO ORDER AS SEPARATE ITEMS**

8057A	Polyester bag 55x55x94 cm, capacity 150 L, with blue stripe	1 pc.
-------	---	-------

Suggested for 10-12 room service

**ACCESSORIES TO ORDER AS SEPARATE ITEMS**

8057A	Polyester bag 55x55x94 cm, capacity 150 L, with blue stripe	2 pc.
-------	---	-------

Suggested for 10-12 room service

**ON REQUEST, WITH SURCHARGE**







EMOTION

**MORGAN HOTEL ELEGANCE**

ALPHA HOTEL

SILVER

TROLLEYS FOR LAUNDRY COLLECTION

## Line 800

### MORGAN HOTEL 614 - trolley with wooden shelves



### MORGAN HOTEL 800 - trolley with wooden shelves



REF.	PCK	VOLUME (m <sup>3</sup> )	GROSS WEIGHT (kg)	SIZE (cm) ↓ ↓ ↓
<b>0000HP4304U</b>	1	0,307	39,42	166x52x130
.P130001Q	Door stopper made of plastic and rubber			1 pc.
I1900050	Galvanized steel rod 102 cm to fix the back panel			1 pc.
L0220014	Wooden shelf, 72,5x46 cm, for line 600			2 pc.
L4220014	Wooden shelf 72,5x46 cm with slots for one plastic sliding drawer, for line 600			1 pc.
P202008U	Short base with wheels ø 125 mm and tread 35 mm			1 pc.
P2229909U	Plastic sliding drawer 10 L with lock			1 pc.
P314001U	Supporting plastic plate with wheel ø 125 mm			2 pc.
P816010U	Plastic bag holder 120 L with push-bar, bag-stretchers and reinforcements			2 pc.
Q1400030G	Plastified and reinforced back and side panels (3 parts) for Line 600, brown and grey			1 pc.
R1030122	Rilsan coated vertical frame, 111 cm high, for Hotel trolleys 600 and 800			2 pc.
R1230111	Rilsan coated reinforcing rod, 68 cm, for Morgan Hotel trolley			2 pc.

REF.	PCK	VOLUME (m <sup>3</sup> )	GROSS WEIGHT (kg)	SIZE (cm) ↓ ↓ ↓
<b>0000HP3360U</b>	1	0,307	29,64	102x49x130
.P130001Q	Door stopper made of plastic and rubber			1 pc.
L0220013	Wooden shelf 85,5x46 cm, for line 800			3 pcs
P202058U	Long base with wheels ø 125 mm and tread 35 mm			1 pc.
R1030122	Rilsan coated vertical frame, 111 cm high, for Hotel trolleys 600 and 800			2 pc.
R1230110	Rilsan coated reinforcing rod for Morgan Hotel trolley, 81 cm			2 pc.

Suggested for 14 to 16 rooms

### ON REQUEST, WITH SURCHARGE



### ACCESSORIES TO ORDER AS SEPARATE ITEMS

8057A	Polyester bag 55x55x94 cm, capacity 150 L, with blue stripe	2 pc.
-------	---	-------

Suggested for 10-12 room service

### ON REQUEST, WITH SURCHARGE





EMOTION

**MORGAN HOTEL ELEGANCE**

ALPHA HOTEL

SILVER

TROLLEYS FOR LAUNDRY COLLECTION

## MORGAN HOTEL 811 - trolley with wooden shelves



## MORGAN HOTEL 812 - trolley with wooden shelves



REF.	PCK	VOLUME (m³)	GROSS WEIGHT (kg)	SIZE (cm) ↓ ↓ ↓
<b>0000HP3361U</b>	1	0,307	32,44	102x49x130
.P130001Q	Door stopper made of plastic and rubber			1 pc.
I1900050	Galvanized steel rod 102 cm to fix the back panel			1 pc.
L0220013	Wooden shelf 85, 5x46 cm, for line 800			3 pcs
P202058U	Long base with wheels ø 125 mm and tread 35 mm			1 pc.
Q1400010G	Plastified and reinforced back and side panels (3 parts) for Line 800, brown and grey			1 pc.
R1030122	Rilsan coated vertical frame, 111 cm high, for Hotel trolleys 600 and 800			2 pc.
R1230110	Rilsan coated reinforcing rod for Morgan Hotel trolley, 81 cm			2 pc.

Suggested for 14 to 16 rooms

### ON REQUEST, WITH SURCHARGE



REF.	PCK	VOLUME (m³)	GROSS WEIGHT (kg)	SIZE (cm) ↓ ↓ ↓
<b>0000HP3362U</b>	1	0,307	36,84	140x52x130
.P130001Q	Door stopper made of plastic and rubber			1 pc.
I1900050	Galvanized steel rod 102 cm to fix the back panel			1 pc.
L0220013	Wooden shelf 85, 5x46 cm, for line 800			3 pcs
P202058U	Long base with wheels ø 125 mm and tread 35 mm			1 pc.
P314001U	Supporting plastic plate with wheel ø 125 mm			1 pc.
P816010U	Plastic bag holder 120 L with push-bar, bag-stretchers and reinforcements			1 pc.
Q1400010G	Plastified and reinforced back and side panels (3 parts) for Line 800, brown and grey			1 pc.
R1030122	Rilsan coated vertical frame, 111 cm high, for Hotel trolleys 600 and 800			2 pc.
R1230110	Rilsan coated reinforcing rod for Morgan Hotel trolley, 81 cm			2 pc.

### ACCESSORIES TO ORDER AS SEPARATE ITEMS

8057A	Polyester bag 55x55x94 cm, capacity 150 L, with blue stripe	1 pc.
-------	---	-------

Suggested for 14 to 16 rooms

### ON REQUEST, WITH SURCHARGE



# Housekeeping trolleys



EMOTION

**MORGAN HOTEL ELEGANCE**

ALPHA HOTEL

SILVER

TROLLEYS FOR LAUNDRY COLLECTION

## MORGAN HOTEL 813 - trolley with wooden shelves



## MORGAN HOTEL 814 - trolley with wooden shelves



REF.	PCK	VOLUME (m³)	GROSS WEIGHT (kg)	SIZE (cm) ↓ ↓ ↓
<b>0000HP3363U</b>	1	0,307	41,24	178x52x130
.P130001Q	Door stopper made of plastic and rubber		1 pc.	
I1900050	Galvanized steel rod 102 cm to fix the back panel		1 pc.	
L0220013	Wooden shelf 85, 5x46 cm, for line 800		3 pcs	
P202058U	Long base with wheels ø 125 mm and tread 35 mm		1 pc.	
P314001U	Supporting plastic plate with wheel ø 125 mm		2 pc.	
P816010U	Plastic bag holder 120 L with push-bar, bag-stretchers and reinforcements		2 pc.	
Q1400010G	Plastified and reinforced back and side panels (3 parts) for Line 800, brown and grey		1 pc.	
R1030122	Rilsan coated vertical frame, 111 cm high, for Hotel trolleys 600 and 800		2 pc.	
R1230110	Rilsan coated reinforcing rod for Morgan Hotel trolley, 81 cm		2 pc.	

### ACCESSORIES TO ORDER AS SEPARATE ITEMS

8057A	Polyester bag 55x55x94 cm, capacity 150 L, with blue stripe	2 pc.
-------	---	-------

Suggested for 14 to 16 rooms

### ON REQUEST, WITH SURCHARGE



Rubber wheel ø 150 mm

TROLLEY REF.  
**0000HP3363U9**

REF.	PCK	VOLUME (m³)	GROSS WEIGHT (kg)	SIZE (cm) ↓ ↓ ↓
<b>0000HP4364U</b>	1	0,342	43,27	177x52x130
.P130001Q	Door stopper made of plastic and rubber		1 pc.	
I1900050	Galvanized steel rod 102 cm to fix the back panel		1 pc.	
L0220013	Wooden shelf 85, 5x46 cm, for line 800		2 pc.	
L5220013	Wooden shelf 85, 5x46 cm with slots for two plastic drawers, for line 800		1 pc.	
P202058U	Long base with wheels ø 125 mm and tread 35 mm		1 pc.	
P2229909U	Plastic sliding drawer 10 L with lock		2 pc.	
P314001U	Supporting plastic plate with wheel ø 125 mm		2 pc.	
P816010U	Plastic bag holder 120 L with push-bar, bag-stretchers and reinforcements		2 pc.	
Q1400010G	Plastified and reinforced back and side panels (3 parts) for Line 800, brown and grey		1 pc.	
R1030122	Rilsan coated vertical frame, 111 cm high, for Hotel trolleys 600 and 800		2 pc.	
R1230110	Rilsan coated reinforcing rod for Morgan Hotel trolley, 81 cm		2 pc.	

### ACCESSORIES TO ORDER AS SEPARATE ITEMS

8057A	Polyester bag 55x55x94 cm, capacity 150 L, with blue stripe	2 pc.
-------	---	-------

Suggested for 14 to 16 rooms

### ON REQUEST, WITH SURCHARGE



Rubber wheel ø 150 mm

TROLLEY REF.  
**0000HP4364U9**



EMOTION

**MORGAN HOTEL ELEGANCE**

ALPHAHOTEL

SILVER

TROLLEYS FOR LAUNDRY COLLECTION

**MORGAN HOTEL 851** - trolley with wooden shelves



**MORGAN HOTEL 852** - trolley with wooden shelves



REF.	PCK	VOLUME (m³)	GROSS WEIGHT (kg)	SIZE (cm) ↓ ↓ ↓
<b>0000HP3341U</b>	1	0,307	26,6	104x52x130
.P130001Q	Door stopper made of plastic and rubber			1 pc.
L0220015	Wooden shelf 50x46 cm for Hotel trolleys 851, 852 and 853			3 pcs
P202058U	Long base with wheels ø 125 mm and tread 35 mm			1 pc.
P816010U	Plastic bag holder 120 L with push-bar, bag-stretchers and reinforcements			1 pc.
Q1400130G	Plastified and reinforced back and side panels (3 parts) for Line 851 and 852, brown and grey			1 pc.
R1030122	Rilsan coated vertical frame, 111 cm high, for Hotel trolleys 600 and 800			2 pc.
R1230112	Rilsan coated reinforcing rod, 46 cm, for Morgan Hotel trolley			2 pc.

REF.	PCK	VOLUME (m³)	GROSS WEIGHT (kg)	SIZE (cm) ↓ ↓ ↓
<b>0000HP3342U</b>	1	0,307	29,34	140x52x130
.P130001Q	Door stopper made of plastic and rubber			1 pc.
L0220015	Wooden shelf 50x46 cm for Hotel trolleys 851, 852 and 853			3 pcs
P202058U	Long base with wheels ø 125 mm and tread 35 mm			1 pc.
P314001U	Supporting plastic plate with wheel ø 125 mm			1 pc.
P816010U	Plastic bag holder 120 L with push-bar, bag-stretchers and reinforcements			1 pc.
Q1400130G	Plastified and reinforced back and side panels (3 parts) for Line 851 and 852, brown and grey			1 pc.
R1030122	Rilsan coated vertical frame, 111 cm high, for Hotel trolleys 600 and 800			2 pc.
R1230112	Rilsan coated reinforcing rod, 46 cm, for Morgan Hotel trolley			2 pc.

**ACCESSORIES TO ORDER AS SEPARATE ITEMS**

8057A	Polyester bag 55x55x94 cm, capacity 150 L, with blue stripe	1 pc.
-------	---	-------

Suggested for 6 to 8 rooms

**ON REQUEST, WITH SURCHARGE**



**ACCESSORIES TO ORDER AS SEPARATE ITEMS**

8057A	Polyester bag 55x55x94 cm, capacity 150 L, with blue stripe	1 pc.
-------	---	-------

Suggested for 6 to 8 rooms

**ON REQUEST, WITH SURCHARGE**





EMOTION

**MORGAN HOTEL ELEGANCE**

ALPHAHOTEL

SILVER

TROLLEYS FOR LAUNDRY COLLECTION

## Trolleys for laundry collection

### MORGAN HOTEL 853 - trolley with wooden shelves



REF.	PCK	VOLUME (m³)	GROSS WEIGHT (kg)	SIZE (cm) ↓ ↓ ↓
<b>0000HP3343U</b>	1	0,307	28,14	104x52x130
.P130001Q	Door stopper made of plastic and rubber			1 pc.
L0220015	Wooden shelf 50x46 cm for Hotel trolleys 851, 852 and 853			3 pcs
P202058U	Long base with wheels ø 125 mm and tread 35 mm			1 pc.
P816010U	Plastic bag holder 120 L with push-bar, bag-stretchers and reinforcements			1 pc.
Q0400070G	Plastified and reinforced side panel with pockets, brown and grey			1 pc.
Q1400210G	Plastified and reinforced back and one side (2 parts) for Line 853, brown and grey			1 pc.
R1030122	Rilsan coated vertical frame, 111 cm high, for Hotel trolleys 600 and 800			2 pc.
R1230112	Rilsan coated reinforcing rod, 46 cm, for Morgan Hotel trolley			2 pc.

### ACCESSORIES TO ORDER AS SEPARATE ITEMS

8057A	Polyester bag 55x55x94 cm, capacity 150 L, with blue stripe	1 pc.
-------	---	-------

Suggested for 6 to 8 rooms

### ON REQUEST, WITH SURCHARGE



### LAUNDRY TROLLEY 3100 - trolley with bag



REF.	PCK	VOLUME (m³)	GROSS WEIGHT (kg)	SIZE (cm) ↓ ↓ ↓
<b>0000HP3100U</b>	1	0,166	11,8	88x49x88
.P130001Q	Door stopper made of plastic and rubber			1 pc.
P202008U	Short base with wheels ø 125 mm and tread 35 mm			1 pc.
Q0400102G	Brown plastified bag 200 L for laundry collection trolley with zip			1 pc.
R1030113	Rilsan coated vertical frame for laundry collection trolleys art. 0000HP3100U and 0000HP3110U			2 pc.

### ON REQUEST, WITH SURCHARGE





EMOTION

**MORGAN HOTEL ELEGANCE**

ALPHAHOTEL

SILVER

TROLLEYS FOR LAUNDRY COLLECTION

## LAUNDRY TROLLEY 3110 - trolley with bag



## LAUNDRY TROLLEY 3140 - trolley with bag



REF.	PCK	VOLUME (m³)	GROSS WEIGHT (kg)	SIZE (cm) ↓ ↓ ↓
<b>0000HP3110U</b>	1	0,166	11,94	88x49x88
.P130001Q	Door stopper made of plastic and rubber			1 pc.
P202008U	Short base with wheels ø 125 mm and tread 35 mm			1 pc.
Q0400103G	Brown plastified bag 200 L for laundry collection trolley with zip and closure			1 pc.
R1030113	Rilsan coated vertical frame for laundry collection trolleys art. 0000HP3100U and 0000HP3110U			2 pc.

REF.	PCK	VOLUME (m³)	GROSS WEIGHT (kg)	SIZE (cm) ↓ ↓ ↓
<b>0000HP3140U</b>	1	0,191	18,48	126x52x108
.P130001Q	Door stopper made of plastic and rubber			1 pc.
P202008U	Short base with wheels ø 125 mm and tread 35 mm			1 pc.
P314001U	Supporting plastic plate with wheel ø 125 mm			1 pc.
P816010U	Plastic bag holder 120 L with push-bar, bag-stretchers and reinforcements			1 pc.
Q0400103G	Brown plastified bag 200 L for laundry collection trolley with zip and closure			1 pc.
R1030142	Rilsan coated vertical frame for laundry collection trolley art. 0000HP3140U			2 pc.
R1230113	Rilsan coated reinforcing rod, 66 cm, for Morgan Hotel trolley			2 pc.

### ON REQUEST, WITH SURCHARGE

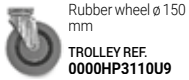

### ACCESSORIES TO ORDER AS SEPARATE ITEMS

8057A	Polyester bag 55x55x94 cm, capacity 150 L, with blue stripe	1 pc.
-------	---	-------

### ON REQUEST, WITH SURCHARGE



# Housekeeping trolleys



EMOTION

**MORGAN HOTEL ELEGANCE**

ALPHAHOTEL

SILVER

TROLLEYS FOR LAUNDRY  
COLLECTION

## LAUNDRY TROLLEY 3101 - trolley with bag



REF.	PCK	VOLUME (m³)	GROSS WEIGHT (kg)	SIZE (cm) ↓ ↓ ↓
<b>0000HP3101U</b>	1	0,244	16	105x49x105

.P130001Q	Door stopper made of plastic and rubber	1 pc.
P202058U	Long base with wheels ø 125 mm and tread 35 mm	1 pc.
Q0400101G	Brown plastified bag 300 L for laundry collection trolley with zip	1 pc.
R1030144	Rilsan coated vertical frame for laundry collection trolley art. 0000HP3101U	2 pc.

### ON REQUEST, WITH SURCHARGE



Rubber wheel ø 150 mm

TROLLEY REF.  
**0000HP3101U9**

## LAUNDRY TROLLEY 3100 - trolley with bag



REF.	PCK	VOLUME (m³)	GROSS WEIGHT (kg)	SIZE (cm) ↓ ↓ ↓
<b>0000HP3103U</b>	1	0,236	19,5	88x49x152,5

.P130001Q	Door stopper made of plastic and rubber	1 pc.
P202008U	Short base with wheels ø 125 mm and tread 35 mm	1 pc.
Q0400122P	Brown plastified bag 600 L for laundry collection trolley with front zip	1 pc.
R1030146	Rilsan coated vertical frame for laundry collection trolley art. 0000HP3103U	2 pc.
R1230113	Rilsan coated reinforcing rod, 66 cm, for Morgan Hotel trolley	6 pcs

### ON REQUEST, WITH SURCHARGE



Rubber wheel ø 150 mm

TROLLEY REF.  
**0000HP3103U9**



EMOTION

**MORGAN HOTEL ELEGANCE**

ALPHAHOTEL

SILVER

TROLLEYS FOR LAUNDRY COLLECTION

## Components and accessories for Morgan Hotel Elegance trolleys

### Short plastic base



REF.	NOTES	SIZE (cm) ↓ ↓ ↓
P202008U	with wheels ø 125 mm and tread 35 mm	92x49
P202012U	with rubber wheels ø 150 mm	92x49

### Long plastic base



REF.	NOTES	SIZE (cm) ↓ ↓ ↓
P202058U	with wheels ø 125 mm and tread 35 mm	105x49
P202063U	with rubber wheels ø 150 mm	105x49

### Large plastic base for Light series



REF.	NOTES
P202051U	with ø 125 mm wheels with 35 mm thread and ø 130 mm bumpers
P202075U	with ø 150 mm rubber wheels and ø 130 mm bumpers

**NEW**

### Supporting plastic plate with wheel



REF.	NOTES
P314001U	with wheel ø 125 mm
P314005U	with rubber wheel ø 125 mm

### Supporting plastic plate with wheel and bumpers ø 200 mm



REF.	NOTES
P414001U	with wheel ø 125 mm
P414005U	with rubber wheel ø 125 mm

### Bag support shelf for Light series



REF.	NOTES
P514000U	

**NEW**



# Housekeeping trolleys



EMOTION

**MORGAN HOTEL ELEGANCE**

ALPHAHOTEL

SILVER

TROLLEYS FOR LAUNDRY COLLECTION

Supporting plastic plate for bucket 10 and 20 L fitting Morgan base



REF.	NOTES	SIZE (cm) ↓ ↓ ↓
P064000A		48x22x15
P064000U		48x22x15

Base extension for Alpha trolleys and for the bag supporting plastic plate of the Morgan Hotel Elegance trolleys



REF.	NOTES	SIZE (cm) ↓ ↓ ↓
P165000U		48x22x15

Rilsan coated vertical frame, 111 cm high, for Hotel trolleys 600 and 800



REF.	NOTES
R1030122	

Rilsan vertical frame with 2 bag holder retaining clips for Light series



REF.	NOTES
R2030161	

**NEW**

Rilsan coated vertical frame for laundry collection trolley



REF.	NOTES
R1030113	for art. 0000HP3100U and 0000HP3110U
R1030142	for art. 0000HP3140U
R1030144	for art. 0000HP3101U
R1030146	for art. 0000HP3103U

Rilsan coated reinforcing rod



REF.	NOTES	SIZE (cm) ↓ ↓ ↓
R1230110		81
R1230111		68
R1230112		46
R1230113		66



EMOTION

**MORGAN HOTEL ELEGANCE**

ALPHAHOTEL

SILVER

TROLLEYS FOR LAUNDRY COLLECTION

## Wooden shelf



REF.	NOTES	SIZE (cm) ↓ ↓ ↓
L0220014	for line 600	72,5x46

## Fixing screw set for shelves



REF.	NOTES
0000SM00602	for 3 shelves (12 screws)
0000SM00603	for 2 shelves (8 screws)
0000SM00607	for 1 shelf (4 screws)

## Wooden shelf with slots for one plastic sliding drawer



REF.	NOTES	SIZE (cm) ↓ ↓ ↓
L4220013	for line 800	85,5x46
L4220014	for line 600	72,5x46
L4220015	for trolleys 851, 852 and 853	50x46

## Wooden shelf with slots for two plastic drawers



REF.	NOTES	SIZE (cm) ↓ ↓ ↓
L5220013	for line 800	85,5x46

## Plastic sliding drawer without locking key



REF.	NOTES	CAPACITY (L)	SIZE (cm) ↓ ↓ ↓
P1229909U	internal dimensions 41x34x9,5 cm	10	46,5x37,5x11
P1229906U	internal dimensions 40,5x34x16 cm	22	46,5x37,5x17
P1229907U	internal dimensions 40x34x33,5 cm	40	46,5x37,5x35



## Plastic sliding drawer with locking key



REF.	NOTES	CAPACITY (L)	SIZE (cm) ↓ ↓ ↓
P2229909U	internal dimensions 41x34x9,5 cm	10	46,5x37,5x11
P2229906A	internal dimensions 40,5x34x16 cm	22	46,5x37,5x17
P2229906B	internal dimensions 40,5x34x16 cm	22	46,5x37,5x17
P2229906U	internal dimensions 40,5x34x16 cm	22	46,5x37,5x17
P2229907U	internal dimensions 40x34x33,5 cm	40	46,5x37,5x35



# Housekeeping trolleys



EMOTION

**MORGAN HOTEL ELEGANCE**

ALPHAHOTEL

SILVER

TROLLEYS FOR LAUNDRY COLLECTION

Plastic divider for drawer 10 L



REF.	NOTES
0000SM00227D	9 compartments
0000SM00228D	12 compartments

Set of 1 big divider 39 cm + 1 medium divider 32 cm for plastic sliding drawer 22 L

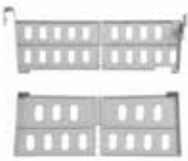

REF.	NOTES
0000SM00213U	

Set of 1 big divider 39 cm + 3 small dividers 16 cm for plastic sliding drawer 22 L

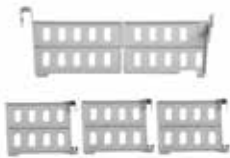

REF.	NOTES
0000SM00214U	

Galvanized steel rod 102 cm to fix the back panel

REF.	NOTES
I1900050	

Plastified and reinforced back and side panels (3 parts), brown and grey



REF.	NOTES	SIZE (cm)
Q1400010G	for line 800	178x103,5
Q1400030G	for line 600	165x103,5

Plastified and reinforced back and side panels (3 parts) for Line 851 and 852, brown and grey



REF.	NOTES	SIZE (cm)
Q1400130G		144x103,5

Full 3-sided grey reinforced plastic-coated cloth back, for Light series

**NEW**



REF.	NOTES
Q1400011E	



EMOTION

**MORGAN HOTEL ELEGANCE**

ALPHAHOTEL

SILVER

TROLLEYS FOR LAUNDRY COLLECTION

Plastified and reinforced panel, brown and grey



REF.	NOTES	SIZE (cm) ↓ ↓ ↓
<b>Q1400090G</b>	for line 800	87x103,5
<b>Q1400110G</b>	for line 600	73x103,5

Plastified and reinforced back and one side (2 parts) for Line 853, brown and grey



REF.	NOTES	SIZE (cm) ↓ ↓ ↓
<b>Q1400210G</b>		97x103,5

Plastified and reinforced smooth side panel (2 pcs), brown and grey



REF.	NOTES	SIZE (cm) ↓ ↓ ↓
<b>Q1400050G</b>		47x103,5

Plastified and reinforced side panel with pockets, brown and grey



REF.	NOTES	SIZE (cm) ↓ ↓ ↓
<b>Q0400070G</b>		47x103,5

Brown plastified bag for laundry collection with zip



REF.	NOTES	CAPACITY (L)
<b>Q0400101G</b>		300
<b>Q0400102G</b>		200

Brown plastified bag 200 L for laundry collection trolley with zip and closure



REF.	NOTES
<b>Q0400103G</b>	

# Housekeeping trolleys



EMOTION

**MORGAN HOTEL ELEGANCE**

ALPHAHOTEL

SILVER

TROLLEYS FOR LAUNDRY COLLECTION

Brown plastified bag 600 L for laundry collection trolley with front zip



REF.	NOTES
<b>Q0400122P</b>	

90l self-standing Velcro bag

**NEW**



REF.	NOTES
<b>0000AT0185E</b>	

For Morgan Hotel Light trolley bag holder

Brown plastified front covering



REF.	NOTES
<b>Q0400220G</b>	for line 600
<b>Q0400230G</b>	for line 800 (except versions 851-852-853)

Brown plastified front covering with elastic



REF.	NOTES
<b>Q0400221G</b>	for line 600
<b>Q0400231G</b>	for line 800 (except versions 851-852-853)

Plastic bag holder 120 L with push-bar, bag-stretchers and reinforcements



REF.	NOTES
<b>P816010U</b>	

Plastic bag holder 2x60 L with push-bar, bag-stretchers and reinforcements



REF.	NOTES
<b>P516010U</b>	

Rilsan 90l bag holder for Morgan Hotel Light

**NEW**



REF.	NOTES
<b>R2060081</b>	



EMOTION

**MORGAN HOTEL ELEGANCE**

ALPHAHOTEL

SILVER

TROLLEYS FOR LAUNDRY COLLECTION

Plastic cover for bag holder 120 L with storage room, check-list holder and lock

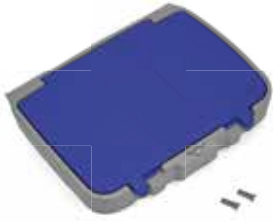

REF.	NOTES
P291920UA	
P291920UB	
P291920U	



Please, require also no. 2 shock absorbing pistons art. P190908U for a perfect soft closing

Shock absorbing piston for a soft closing of the cover



REF.	NOTES
P190908U	



Plastic tray for guest amenities



REF.	NOTES	SIZE (cm)
P219004U		28x43x9
P219005U		55x43x9

Plastified tray for guest amenities



REF.	NOTES	SIZE (cm)
Q0400104		66x46
Q0400117		43x46

Rilsan coated coupling device to connect the laundry trolley to the Morgan Hotel trolleys



REF.	NOTES
R1180050	

Bathrobe holder kit with pockets complete with double fixing clip with screws



REF.	NOTES
Q1400118U	

Recommended with bag supporting plastic plate

# Housekeeping trolleys



EMOTION

**MORGAN HOTEL ELEGANCE**

ALPHAHOTEL

SILVER

TROLLEYS FOR LAUNDRY COLLECTION

Rilsan coated holder for paper-rolls and paper-towels



REF.	NOTES
<b>R1900050</b>	

Rilsan coated external vertical frame h 109 cm complete with 2 fixing clips (special shaped in the lower part)



REF.	NOTES
<b>R2030106</b>	

Side plastic basket for Morgan Hotel fitting vertical frame ref. R2030106



REF.	NOTES
<b>P119002U</b>	internal dimensions 49,5x18,5x11 cm

Rilsan coated support 70 L with bag stretcher fitting special shaped vertical frame



REF.	NOTES
<b>R2060080</b>	

Grey waste collection bin 16 L with handle



REF.	NOTES	CAPACITY (L)	SIZE (cm)
<b>8168U</b>		16	26x16x50

Rilsan coated holder for plastic bin 16 L, fitting special shaped vertical frame



REF.	NOTES
<b>R2200050</b>	



EMOTION

**MORGAN HOTEL ELEGANCE**

ALPHAHOTEL

SILVER

TROLLEYS FOR LAUNDRY COLLECTION

Rilsan coated vertical frame 52 cm high complete with 4 fixing clips



REF.	NOTES
<b>R3030135</b>	

Rilsan coated basket holder for basket art. P1191100U fitting vertical frame art. R2030135



REF.	NOTES
<b>R2200051</b>	

Side plastic basket



REF.	NOTES
<b>P1191100U</b>	external dimension 49x22x11,5 cm



Rilsan coated bucket holder for buckets 10 and 20 L fitting Morgan vertical frame and Alpha trolley

REF.	NOTES
<b>R2200040</b>	







## Alpha Hotel: new skills for a more functional and comfortable service trolley.

**Alpha Hotel** trolleys have a plain and simple design to fit any environment. Completely made of polypropylene, from the base, the vertical frames, the shelves to all their accessories, they are available in different versions: completely open or with closing panels and doors for the highest safety.

The Alpha Hotel range features utmost care of all details and a specific design conceived to ensure practicality, efficiency and functionality.



### Better functionality

The models with two storage units have a left opening door, for **convenience** and **practicality**.



Innovative closing mechanism to work safe

### Organize your services and work better

The versions without central vertical frame ensure **high trolley capacity**, so that everything that may be needed for the job can be right at hand.



### **NEW** Alpha Hotel Drive

Alpha Hotel Drive Trolleys can be used to move loads of up to 150 kg on several types of floors with slopes up to 12°, **without any strain** for the operator. Motor-driven trolleys are **easy to manoeuvre**, do not need to be pushed and provide **maximum safety**. Being **extremely quiet**, they do not cause disturbance, and are therefore ideal for cleaning and tidying activities inside welcoming establishments

### Unhook the trolley and go

Thanks to **Link-Up, the new hook system** designed by Filmop, it will be possible to separate the bag holder compartment from the rest of the trolley with a simple click.

The **new independent waste collection unit** allows to move around more freely and comfortably during all waste or laundry disposal operations and to gain access easier to small and reduced areas, such as elevators, small hallways and laundries.

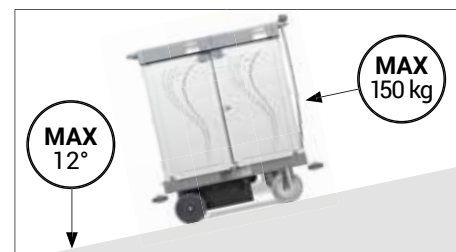



EMOTION

MORGAN HOTEL ELEGANCE

**ALPHA HOTEL**

SILVER

TROLLEYS FOR LAUNDRY COLLECTION

## Alpha Hotel Drive

### ALPHA HOTEL DRIVE 0648005 - plastic trolley

**NEW**

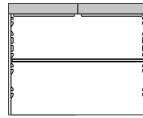

### ALPHA HOTEL DRIVE 0648003 - plastic trolley

**NEW**

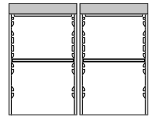

REF.	PCK	VOLUME (m <sup>3</sup> )	GROSS WEIGHT (kg)	SIZE (cm)
<b>HA0648005U000</b>	1	1,71	66	97x58x114

.P130001Q	Door stopper made of plastic and rubber	1 pc.
0000SM00033E	Blocking device for side walls for Alpha trolleys	1 pc.
0000SM00165	Set of T-shaped light grey closing plugs for vertical frames (6 pcs)	2 pc.
P2039903E	Vertical frame, 1 side with slides + 1 side for T-plugs, complete with screws and plugs	2 pc.
P2229911U	Plastic Shelf 46,5x79 cm	1 pc.
P266481U	Long base with 2 ø 200x45 mm wheels, 4 bumpers and motor kit	1 pc.
P2909920U	Closing profile for central basket/bag holder complete with screws and plugs	1 pc.
P2909921U	Closing profile with push-grip for central basket complete with screws and plugs	1 pc.
P3059953E	Fixed side wall with fixing pins	2 pc.
P3059977E	Right and left wing door set for Alpha trolleys	1 pc.
P3199908U	Set of 2 central upper baskets with swing door support, screws and plugs	1 pc.

#### ACCESSORIES TO ORDER AS SEPARATE ITEMS

00BL1000	Lithium battery	1 pc.
----------	-----------------	-------

Suggested for 8 to 10 rooms

#### ON REQUEST, WITH SURCHARGE



wheels with rubber tyres for exterior use ø 200x50 mm

TROLLEY REF.  
**HA0649005U000**

REF.	PCK	VOLUME (m <sup>3</sup> )	GROSS WEIGHT (kg)	SIZE (cm)
<b>HA0648003U000</b>	1	1,71	66,8	142x58x114

.P130001Q	Door stopper made of plastic and rubber	1 pc.
0000SM00165	Set of T-shaped light grey closing plugs for vertical frames (6 pcs)	2 pc.
P066481U	Long base with 2 ø 200x45 mm wheels, 2 bumpers and motor kit	1 pc.
P1229900U	Set of plastic shelves (2 pcs)	2 pc.
P2039903E	Vertical frame, 1 side with slides + 1 side for T-plugs, complete with screws and plugs	2 pc.
P2039904E	Vertical frame, 2 sides with slides, complete with screws and plugs	1 pc.
P2199906U	Central plastic basket (female-female version) complete with caps	1 pc.
P2199907U	Central plastic basket (male-female version) complete with screws and caps	1 pc.
P2909921U	Closing profile with push-grip for central basket complete with screws and plugs	1 pc.
P3059953E	Fixed side wall with fixing pins	2 pc.
P3059954E	Right door with fixing pins	1 pc.
P3059974E	Left door with fixing pins	1 pc.
P375000U	Supporting plate with bumpers for Alpha	1 pc.
P8161113U	Folding 120L waste bag holder, with bag retaining hooks, dustpan hook, handle clip, screws and plugs	1 pc.

#### ACCESSORIES TO ORDER AS SEPARATE ITEMS

0000AT0120E	Grey plastic-coated bag 73x97,5 cm, capacity 120 L, with bottom grip	1 pc.
00BL1000	Lithium battery	1 pc.

Suggested for 8 to 10 rooms

#### ON REQUEST, WITH SURCHARGE



wheels with rubber tyres for exterior use ø 200x50 mm

TROLLEY REF.  
**HA0649003U000**



EMOTION

MORGAN HOTEL ELEGANCE

ALPHA HOTEL

SILVER

TROLLEYS FOR LAUNDRY COLLECTION

## Trolleys with Link-Up system

### ALPHA HOTEL HR5300-98 - plastic trolley with Link-Up system



REF.	PCK	VOLUME (m <sup>3</sup> )	GROSS WEIGHT (kg)	SIZE (cm) ↓ ↓ ↓
<b>0300HR5300U98</b>	1	0,438	33,65	153x58x107

.P130001Q	Door stopper made of plastic and rubber	1 pc.
0000SM00033E	Blocking device for side walls for Alpha trolleys	1 pc.
0000SM00163	Set of T-shaped dark grey closing plugs for vertical frames (6 pcs)	1 pc.
0000SM00165	Set of T-shaped light grey closing plugs for vertical frames (6 pcs)	2 pc.
0000SM00617	Quick connection kit Link-Up to fix Alpha vertical frames	1 pc.
P025031U	Compact base with wheels ø 125 mm	1 pc.
P066031U	Long base with rubber wheels ø 125 mm	1 pc.
P1909967U	Closing profile for bag holder 120 L	1 pc.
P2031103U	Vertical frame with reinforcement, 1 smooth side + 1 side for T-plugs, complete with screws	1 pc.
P2039903E	Vertical frame, 1 side with slides + 1 side for T-plugs, complete with screws and plugs	2 pc.
P2199904U	Set with 2 central basket, screws and plugs	1 pc.
P2229911U	Plastic Shelf 46,5x79 cm	1 pc.
P2909920U	Closing profile for central basket/bag holder complete with screws and plugs	1 pc.
P2909921U	Closing profile with push-grip for central basket complete with screws and plugs	1 pc.
P3059953E	Fixed side wall with fixing pins	2 pc.
P8161111U	120l waste bag holder, male fitting, with dustpan hook and handle clip	1 pc.

#### ACCESSORIES TO ORDER AS SEPARATE ITEMS

0000AT0120E	Grey plastic-coated bag 73x97,5 cm, capacity 120 L, with bottom grip	1 pc.
-------------	--	-------

Suggested for 8 to 10 rooms

### ALPHA HOTEL HR0603003 - plastic trolley with Link-Up system



REF.	PCK	VOLUME (m <sup>3</sup> )	GROSS WEIGHT (kg)	SIZE (cm) ↓ ↓ ↓
<b>HR0603003U000</b>	1	0,549	45	153x58x107

.P130001Q	Door stopper made of plastic and rubber	1 pc.
0000SM00163	Set of T-shaped dark grey closing plugs for vertical frames (6 pcs)	1 pc.
0000SM00165	Set of T-shaped light grey closing plugs for vertical frames (6 pcs)	2 pc.
0000SM00617	Quick connection kit Link-Up to fix Alpha vertical frames	1 pc.
P025031U	Compact base with wheels ø 125 mm	1 pc.
P066031U	Long base with rubber wheels ø 125 mm	1 pc.
P1229900U	Set of plastic shelves (2 pcs)	2 pc.
P1909967U	Closing profile for bag holder 120 L	1 pc.
P2031103U	Vertical frame with reinforcement, 1 smooth side + 1 side for T-plugs, complete with screws	1 pc.
P2039903E	Vertical frame, 1 side with slides + 1 side for T-plugs, complete with screws and plugs	2 pc.
P2039904E	Vertical frame, 2 sides with slides, complete with screws and plugs	1 pc.
P2199906U	Central plastic basket (female-female version) complete with caps	1 pc.
P2199907U	Central plastic basket (male-female version) complete with screws and caps	1 pc.
P2909920U	Closing profile for central basket/bag holder complete with screws and plugs	1 pc.
P2909921U	Closing profile with push-grip for central basket complete with screws and plugs	1 pc.
P3059953E	Fixed side wall with fixing pins	2 pc.
P3059954E	Right door with fixing pins	1 pc.
P3059974E	Left door with fixing pins	1 pc.
P8161111U	120l waste bag holder, male fitting, with dustpan hook and handle clip	1 pc.

#### ACCESSORIES TO ORDER AS SEPARATE ITEMS

0000AT0120E	Grey plastic-coated bag 73x97,5 cm, capacity 120 L, with bottom grip	1 pc.
-------------	--	-------

Suggested for 8 to 10 rooms



EMOTION

MORGAN HOTEL ELEGANCE

**ALPHA HOTEL**

SILVER

TROLLEYS FOR LAUNDRY COLLECTION

## Open version trolleys

### ALPHA HOTEL HR0603006 - plastic trolley with Link-Up system

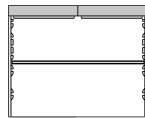

REF.	PCK	VOLUME (m <sup>3</sup> )	GROSS WEIGHT (kg)	SIZE (cm)
<b>HR0603006U000</b>	1	0,487	42,5	153x58x107

.P130001Q	Door stopper made of plastic and rubber	1 pc.
0000SM00033E	Blocking device for side walls for Alpha trolleys	1 pc.
0000SM00163	Set of T-shaped dark grey closing plugs for vertical frames (6 pcs)	1 pc.
0000SM00165	Set of T-shaped light grey closing plugs for vertical frames (6 pcs)	2 pc.
0000SM00617	Quick connection kit Link-Up to fix Alpha vertical frames	1 pc.
P025031U	Compact base with wheels ø 125 mm	1 pc.
P066031U	Long base with rubber wheels ø 125 mm	1 pc.
P1909967U	Closing profile for bag holder 120 L	1 pc.
P2031103U	Vertical frame with reinforcement, 1 smooth side + 1 side for T-plugs, complete with screws	1 pc.
P2039903E	Vertical frame, 1 side with slides + 1 side for T-plugs, complete with screws and plugs	2 pc.
P2229911U	Plastic Shelf 46,5x79 cm	1 pc.
P2909920U	Closing profile for central basket/bag holder complete with screws and plugs	1 pc.
P2909921U	Closing profile with push-grip for central basket complete with screws and plugs	1 pc.
P3059953E	Fixed side wall with fixing pins	2 pc.
P3059977E	Right and left wing door set for Alpha trolleys	1 pc.
P3199908U	Set of 2 central upper baskets with swing door support, screws and plugs	1 pc.
P8161111U	120l waste bag holder, male fitting, with dustpan hook and handle clip	1 pc.

### ACCESSORIES TO ORDER AS SEPARATE ITEMS

0000AT0120E	Grey plastic-coated bag 73x97,5 cm, capacity 120 L, with bottom grip	1 pc.
-------------	--	-------

Suggested for 8 to 10 rooms

### ALPHA HOTEL 2300-05 - plastic trolley



REF.	PCK	VOLUME (m <sup>3</sup> )	GROSS WEIGHT (kg)	SIZE (cm)
<b>0300HA2300U05</b>	1	0,261	16,05	99x58x107

.P130001Q	Door stopper made of plastic and rubber	1 pc.
0000SM00165	Set of T-shaped light grey closing plugs for vertical frames (6 pcs)	2 pc.
P059031U	Short base with rubber wheels ø 125 mm	1 pc.
P1229900U	Set of plastic shelves (2 pcs)	1 pc.
P165000U	Base extension for Alpha trolleys and for the bag supporting plastic plate of the Morgan Hotel Elegance trolleys	1 pc.
P2039903E	Vertical frame, 1 side with slides + 1 side for T-plugs, complete with screws and plugs	2 pc.
P2199906U	Central plastic basket (female-female version) complete with caps	1 pc.
P2909921U	Closing profile with push-grip for central basket complete with screws and plugs	1 pc.
P3059953E	Fixed side wall with fixing pins	1 pc.
P8161113U	Folding 120l waste bag holder, with bag retaining hooks, dustpan hook, handle clip, screws and plugs	1 pc.

### ACCESSORIES TO ORDER AS SEPARATE ITEMS

0000AT0120E	Grey plastic-coated bag 73x97,5 cm, capacity 120 L, with bottom grip	1 pc.
-------------	--	-------

Suggested for 4 to 5 rooms



EMOTION

MORGAN HOTEL ELEGANCE

**ALPHA HOTEL**

SILVER

TROLLEYS FOR LAUNDRY COLLECTION

## ALPHA HOTEL 5300-06 - plastic trolley



## ALPHA HOTEL 5301-06 - plastic trolley



REF.	PCK	VOLUME (m <sup>3</sup> )	GROSS WEIGHT (kg)	SIZE (cm) ↓ ↓ ↓
<b>0300HA5300U06</b>	1	0,372	25,17	142x58x107
.P130001Q	Door stopper made of plastic and rubber		1 pc.	
0000SM00165	Set of T-shaped light grey closing plugs for vertical frames (6 pcs)		2 pc.	
P066031U	Long base with rubber wheels ø 125 mm		1 pc.	
P1229900U	Set of plastic shelves (2 pcs)		2 pc.	
P175000U	Supporting plastic plate for Alpha trolleys		1 pc.	
P2039903E	Vertical frame, 1 side with slides + 1 side for T-plugs, complete with screws and plugs		2 pc.	
P2039904E	Vertical frame, 2 sides with slides, complete with screws and plugs		1 pc.	
P2199906U	Central plastic basket (female-female version) complete with caps		1 pc.	
P2199907U	Central plastic basket (male-female version) complete with screws and caps		1 pc.	
P2909921U	Closing profile with push-grip for central basket complete with screws and plugs		1 pc.	
P3059953E	Fixed side wall with fixing pins		2 pc.	
P8161113U	Folding 120L waste bag holder, with bag retaining hooks, dustpan hook, handle clip, screws and plugs		1 pc.	

### ACCESSORIES TO ORDER AS SEPARATE ITEMS

0000AT0120E	Grey plastic-coated bag 73x97,5 cm, capacity 120 L, with bottom grip	1 pc.
-------------	--	-------

Suggested for 8 to 10 rooms

REF.	PCK	VOLUME (m <sup>3</sup> )	GROSS WEIGHT (kg)	SIZE (cm) ↓ ↓ ↓
<b>0500HA5301U06</b>	1	0,372	29,27	177x58x107
.P130001Q	Door stopper made of plastic and rubber		1 pc.	
0000SM00165	Set of T-shaped light grey closing plugs for vertical frames (6 pcs)		2 pc.	
P066031U	Long base with rubber wheels ø 125 mm		1 pc.	
P1229900U	Set of plastic shelves (2 pcs)		2 pc.	
P175000U	Supporting plastic plate for Alpha trolleys		2 pc.	
P2039903E	Vertical frame, 1 side with slides + 1 side for T-plugs, complete with screws and plugs		2 pc.	
P2039904E	Vertical frame, 2 sides with slides, complete with screws and plugs		1 pc.	
P2199906U	Central plastic basket (female-female version) complete with caps		1 pc.	
P2199907U	Central plastic basket (male-female version) complete with screws and caps		1 pc.	
P3059953E	Fixed side wall with fixing pins		2 pc.	
P8161113U	Folding 120L waste bag holder, with bag retaining hooks, dustpan hook, handle clip, screws and plugs		2 pc.	

### ACCESSORIES TO ORDER AS SEPARATE ITEMS

0000AT0120E	Grey plastic-coated bag 73x97,5 cm, capacity 120 L, with bottom grip	2 pc.
-------------	--	-------

Suggested for 8 to 10 rooms



EMOTION

MORGAN HOTEL ELEGANCE

**ALPHA HOTEL**

SILVER

TROLLEYS FOR LAUNDRY COLLECTION

## ALPHA HOTEL 5304-06 - plastic trolley



## ALPHA HOTEL 5302-98 - plastic trolley



REF.	PCK	VOLUME (m <sup>3</sup> )	GROSS WEIGHT (kg)	SIZE (cm) ↓ ↓ ↓
<b>0300HA5304U06</b>	1	0,372	26,7	153x58x107
P130001Q	Door stopper made of plastic and rubber		1 pc.	
0000SM00165	Set of T-shaped light grey closing plugs for vertical frames (6 pcs)		2 pc.	
P066031U	Long base with rubber wheels ø 125 mm		1 pc.	
P1191100U	Side plastic basket		2 pc.	
P1229900U	Set of plastic shelves (2 pcs)		2 pc.	
P175000U	Supporting plastic plate for Alpha trolleys		1 pc.	
P2039903E	Vertical frame, 1 side with slides + 1 side for T-plugs, complete with screws and plugs		2 pc.	
P2039904E	Vertical frame, 2 sides with slides, complete with screws and plugs		1 pc.	
P2199906U	Central plastic basket (female-female version) complete with caps		1 pc.	
P2199907U	Central plastic basket (male-female version) complete with screws and caps		1 pc.	
P2909920U	Closing profile for central basket/bag holder complete with screws and plugs		1 pc.	
P3059953E	Fixed side wall with fixing pins		2 pc.	
P8161113U	Folding 120l waste bag holder, with bag retaining hooks, dustpan hook, handle clip, screws and plugs		1 pc.	

### ACCESSORIES TO ORDER AS SEPARATE ITEMS

0000AT0120E	Grey plastic-coated bag 73x97,5 cm, capacity 120 L, with bottom grip	1 pc.
-------------	--	-------

Suggested for 8 to 10 rooms

REF.	PCK	VOLUME (m <sup>3</sup> )	GROSS WEIGHT (kg)	SIZE (cm) ↓ ↓ ↓
<b>0000HA5302U98</b>	1	0,261	18,75	97x58x107
P130001Q	Door stopper made of plastic and rubber		1 pc.	
0000SM00033E	Blocking device for side walls for Alpha trolleys		1 pc.	
0000SM00165	Set of T-shaped light grey closing plugs for vertical frames (6 pcs)		2 pc.	
P066031U	Long base with rubber wheels ø 125 mm		1 pc.	
P2039903E	Vertical frame, 1 side with slides + 1 side for T-plugs, complete with screws and plugs		2 pc.	
P2199904U	Set with 2 central basket, screws and plugs		1 pc.	
P2229911U	Plastic Shelf 46,5x79 cm		1 pc.	
P2909920U	Closing profile for central basket/bag holder complete with screws and plugs		1 pc.	
P2909921U	Closing profile with push-grip for central basket complete with screws and plugs		1 pc.	
P3059953E	Fixed side wall with fixing pins		2 pc.	

Suggested for 8 to 10 rooms

# Housekeeping trolleys



EMOTION

MORGANHOTELELEGANCE

**ALPHA HOTEL**

SILVER

TROLLEYS FOR LAUNDRY COLLECTION

## ALPHA HOTEL 5300-98 - plastic trolley



## ALPHA HOTEL 5301-98 - plastic trolley



REF.	PCK	VOLUME (m³)	GROSS WEIGHT (kg)	SIZE (cm) ↓ ↓ ↓
<b>0300HA5300U98</b>	1	0,261	21,85	142x58x107

.P130001Q	Door stopper made of plastic and rubber	1 pc.
0000SM00033E	Blocking device for side walls for Alpha trolleys	1 pc.
0000SM00165	Set of T-shaped light grey closing plugs for vertical frames (6 pcs)	2 pc.
P066031U	Long base with rubber wheels ø 125 mm	1 pc.
P175000U	Supporting plastic plate for Alpha trolleys	1 pc.
P2039903E	Vertical frame, 1 side with slides + 1 side for T-plugs, complete with screws and plugs	2 pc.
P2199904U	Set with 2 central basket, screws and plugs	1 pc.
P2229911U	Plastic Shelf 46,5x79 cm	1 pc.
P2909921U	Closing profile with push-grip for central basket complete with screws and plugs	1 pc.
P3059953E	Fixed side wall with fixing pins	2 pc.
P8161113U	Folding 120l waste bag holder, with bag retaining hooks, dustpan hook, handle clip, screws and plugs	1 pc.

### ACCESSORIES TO ORDER AS SEPARATE ITEMS

0000AT0120E	Grey plastic-coated bag 73x97,5 cm, capacity 120 L, with bottom grip	1 pc.
-------------	--	-------

Suggested for 8 to 10 rooms

REF.	PCK	VOLUME (m³)	GROSS WEIGHT (kg)	SIZE (cm) ↓ ↓ ↓
<b>0500HA5301U98</b>	1	0,372	24,97	177x58x107

.P130001Q	Door stopper made of plastic and rubber	1 pc.
0000SM00033E	Blocking device for side walls for Alpha trolleys	1 pc.
0000SM00165	Set of T-shaped light grey closing plugs for vertical frames (6 pcs)	2 pc.
P066031U	Long base with rubber wheels ø 125 mm	1 pc.
P175000U	Supporting plastic plate for Alpha trolleys	2 pc.
P2039903E	Vertical frame, 1 side with slides + 1 side for T-plugs, complete with screws and plugs	2 pc.
P2199904U	Set with 2 central basket, screws and plugs	1 pc.
P2229911U	Plastic Shelf 46,5x79 cm	1 pc.
P3059953E	Fixed side wall with fixing pins	2 pc.
P8161113U	Folding 120l waste bag holder, with bag retaining hooks, dustpan hook, handle clip, screws and plugs	2 pc.

### ACCESSORIES TO ORDER AS SEPARATE ITEMS

0000AT0120E	Grey plastic-coated bag 73x97,5 cm, capacity 120 L, with bottom grip	2 pc.
-------------	--	-------

Suggested for 8 to 10 rooms



EMOTION

MORGAN HOTEL ELEGANCE

**ALPHA HOTEL**

SILVER

TROLLEYS FOR LAUNDRY COLLECTION

## Closed version trolleys

### ALPHA HOTEL 0603002 - plastic trolley

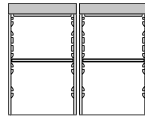

### ALPHA HOTEL 0603005 - plastic trolley

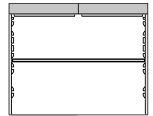

REF.	PCK	VOLUME (m <sup>3</sup> )	GROSS WEIGHT (kg)	SIZE (cm) ↓ ↓ ↓
<b>HA0603002U000</b>	1	0,372	23,01	97x58x107
.P130001Q	Door stopper made of plastic and rubber			1 pc.
0000SM00165	Set of T-shaped light grey closing plugs for vertical frames (6 pcs)			2 pc.
P066031U	Long base with rubber wheels ø 125 mm			1 pc.
P1229900U	Set of plastic shelves (2 pcs)			2 pc.
P2039903E	Vertical frame, 1 side with slides + 1 side for T-plugs, complete with screws and plugs			2 pc.
P2039904E	Vertical frame, 2 sides with slides, complete with screws and plugs			1 pc.
P2199906U	Central plastic basket (female-female version) complete with caps			1 pc.
P2199907U	Central plastic basket (male-female version) complete with screws and caps			1 pc.
P2909920U	Closing profile for central basket/bag holder complete with screws and plugs			1 pc.
P2909921U	Closing profile with push-grip for central basket complete with screws and plugs			1 pc.
P3059953E	Fixed side wall with fixing pins			2 pc.
P3059954E	Right door with fixing pins			1 pc.
P3059974E	Left door with fixing pins			1 pc.

Suggested for 8 to 10 rooms

REF.	PCK	VOLUME (m <sup>3</sup> )	GROSS WEIGHT (kg)	SIZE (cm) ↓ ↓ ↓
<b>HA0603005U000</b>	1	0,31	26,99	97x58x107
.P130001Q	Door stopper made of plastic and rubber			1 pc.
0000SM00033E	Blocking device for side walls for Alpha trolleys			1 pc.
0000SM00165	Set of T-shaped light grey closing plugs for vertical frames (6 pcs)			2 pc.
P066031U	Long base with rubber wheels ø 125 mm			1 pc.
P2039903E	Vertical frame, 1 side with slides + 1 side for T-plugs, complete with screws and plugs			2 pc.
P2229911U	Plastic Shelf 46,5x79 cm			1 pc.
P2909920U	Closing profile for central basket/bag holder complete with screws and plugs			1 pc.
P2909921U	Closing profile with push-grip for central basket complete with screws and plugs			1 pc.
P3059953E	Fixed side wall with fixing pins			2 pc.
P3059977E	Right and left wing door set for Alpha trolleys			1 pc.
P3199908U	Set of 2 central upper baskets with swing door support, screws and plugs			1 pc.

Suggested for 8 to 10 rooms



# Housekeeping trolleys



EMOTION

MORGAN HOTEL ELEGANCE

**ALPHA HOTEL**

SILVER

TROLLEYS FOR LAUNDRY COLLECTION

## ALPHA HOTEL 3300-05 - plastic trolley



## ALPHA HOTEL 0603003 - plastic trolley

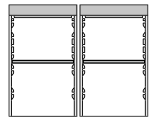

REF.	PCK	VOLUME (m <sup>3</sup> )	GROSS WEIGHT (kg)	SIZE (cm)
<b>0300HA3300U05</b>	1	0,261	21,15	99x58x107

.P130001Q	Door stopper made of plastic and rubber	1 pc.
0000SM00165	Set of T-shaped light grey closing plugs for vertical frames (6 pcs)	2 pc.
P059031U	Short base with rubber wheels ø 125 mm	1 pc.
P1229900U	Set of plastic shelves (2 pcs)	1 pc.
P165000U	Base extension for Alpha trolleys and for the bag supporting plastic plate of the Morgan Hotel Elegance trolleys	1 pc.
P2039903E	Vertical frame, 1 side with slides + 1 side for T-plugs, complete with screws and plugs	2 pc.
P2199906U	Central plastic basket (female-female version) complete with caps	1 pc.
P2909921U	Closing profile with push-grip for central basket complete with screws and plugs	1 pc.
P3059953E	Fixed side wall with fixing pins	1 pc.
P3059954E	Right door with fixing pins	1 pc.
P8161113U	Folding 120l waste bag holder, with bag retaining hooks, dustpan hook, handle clip, screws and plugs	1 pc.

### ACCESSORIES TO ORDER AS SEPARATE ITEMS

0000AT0120E	Grey plastic-coated bag 73x97,5 cm, capacity 120 L, with bottom grip	1 pc.
-------------	--	-------

Suggested for 4 to 5 rooms

REF.	PCK	VOLUME (m <sup>3</sup> )	GROSS WEIGHT (kg)	SIZE (cm)
<b>HA0603003U000</b>	1	0,372	27,17	142x58x107

.P130001Q	Door stopper made of plastic and rubber	1 pc.
0000SM00165	Set of T-shaped light grey closing plugs for vertical frames (6 pcs)	2 pc.
P066031U	Long base with rubber wheels ø 125 mm	1 pc.
P1229900U	Set of plastic shelves (2 pcs)	2 pc.
P175000U	Supporting plastic plate for Alpha trolleys	1 pc.
P2039903E	Vertical frame, 1 side with slides + 1 side for T-plugs, complete with screws and plugs	2 pc.
P2039904E	Vertical frame, 2 sides with slides, complete with screws and plugs	1 pc.
P2199906U	Central plastic basket (female-female version) complete with caps	1 pc.
P2199907U	Central plastic basket (male-female version) complete with screws and caps	1 pc.
P2909921U	Closing profile with push-grip for central basket complete with screws and plugs	1 pc.
P3059953E	Fixed side wall with fixing pins	2 pc.
P3059954E	Right door with fixing pins	1 pc.
P3059974E	Left door with fixing pins	1 pc.
P8161113U	Folding 120l waste bag holder, with bag retaining hooks, dustpan hook, handle clip, screws and plugs	1 pc.

### ACCESSORIES TO ORDER AS SEPARATE ITEMS

0000AT0120E	Grey plastic-coated bag 73x97,5 cm, capacity 120 L, with bottom grip	1 pc.
-------------	--	-------

Suggested for 8 to 10 rooms



EMOTION

MORGAN HOTEL ELEGANCE

**ALPHA HOTEL**

SILVER

TROLLEYS FOR LAUNDRY COLLECTION

## ALPHA HOTEL 0603004 - plastic trolley

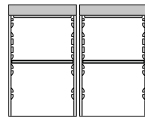

REF.	PCK	VOLUME (m³)	GROSS WEIGHT (kg)	SIZE (cm)
<b>HA0603004U000</b>	1	0,372	31,67	177x58x107

.P130001Q	Door stopper made of plastic and rubber	1 pc.
0000SM00165	Set of T-shaped light grey closing plugs for vertical frames (6 pcs)	2 pc.
P066031U	Long base with rubber wheels ø 125 mm	1 pc.
P1229900U	Set of plastic shelves (2 pcs)	2 pc.
P175000U	Supporting plastic plate for Alpha trolleys	2 pc.
P2039903E	Vertical frame, 1 side with slides + 1 side for T-plugs, complete with screws and plugs	2 pc.
P2039904E	Vertical frame, 2 sides with slides, complete with screws and plugs	1 pc.
P2199906U	Central plastic basket (female-female version) complete with caps	1 pc.
P2199907U	Central plastic basket (male-female version) complete with screws and caps	1 pc.
P3059953E	Fixed side wall with fixing pins	2 pc.
P3059954E	Right door with fixing pins	1 pc.
P3059974E	Left door with fixing pins	1 pc.
P8161113U	Folding 120l waste bag holder, with bag retaining hooks, dustpan hook, handle clip, screws and plugs	2 pc.

### ACCESSORIES TO ORDER AS SEPARATE ITEMS

0000AT0120E	Grey plastic-coated bag 73x97,5 cm, capacity 120 L, with bottom grip	2 pc.
-------------	--	-------

Suggested for 8 to 10 rooms



EMOTION

MORGAN HOTEL ELEGANCE

**ALPHA HOTEL**

SILVER

TROLLEYS FOR LAUNDRY COLLECTION

## Components and accessories for Alpha Hotel trolleys

### Short plastic base for Alpha trolley



REF.	NOTES	SIZE (cm) ↓ ↓ ↓
<b>P059011U</b>	with wheels ø 100 mm	66x52
<b>P059031U</b>	with rubber wheels ø 125 mm	66x52
<b>P059061U</b>	with wheels ø 125 mm	66x52

### Long plastic base for Alpha trolley



REF.	NOTES	SIZE (cm) ↓ ↓ ↓
<b>P066011U</b>	with wheels ø 100 mm	91x52
<b>P066031U</b>	with rubber wheels ø 125 mm	91x52
<b>P066061U</b>	with wheels ø 125 mm	91x52

### Base extension for Alpha trolleys and for the bag supporting plastic plate of the Morgan Hotel Elegance trolleys



REF.	NOTES	SIZE (cm) ↓ ↓ ↓
<b>P165000U</b>		48x22x15

### Supporting plastic plate for Alpha trolleys

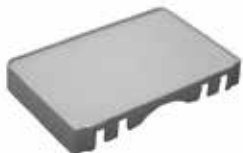

REF.	NOTES	SIZE (cm) ↓ ↓ ↓
<b>P175000U</b>		48x32x7

### Vertical frame, 1 side with slides + 1 side for T-plugs, complete with screws and plugs



REF.	NOTES
<b>P2039903E</b>	

### Vertical frame, 2 sides with slides, complete with screws and plugs

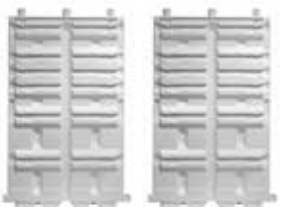

REF.	NOTES
<b>P2039904E</b>	



EMOTION

MORGAN HOTEL ELEGANCE

**ALPHA HOTEL**

SILVER

TROLLEYS FOR LAUNDRY COLLECTION

Quick connection kit Link-Up to fix Alpha vertical frames



REF.	NOTES
0000SM00617	

Set of T-shaped closing plugs for vertical frames (6 pcs)



REF.	NOTES
0000SM00163	dark grey
0000SM00165	light grey

Fixed side wall with fixing pins



REF.	NOTES
P3059953E	

Right door with fixing pins



REF.	NOTES
P3059954E	

Left door with fixing pins



REF.	NOTES
P3059974E	

Right and left wing door set for Apha trolleys



REF.	NOTES
P3059977E	

# Housekeeping trolleys



EMOTION

MORGAN HOTEL ELEGANCE

**ALPHA HOTEL**

SILVER

TROLLEYS FOR LAUNDRY COLLECTION

## Central plastic basket (female-female version) complete with caps



REF.	NOTES
<b>P2199906U</b>	internal dimension 48x31x8 cm

## Central plastic basket (male-female version) complete with screws and caps



REF.	NOTES
<b>P2199907U</b>	internal dimension 48x31x8 cm

## Set of 2 central upper baskets with swing door support, screws and plugs



REF.	NOTES
<b>P3199908U</b>	

## Set with 2 central basket, screws and plugs



REF.	NOTES
<b>P2199904U</b>	

## Side plastic basket



REF.	NOTES
<b>P1191100U</b>	external dimension 49x22x11,5 cm

## Closing profile with push-grip for central basket complete with screws and plugs



REF.	NOTES
<b>P2909921U</b>	

## Folding 120l waste bag holder, with bag retaining hooks, 2 fixed dustpan hooks, 1 handle clip, 2 Uni-Move clips, screws and plugs



REF.	NOTES
<b>P8161113U</b>	
<b>P8161115U</b>	for trolleys with central frame



EMOTION

MORGAN HOTEL ELEGANCE

**ALPHA HOTEL**

SILVER

TROLLEYS FOR LAUNDRY COLLECTION

Bumper set for 120-litre bag holder (no. 1 right bumper + no. 1 left bumper)



REF.	NOTES
000SM00260	

Set of plastic shelves (2 pcs)

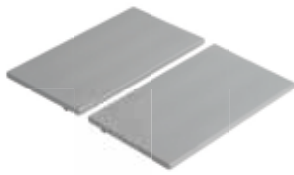

REF.	NOTES	SIZE (cm)
P1229900U		21,5x37,5x1,5

Plastic Shelf 46,5x79 cm



REF.	NOTES
P2229911U	

Plastic cover for bag holder 120 L with storage room, check-list holder and lock

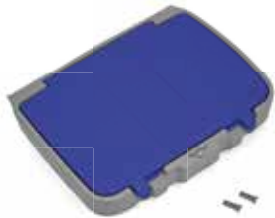

REF.	NOTES
P291920UA	
P291920UB	
P291920U	



Please, require also no. 2 shock absorbing pistons art. P190908U for a perfect soft closing

Shock absorbing piston for a soft closing of the cover



REF.	NOTES
P190908U	



Lithium battery for Drive trolleys

**NEW**



REF.	NOTES
00BL1000	

# Housekeeping trolleys



EMOTION

MORGAN HOTELELEGANCE

ALPHAHOTEL

**SILVER**

TROLLEYS FOR LAUNDRY COLLECTION



**Silver** trolleys are practical and handy service trolleys, ideal for hotels, restaurants, company canteens and fast-food chains.

Silver is also available in the **panelled version**:

- **Higher capacity and safer:** thanks to the plastic closing walls storage possibilities and stability during transportation are surely improved, thus offering an even more efficient service
- **Smarter and more versatile:** its neat and modern design with two colour options makes it suitable for all environments
- **More hygienic and ergonomic:** thanks to its smooth surfaces with rounded up corners it can be easily cleaned and thanks to its ergonomic push-bars it can be easily handled
- **Stronger:** Silver is handy and very strong as it is manufactured with aluminium vertical frames and plastic shelves/walls (up to 50 kg per each shelf)
- **More silent:** it is available also with rubber wheels  $\varnothing$  125 mm, highly sliding and silent, with bumpers



Versions closed by plastic panels, available in two colours



Available also with rubber wheels  $\varnothing$  125 mm and with shock-absorbing bumpers



Ergonomic, rounded shape and plastic push-bar



## Silver trolleys

**SILVER 1200** - service trolley with aluminium vertical frames, 2 shelves and wheels  $\varnothing$  100x28 mm

**SILVER 1300** - service trolley with aluminium vertical frames, 3 shelves and wheels  $\varnothing$  100x28 mm



REF.	PCK	VOLUME (m <sup>3</sup> )	GROSS WEIGHT (kg)	SIZE (cm) ↓ ↓ ↓
0000SP1200D	<input type="checkbox"/>	1	0,127	15,28
0000SP1200E	<input checked="" type="checkbox"/>	1	0,127	15,28

Maximum load capacity of each shelf: 50 kg

REF.	PCK	VOLUME (m <sup>3</sup> )	GROSS WEIGHT (kg)	SIZE (cm) ↓ ↓ ↓
0000SP1300D	<input type="checkbox"/>	1	0,163	16,76
0000SP1300E	<input checked="" type="checkbox"/>	1	0,163	16,76

Maximum load capacity of each shelf: 50 kg



EMOTION

MORGAN HOTEL ELEGANCE

ALPHA HOTEL

**SILVER**

TROLLEYS FOR LAUNDRY COLLECTION

**SILVER 1310** - service trolley with plastical vertical frames, 3 shelves and wheels  $\varnothing$  100x28 mm



**SILVER 1300-16** - trolley with aluminium vertical frames, 3 shelves, rubber wheels  $\varnothing$  125 mm and bumpers  $\varnothing$  130 mm



REF.	PCK	VOLUME (m <sup>3</sup> )	GROSS WEIGHT (kg)	SIZE (cm) ↓ ↓ ↓
0000SP1310D	1	0,163	16,24	111x50x97
0000SP1310E	1	0,163	16,24	111x50x97

Maximum load capacity of each shelf: 50 kg

REF.	PCK	VOLUME (m <sup>3</sup> )	GROSS WEIGHT (kg)	SIZE (cm) ↓ ↓ ↓
0000SP1300D16	1	0,163	17,29	111x58x104
0000SP1300E16	1	0,163	17,29	111x58x104

Maximum load capacity of each shelf: 50 kg

**SILVER 1301** - service trolley with aluminium vertical frames, 3 shelves and wheels  $\varnothing$  100x28 mm and closing walls



**SILVER 1301-16** - trolley with aluminium vertical frames, 3 shelves, rubber wheels  $\varnothing$  125 mm, bumpers  $\varnothing$  130 mm and closing walls



REF.	PCK	VOLUME (m <sup>3</sup> )	GROSS WEIGHT (kg)	SIZE (cm) ↓ ↓ ↓
0000SP1301D	1	0,193	20,75	111x50x100
0000SP1301E	1	0,193	20,75	111x50x100

Maximum load capacity of each shelf: 50 kg

REF.	PCK	VOLUME (m <sup>3</sup> )	GROSS WEIGHT (kg)	SIZE (cm) ↓ ↓ ↓
0000SP1301D16	1	0,193	21,48	111x58x107
0000SP1301E16	1	0,193	21,48	111x58x107

Maximum load capacity of each shelf: 50 kg





EMOTION

MORGAN HOTEL ELEGANCE

ALPHA HOTEL

**SILVER**

TROLLEYS FOR LAUNDRY COLLECTION

## Silver shelves

**SILVER 2410** - trolley with 4 shelves, plastic vertical frames and plastic feet



**SILVER 2510** - trolley with 5 shelves, plastic vertical frames and plastic feet



REF.	PCK	VOLUME (m <sup>3</sup> )	GROSS WEIGHT (kg)	SIZE (cm) ↓ ↓ ↓
0000SP2410E	1	0,232	18,71	90x50x127

Maximum load capacity of each shelf: 40 kg

REF.	PCK	VOLUME (m <sup>3</sup> )	GROSS WEIGHT (kg)	SIZE (cm) ↓ ↓ ↓
0000SP2510E	1	0,277	22,21	90x50x163

Maximum load capacity of each shelf: 40 kg

## Components and accessories for Silver trolleys

### Plastic base for Silver trolley



REF.	NOTES	SIZE (cm) ↓ ↓ ↓
P104001D	for Silver trolley with wheels	89x49
P104001E	for Silver trolley with wheels	89x49

### Central plastic shelf for Silver trolley



REF.	NOTES	SIZE (cm) ↓ ↓ ↓
P104002D	for Silver trolley with wheels	89x49
P104002E		89x49

### Top plastic shelf for Silver trolley



REF.	NOTES	SIZE (cm) ↓ ↓ ↓
P104003D	For Silver trolley with push-bar	89x49
P104003E	For Silver trolley with push-bar	89x49

### Kit for closing the lower part of Silver trolleys



REF.	NOTES
0000SM00244D	
0000SM00244E	



EMOTION

MORGAN HOTEL ELEGANCE

ALPHA HOTEL

**SILVER**

TROLLEYS FOR LAUNDRY COLLECTION

## Kit for closing the upper part of Silver trolleys



REF.	NOTES
0000SM00245D	
0000SM00245E	

## Plastic push-bar for Silver trolley



REF.	NOTES
P179080U	

## Plastic vertical frame 29,6 cm for Silver trolleys with 3 shelves



REF.	NOTES
PA50028D	

## Aluminium vertical frame for Silver trolley



REF.	NOTES	SIZE (cm) ↓ ↓ ↓
TA50029	for Silver with 3 shelves	29,6
TA50066	for Silver with 2 shelves	66

## Plastic bin 25 L for Silver trolley



REF.	NOTES	PCK	VOLUME (m³)	GROSS WEIGHT (kg)
8269/1		4	0,095	4,73

# Housekeeping trolleys



EMOTION

MORGANHOTELELEGANCE

ALPHAHOTEL

SILVER

**TROLLEYS FOR LAUNDRY COLLECTION**

**Trolleys for laundry collection** are mainly used for the transport of dirty laundry in hospitals and communities. They have a Rilsan coated structure and a strong plastic base very useful in case of heavy bags.

Available also **in the version with Rilsan coated push-bar** for a better handling and transportation of the trolley.



Can be available with **Hush System** for a **slow closing of the cover** thanks to two pistons which ensure the highest silence.



## Trolleys for laundry collection with pedal and cover

Rilsan coated trolley for laundry collection 70 L with push-grip, pedal, cover, elastic and pirouetting wheels ø 80 mm

**NEW**



REF.	NOTES	PCK	VOLUME (m³)	GROSS WEIGHT (kg)	SIZE (cm) ↓ ↓ ↓
R9276		1	0,22	8,27	48x48,2x97

**ON REQUEST, WITH SURCHARGE**



Pistons kit for soft-close lid

TROLLEY REF.  
R4276

Rilsan coated trolley for laundry collection 70 L complete with pedal, cover, elastic and pirouetting wheels ø 80 mm

**NEW**



REF.	NOTES	PCK	VOLUME (m³)	GROSS WEIGHT (kg)	SIZE (cm) ↓ ↓ ↓
R9176		1	0,215	7,21	39,2x48,2x95

**ON REQUEST, WITH SURCHARGE**



Pistons kit for soft-close lid

TROLLEY REF.  
R4176

HOUSEKEEPING TROLLEYS



EMOTION

MORGAN HOTEL ELEGANCE

ALPHA HOTEL

SILVER

**TROLLEYS FOR LAUNDRY COLLECTION**

Rilsan coated trolley for laundry collection 2x70 L with push-grip complete with pedal, covers, elastics and pirouetting wheels ø 80 mm

**NEW**



REF.	NOTES	PCK	VOLUME (m³)	GROSS WEIGHT (kg)	SIZE (cm) ↓ ↓ ↓
R9277		1	0,27	14,42	89x48,2x97

**ON REQUEST, WITH SURCHARGE**



Pistons kit for soft-close lid

TROLLEY REF.  
R4277

Rilsan coated trolley for laundry collection 2x70 L complete with pedals, covers, elastics and pirouetting wheels ø 80 mm

**NEW**



REF.	NOTES	PCK	VOLUME (m³)	GROSS WEIGHT (kg)	SIZE (cm) ↓ ↓ ↓
R9177		1	0,215	11,71	74,5x48,2x95

**ON REQUEST, WITH SURCHARGE**



Pistons kit for soft-close lid

TROLLEY REF.  
R4177

Rilsan coated trolley for laundry collection 3x70 L complete with pedals, covers, elastics and pirouetting wheels ø 80 mm

**NEW**



REF.	NOTES	PCK	VOLUME (m³)	GROSS WEIGHT (kg)	SIZE (cm) ↓ ↓ ↓
R9178		1	0,27	16,97	110x48,2x95

**ON REQUEST, WITH SURCHARGE**



Pistons kit for soft-close lid

TROLLEY REF.  
R4178

Rilsan coated trolley for laundry collection 4x70 L complete with pedals, covers, elastics and pirouetting wheels ø 80 mm

**NEW**



REF.	NOTES	PCK	VOLUME (m³)	GROSS WEIGHT (kg)	SIZE (cm) ↓ ↓ ↓
R9179		1	0,31	21,49	146x48,2x95

**ON REQUEST, WITH SURCHARGE**



Pistons kit for soft-close lid

TROLLEY REF.  
R4179

## Trolleys for laundry collection with cover

Rilsan coated trolley for laundry collection 70 L with push-grip, cover, elastic and pirouetting wheels ø 80 mm

**NEW**



REF.	NOTES	PCK	VOLUME (m³)	GROSS WEIGHT (kg)	SIZE (cm) ↓ ↓ ↓
R9266		1	0,22	1,8	48x48,2x97

**ON REQUEST, WITH SURCHARGE**



Pistons kit for soft-close lid

TROLLEY REF.  
R4266

# Housekeeping trolleys



EMOTION

MORGAN HOTEL ELEGANCE

ALPHA HOTEL

SILVER

**TROLLEYS FOR LAUNDRY COLLECTION**

Rilsan coated trolley for laundry collection 70 L complete with cover, elastic and pirouetting wheels ø 80 mm

**NEW**



REF.	NOTES	PCK	VOLUME (m³)	GROSS WEIGHT (kg)	SIZE (cm) ↓ ↓ ↓
<b>R9166</b>		1	0,215	6,8	39,2x48,2x95

**ON REQUEST, WITH SURCHARGE**



Pistons kit for soft-close lid

**TROLLEY REF. R4166**

Rilsan coated trolley for laundry collection 2x70 L with push-grip, covers, elastics and pirouetting wheels ø 80 mm

**NEW**



REF.	NOTES	PCK	VOLUME (m³)	GROSS WEIGHT (kg)	SIZE (cm) ↓ ↓ ↓
<b>R9267</b>		1	0,27	13,69	89x48,2x97

**ON REQUEST, WITH SURCHARGE**



Pistons kit for soft-close lid

**TROLLEY REF. R4267**

Rilsan coated trolley for laundry collection 2x70 L complete with covers, elastics and pirouetting wheels ø 80 mm

**NEW**



REF.	NOTES	PCK	VOLUME (m³)	GROSS WEIGHT (kg)	SIZE (cm) ↓ ↓ ↓
<b>R9167</b>		1	0,215	10,89	74,5x48,2x95

**ON REQUEST, WITH SURCHARGE**



Pistons kit for soft-close lid

**TROLLEY REF. R4167**

Rilsan coated trolley for laundry collection 3x70 L complete with covers, elastics and pirouetting wheels ø 80 mm

**NEW**



REF.	NOTES	PCK	VOLUME (m³)	GROSS WEIGHT (kg)	SIZE (cm) ↓ ↓ ↓
<b>R9168</b>		1	0,27	15,74	110x48,2x95

**ON REQUEST, WITH SURCHARGE**



Pistons kit for soft-close lid

**TROLLEY REF. R4168**

Rilsan coated trolley for laundry collection 4x70 L complete with covers, elastics and pirouetting wheels ø 80 mm

**NEW**



REF.	NOTES	PCK	VOLUME (m³)	GROSS WEIGHT (kg)	SIZE (cm) ↓ ↓ ↓
<b>R9169</b>		1	0,31	19,85	146x48,2x95

**ON REQUEST, WITH SURCHARGE**



Pistons kit for soft-close lid

**TROLLEY REF. R4169**



EMOTION

MORGANHOTELELEGANCE

ALPHAHOTEL

SILVER

**TROLLEYS FOR LAUNDRY COLLECTION**

## Trolleys for laundry collection without cover and pedal

Rilsan coated trolley for laundry collection 70 L with push-grip, elastic and pirouetting wheels ø 80 mm



REF.	NOTES	PCK	VOLUME (m³)	GROSS WEIGHT (kg)	SIZE (cm) ↓ ↓ ↓
<b>R9256</b>		1	0,22	7	48x48,2x97

Rilsan coated trolley for laundry collection 70 L complete with elastic and pirouetting wheels ø 80 mm



REF.	NOTES	PCK	VOLUME (m³)	GROSS WEIGHT (kg)	SIZE (cm) ↓ ↓ ↓
<b>R9156</b>		1	0,215	6,3	39,2x48,2x95

Rilsan coated trolley for laundry collection 70 L with push-grip, elastics and pirouetting wheels ø 80 mm



REF.	NOTES	PCK	VOLUME (m³)	GROSS WEIGHT (kg)	SIZE (cm) ↓ ↓ ↓
<b>R9257</b>		1	0,27	12,47	89x48,2x97

Rilsan coated trolley for laundry collection 2x70 L complete with elastics and pirouetting wheels ø 80 mm



REF.	NOTES	PCK	VOLUME (m³)	GROSS WEIGHT (kg)	SIZE (cm) ↓ ↓ ↓
<b>R9157</b>		1	0,215	9,89	74,5x48,2x95

Rilsan coated trolley for laundry collection 3x70 L complete with elastics and pirouetting wheels ø 80 mm



REF.	NOTES	PCK	VOLUME (m³)	GROSS WEIGHT (kg)	SIZE (cm) ↓ ↓ ↓
<b>R9158</b>		1	0,27	14,24	110x48,2x95

# Housekeeping trolleys



EMOTION

MORGANHOTELELEGANCE

ALPHAHOTEL

SILVER

**TROLLEYS FOR LAUNDRY COLLECTION**

Rilsan coated trolley for laundry collection 4x70 L complete with elastics and pirouetting wheels ø 80 mm



REF.	NOTES	PCK	VOLUME (m³)	GROSS WEIGHT (kg)	SIZE (cm) ↓ ↓ ↓
<b>R9159</b>		1	0,31	17,85	146x48,2x95

## "X" trolley for laundry collection

Chromed X-trolley for laundry collection, plastified bag and pirouetting wheels ø 80 mm



REF.	NOTES	PCK	VOLUME (m³)	GROSS WEIGHT (kg)	SIZE (cm) ↓ ↓ ↓
<b>8043</b>	with 4 hooks and bag 150 L	5	0,302	34,68	62x60x103
<b>8044</b>	with 6 hooks and bag 180 L	2	0,21	18,79	62x70x103

## Components and accessories for laundry collection trolleys

Supporting plastic plate for laundry trolleys art. R9176, R9177, R9178 and R9179



REF.	NOTES
<b>P114021U</b>	

Plastic pedal for laundry trolleys art. R9176, R9177, R9178 and R9179



REF.	NOTES
<b>P190928U</b>	

Stainless steel back rod connecting pedal/cover ø 5,8 mm, lenght 76 cm for laundry trolleys art. R9176, R9177, R9178 e R9179



REF.	NOTES
<b>I1900011</b>	

Plastic plug to fix back rod connecting pedal/cover for laundry trolleys art. R9176, R9177, R9178 and R9179



REF.	NOTES
<b>P190927U</b>	



EMOTION

MORGAN HOTEL ELEGANCE

ALPHA HOTEL

SILVER

**TROLLEYS FOR LAUNDRY COLLECTION**

Double fixing device with snap closure for laundry trolleys art. R9176, R9177, R9178 and R9179



REF.	NOTES
8229U	

Plastic cover for laundry trolleys art. R9176, R9177, R9178 and R9179



REF.	NOTES
P290929A	
P290929B	
P290929C	
P290929F	

White polyester bag with strings and button, with open side and coloured stripe, for laundry collection trolleys



REF.	NOTES	SIZE (cm) ↓ ↓ ↓
8181A	with blue stripe	54x101
8181B	with red stripe	54x101
8181C	with yellow stripe	54x101
8181F	with green stripe	54x101

White polyester bag with strings and button, completely closed, for laundry collection trolleys



REF.	NOTES	SIZE (cm) ↓ ↓ ↓
8182A	with blue stripe	81x101
8182B	with red stripe	81x101
8182C	with yellow stripe	81x101
8182F	with green stripe	81x101

Bag fixing elastic



REF.	NOTES
8054	for trolleys art. 8045, 8070, 8075, 8076, 8077, 8077/1 and R8377
8054/1	for Trend and laundry trolleys

Plastified bag for "X" laundry collection trolley



REF.	NOTES	CAPACITY (L)	SIZE (cm) ↓ ↓ ↓
8052	for art. 8043	150	46x32x90
8052/1	for art. 8044	180	53x92x82

Pistons kit for soft-close lid on laundry trolleys



REF.	NOTES
000SM00640	

**NEW**





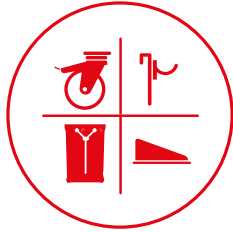

## Accessories for trolleys

- Carry baskets
- Paper holders for paper rolls
- Quivers
- Door stoppers
- Hoses for bucket filling
- Note boards
- Hooks
- Bags
- Wheels



**CARRY BASKETS**

PAPER HOLDERS FOR PAPER ROLLS

QUIVERS

DOOR STOPPERS

HOSES FOR BUCKET FILLING

NOTE BOARDS

HOOKS

BAGS

WHEELS

Filmop **carry baskets** are handy and useful for the transport of bottles and small cleaning tools. They can be equipped with bottle holders and dividers for a better organization of the content.



## Carry baskets with grip

Plastic carry basket with special shaped bottle holder, 2 compartments and fixed grip



REF.	NOTES	SIZE (cm) ↓ ↓ ↓
<b>3690U</b>		33,5x28,3x26

Plastic carry basket with special shaped bottle holder, 2 compartments and grip



REF.	NOTES	SIZE (cm) ↓ ↓ ↓
<b>3691U</b>		32,5x25x31

Plastic carry basket complete with 3 dividers and grip



REF.	NOTES	SIZE (cm) ↓ ↓ ↓
<b>3669U</b>		32,5x25x31

Plastic carry basket with 3 compartments and grip



REF.	NOTES	SIZE (cm) ↓ ↓ ↓
<b>3635U</b>		40x29x17

## Accessories for carry baskets

Side plastic basket with 3 compartments fitting basket art. 3690U



REF.	NOTES	SIZE (cm) ↓ ↓ ↓
<b>60405U</b>		17x28,3x14



# Accessories for trolleys



## CARRY BASKETS

PAPER HOLDERS FOR PAPER ROLLS

QUIVERS

DOOR STOPPERS

HOSES FOR BUCKET FILLING

NOTE BOARDS

HOOKS

BAGS

WHEELS

Plastic bottle holder with 3 shaped holes for baskets art. 3691U and 3690U



REF.	NOTES	SIZE (cm)
<b>60404U</b>		↓ ↓ ↓ 32x12,2x4

Divider for plastic basket art. 3669U



REF.	NOTES
<b>P1909940U</b>	

Rilsan coated holder for carry basket art. 3690U



REF.	NOTES
<b>R2240040</b>	fitting Morgan Hotel trolleys

Rilsan coated holder for carry basket art. 3635U



REF.	NOTES
<b>R2240030</b>	fitting Morgan Hotel trolleys

## Baskets with dividers

Plastic basket complete with 3 dividers



REF.	NOTES
<b>P2191101U</b>	1. suitable for the closing profile and bag holder 120 L of Alpha trolleys
<b>P2191103U</b>	1. for mounting on Alpha trolley finishing trim and 120l bag holder - with long fittings
<b>P2191102U</b>	2. suitable for the vertical frames of Alpha trolleys
<b>P219007U</b>	3. suitable for the vertical frame of Morgan trolley art. 0000MP3080A



## Carry baskets with support

Plastic carry basket



REF.	NOTES	SIZE (cm)
<b>60402A</b>		↓ ↓ ↓ 32x13x14

## Plastic support for basket

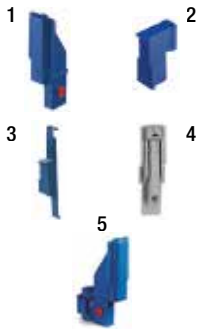

REF.	NOTES
P290800A	1. for Orion-Fred trolleys frame
P179002A	2. for bag holder art. P206002A of Vega trolley
P179001A	3. for Maxi Jolly single bucket
P1901113U	4. for vertical frame of Alpha trolleys
0000SM00126	5. for vertical frames ø 22 mm



## Vertical paper holder

### Vertical plastic paper holder



REF.	NOTES
P225001A	for Vega trolleys
P225005U	for Morgan trolleys

## Paper holder with cover

### Set of plastic paper holder with cover complete with 3 hooks



REF.	NOTES
P225004A	

### Plastic paper holder

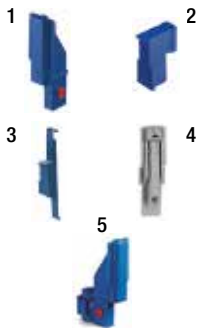

REF.	NOTES
P290800A	1. for Orion-Fred trolleys frame
P179002A	2. for bag holder art. P206002A of Vega trolley
P179001A	3. for Maxi Jolly single bucket
P1901113U	4. for vertical frame of Alpha trolleys
0000SM00126	5. for vertical frames ø 22 mm



### Rilsan coated support for paper holder complete with hooks, fitting closing profile of Alpha trolleys



REF.	NOTES
R2030154	



CARRY BASKETS

PAPER HOLDERS  
FOR PAPER ROLLS

**QUIVERS**

DOOR STOPPERS

HOSES FOR  
BUCKET FILLING

NOTE BOARDS

HOOKS

BAGS

WHEELS

## ■ Plastic quivers

### Plastic quiver for polybags



REF.	NOTES
P120007A	

### Plastic quiver for window squeegees, washers, scrapers



REF.	NOTES
P120008A	

### Plastic support for quivers

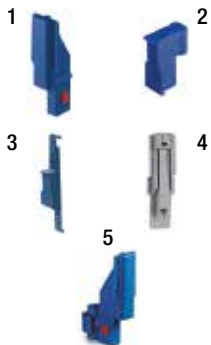

REF.	NOTES
P290800A	1. for Orion-Fred trolleys frame
P179002A	2. for bag holder art. P206002A of Vega trolley
P179001A	3. for Maxi Jolly single bucket
P1901113U	4. for vertical frame of Alpha trolleys
0000SM00126	5. for vertical frames ø 22 mm



CARRY BASKETS

PAPER HOLDERS  
FOR PAPER ROLLS

QUIVERS

**DOOR STOPPERS**

HOSES FOR  
BUCKET FILLING

NOTE BOARDS

HOOKS

BAGS

WHEELS

Filmop proposes the new **door stopper with handle** as an useful accessory for the cleaning operations.

- **Universal:** fitting any kind of door
- **Non-slip:** the shaped rubber profile grants a good holding
- **Ergonomic:** innovative patented system to block and unblock the door stopper's handle easily and without a continuous bending
- **Safer:** it eliminates the continuous operations of door opening and closure
- **Non-marking:** the rubber profile protects the surface of doors and floors
- **Handy:** it can be easily hung to the cleaning trolley and carried



## ■ Universal door stoppers

Door stopper made of plastic and rubber

REF.	NOTES	PCK	VOLUME (m <sup>3</sup> )	GROSS WEIGHT (kg)	SIZE (cm) ↓ ↓ ↓
<b>P130001Q</b>		50	0,028	3,18	7,9x15x5



Door stopper made of plastic and rubber with handle 70 cm

REF.	NOTES	PCK	VOLUME (m <sup>3</sup> )	GROSS WEIGHT (kg)	SIZE (cm) ↓ ↓ ↓
<b>P230001Q</b>		6	0,014	1,77	7,9x15,7x74,5





CARRY BASKETS

PAPER HOLDERS  
FOR PAPER ROLLS

QUIVERS

DOOR STOPPERS

**HOSES FOR  
BUCKET FILLING**

**NOTE BOARDS**

HOOKS

BAGS

WHEELS

## Hoses

Hose for bucket filling 110 cm



REF.	NOTES
P190010E	

Hose for bucket filling 150 cm



REF.	NOTES
P190020U	

Universal hose connection fitting all types of taps

## Boards

Plastic board

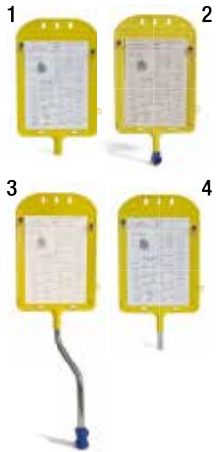

REF.	NOTES
P299001C	1. suitable for vertical paper holder art. P225001A
0000PA0101C	2. suitable for tubes $\varnothing$ 22 mm
0000PA0104C	2. suitable for tubes $\varnothing$ 22 mm
0000PA0102C	4. suitable for the profile of Alpha trolleys



## Uni-Move: universal handle hook

### An universal handle holder for any type of handle!



Uni-Move is the handle holder by Filmop to **hang quickly and easily any type of handle** to the service trolley.

Thanks to its **special flexible structure**, Uni-Move **can be fixed in few seconds** to any tool, regardless of its shape or size.

### UNIVERSAL

Thanks to its original and innovating design with a flexible rubber part, it is compatible with handles of several diameters (from 21 mm to 29 mm).



### TWO MATERIALS COMBINED TOGETHER AND RESISTANT

Made of plastic and extensible, shock-absorbing and non-slip rubber, all in one mould.



### FAST

It can be fixed and removed in just a few seconds.



## Uni-Move handle holder

### UNI-MOVE - universal plastic handle holder



REF.	NOTES
0000SM00250U	

### Plastic support for Uni-Move hook with sign holder



REF.	NOTES
P1919969U	short - fitting the central frame with cover of Alpha trolleys
P1929969U	long - fitting the bag holder 150 L and profile of Alpha trolleys

### Holder for Uni-Move handle holder



REF.	NOTES
P1909901U	







CARRY BASKETS

PAPER HOLDERS  
FOR PAPER ROLLS

QUIVERS

DOOR STOPPERS

HOSES FOR  
BUCKET FILLING

NOTE BOARDS

**HOOKS**

BAGS

WHEELS

## Handle holders

### Plastic handle holder



REF.	NOTES
0000SM00100U	1. for basket art. 60402A and bucket holder art. P220001E for Vega-Arka trolleys
0000SM00129U	2. fitting push-bar art. 7964A-7966A for Orion-Vega-Arka trolleys
60072U	3. for Delta bag holder - Alpha bag holder and closing profile
0000SM00122U	4. for Alpha and Morgan side basket
0000SM00206U	5. for Alpha central basket
8214U	6. turning, with screws for tubes $\varnothing$ 22 mm
8223U	6. turning, with screws for tubes $\varnothing$ 14 mm (art. 7151 - 7166)
0000SM00098U	6. turning, with screws for tubes $\varnothing$ 18 mm
0000SM00112U	7. turning, with snap closure for tubes $\varnothing$ 22 mm

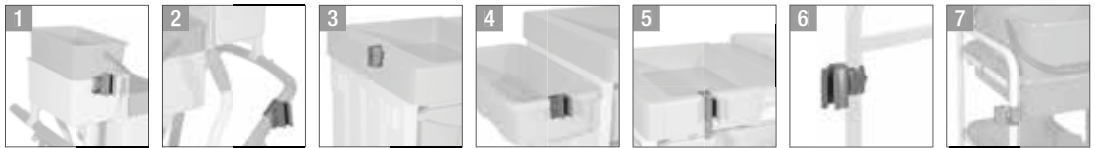

## Hooks

### Plastic hook



REF.	NOTES
0000SM00215U	1. for basket art. 60402A and bucket holder art. P220001E for Vega-Arka trolleys
0000SM00102U	2. fitting push-bar art. 7964A-7966A for Orion-Vega-Arka trolleys
60082U	3. for Delta bag holder - Alpha bag holder and closing profile
0000SM00205U	4. for Alpha and Morgan side basket
0000SM00212U	5. for Alpha central basket
8221U	6. turning, with screws for tubes $\varnothing$ 22 mm
0000SM00097U	6. turning, with screws for tubes $\varnothing$ 18 mm
8235	6. turning, with screws for tubes $\varnothing$ 14 mm (art. 7151 - 7166)
0000SM00113U	7. turning, with snap closure for tubes $\varnothing$ 22 mm



## Bis hooks

### BIS - double plastic hook

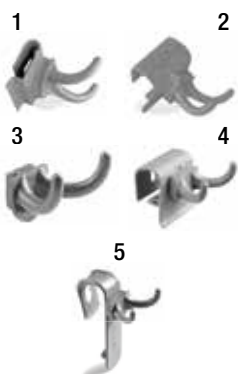

REF.	NOTES
0000SM00140U	1. for basket art. 60402A and bucket holder art. P220001E for Vega-Arka trolleys
0000SM00139U	2. fitting push-bar art. 7964A-7966A for Orion-Vega-Arka trolleys
60080U	3. for Delta bag holder - Alpha bag holder and closing profile
0000SM00141U	4. for Alpha and Morgan side basket
0000SM00208U	5. for Alpha central basket



CARRY BASKETS

PAPER HOLDERS  
FOR PAPER ROLLS

QUIVERS

DOOR STOPPERS

HOSES FOR  
BUCKET FILLING

NOTE BOARDS

**HOOKS**

BAGS

WHEELS

## Flip handle holders

### FLIP - handle holder with rubber roll



REF.	NOTES
0000SM00110U	1. for basket art. 60402A and bucket holder art. P220001E for Vega-Arka trolleys
0000SM00130U	2. fitting push-bar art. 7964A-7966A for Orion-Vega-Arka trolleys
0000SM00155U	3. for Delta bag holder - Alpha bag holder and closing profile
0000SM00121U	4. for Alpha and Morgan side basket
0000SM00209U	5. for Alpha central basket
0000SM00115U	6. with snap closure for tubes $\varnothing$ 22 mm

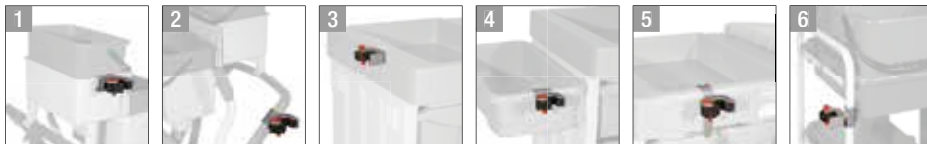

## Holdings for spray bottles

### Plastic holder for spray bottles

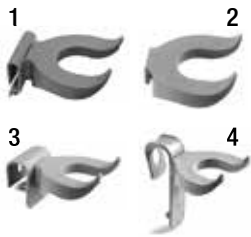

REF.	NOTES
0000SM00145U	1. for basket art. 60402A and bucket holder art. P220001E for Vega-Arka trolleys
P190208U	2. for Delta bag holder, Alpha bag holder and closing profile
0000SM00146U	3. for Alpha and Morgan side basket
0000SM00210U	4. for Alpha central basket

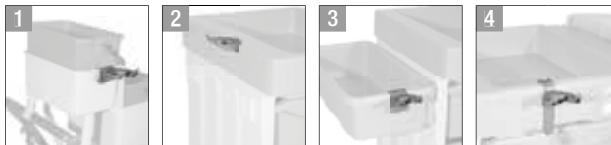

## Holdings for plastic hoses

### Plastic holder for hose $\varnothing$ 32 mm



REF.	NOTES
P190209U	1. for Delta bag holder, Alpha bag holder and closing profile
0000SM00149U	2. for Alpha and Morgan side basket
0000SM00211U	3. for Alpha central basket

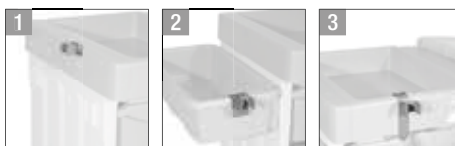



CARRY BASKETS

PAPER HOLDERS FOR PAPER ROLLS

QUIVERS

DOOR STOPPERS

HOSES FOR BUCKET FILLING

NOTE BOARDS

HOOKS

**BAGS**

WHEELS

## Plastified bags

Plastified bag with string



REF.	NOTES		CAPACITY (L)	SIZE (cm) ↓ ↓ ↓
0000AT0310A	for AlphaSplit trolley		45	33x24x63
0000AT0310B	for AlphaSplit trolley		45	33x24x63
0000AT0170A	for divider 1x40 L + 1x80 L		60	48x95
0000AT0170B	for divider 1x40 L + 1x80 L		60	48x95
0000AT0170E	for divider 1x40 L + 1x80 L		60	48x95
0000AT0160A	for divider 1x40 L + 1x80 L		80	57x93
0000AT0160B	for divider 1x40 L + 1x80 L		80	57x93
0000AT0160E	for divider 1x40 L + 1x80 L		80	57x93
0000AT0300A	for AlphaSplit trolley		90	47x30x63
0000AT0300B	for AlphaSplit trolley		90	47x30x63
0000AT0200A	for divider 100 L + 50 L		100	64,5x93
0000AT0200B	for divider 100 L + 50 L		100	64,5x93
3650A			120	73x97
3650B			120	73x97
0000AT0190A			150	79x98
0000AT0190B			150	79x98
0000AT0190E			150	79x98

## Bags with bottom grip

Plastified bag with bottom grip



REF.	NOTES		CAPACITY (L)	SIZE (cm) ↓ ↓ ↓
0000AT0120E			120	73x97

## Velcro bags

90l self-standing Velcro bag

**NEW**



REF.	NOTES
0000AT0185E	

For Morgan Hotel Light trolley bag holder

## Bags with eyelets and zipper



REF.	NOTES		CAPACITY (L)	SIZE (cm) ↓ ↓ ↓
0000AT0180C			120	60x79

For bag holder 120 L of Alpha trolleys

CARRY BASKETS

PAPER HOLDERS  
FOR PAPER ROLLS

QUIVERS

DOOR STOPPERS

HOSES FOR  
BUCKET FILLING

NOTE BOARDS

HOOKS

**BAGS**

WHEELS

## Plastified bags 50 L

Plastified bag



REF.	NOTES	CAPACITY (L)	SIZE (cm) ↓ ↓ ↓ ↓
0000AT0110A		50	60x32x64,5
0000AT0110B		50	60x32x64,5
0000AT0110E		50	60x32x64,5

## Mesh bags

Mesh bag with closing string



REF.	NOTES	CAPACITY (L)	SIZE (cm) ↓ ↓ ↓ ↓
0000AT0210A	polypropylene	30	30x60
0000AT0210B	polypropylene	30	30x60
0000AT0210C	polypropylene	30	30x60
0000AT0210F	polypropylene	30	30x60
0000AT0211A	polyester	50	30x90
0000AT0211B	polyester	50	30x90
0000AT0212A	stabilized polyester	70	60x90
0000AT0212B	stabilized polyester	70	60x90

Ideal for supports art. P1909914U, P1909926U and P1909927U

## Polyester bags

White polyester bag with coloured stripe



REF.	NOTES	CAPACITY (L)	SIZE (cm) ↓ ↓ ↓ ↓
8057A		150	55x55x94
8057B		150	55x55x94
8057C		150	55x55x94
8057F		150	55x55x94

For housekeeping trolleys

## Bags for laundry collection

White polyester bag with strings and button, with open side and coloured stripe, for laundry collection trolleys



REF.	NOTES	SIZE (cm) ↓ ↓ ↓ ↓
8181A	with blue stripe	54x101
8181B	with red stripe	54x101
8181C	with yellow stripe	54x101
8181F	with green stripe	54x101

# Accessories for trolleys



CARRY BASKETS

PAPER HOLDERS  
FOR PAPER ROLLS

QUIVERS

DOOR STOPPERS

HOSES FOR  
BUCKET FILLING

NOTE BOARDS





HOOKS

**BAGS**

**WHEELS**

White polyester bag with strings and button, completely closed, for laundry collection trolleys



REF.	NOTES	SIZE (cm) ↓ ↓ ↓
<b>8182A</b>	with blue stripe 	81x101
<b>8182B</b>	with red stripe 	81x101
<b>8182C</b>	with yellow stripe 	81x101
<b>8182F</b>	with green stripe 	81x101

Plastified bag for "X" laundry collection trolley



REF.	NOTES	CAPACITY (L)	SIZE (cm) ↓ ↓ ↓
<b>8052</b>	for art. 8043	150	46x32x90
<b>8052/1</b>	for art. 8044	180	53x92x82

## Different wheels

Wheel ø 35 mm



REF.	NOTES
<b>2793</b>	for Prisma, Twin, Top-Down®, Pick-Up, Trend and art. 0000SE1428

Wheel ø 50 mm



REF.	NOTES
<b>7949</b>	For King, Spider, Rocket Wheels, Duo Pro System, Prisma, Twin, Top-Down®, Pick-Up, Trend and code 0000SE1428

Wheel ø 80 mm



REF.	NOTES
<b>8063</b>	1. for Jack, Mini Jack, Filmop, Scala, Panda trolleys, laundry trolleys, wax application trolleys ref. 8042 - 8042/1
<b>8063/7</b>	2. for OneFred, Fred, Orion, Vega, Arka, Jumpy, Oscar, Twice and Maxi Jolly trolleys
<b>8063/6</b>	3. for Baby
<b>8063/4</b>	4. for art. 8045 and 8070

For even indoor floors

Wheel ø 80 mm with brake



REF.	NOTES
<b>8063/3</b>	1. for Jack, Mini Jack, Filmop, Scala, Panda trolleys, laundry trolleys, wax application trolleys ref. 8042 - 8042/1
<b>8063/9</b>	2. for Baby
<b>8063/10</b>	3. for art. 8045 and 8070

For even indoor floors

CARRY BASKETS

PAPER HOLDERS  
FOR PAPER ROLLS

QUIVERS

DOOR STOPPERS

HOSES FOR  
BUCKET FILLING

NOTE BOARDS

HOOKS

BAGS

**WHEELS**

## Wheel ø 100 mm

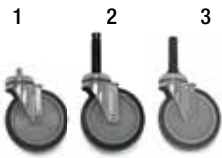

REF.	NOTES
8064	1. for Teddy, Jumbo and Ecology trolleys
8064/3	3. for Morgan trolleys

For even indoor floors

## Wheel ø 100 mm with brake



REF.	NOTES
8064/1	1. for Teddy, Jumbo and Ecology trolleys
8064/8	3. for Morgan trolleys

For even indoor floors

## Wheel Ø 100x28 mm

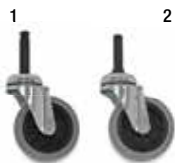

REF.	NOTES
23011262	1. for Alpha and Silver trolleys
33011262	2. for Morgan trolleys

For even indoor and outdoor floors

## Wheel Ø 100x28 mm with brake

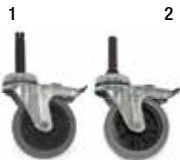

REF.	NOTES
23011272	1. for Alpha and Silver trolleys
33011272	2. for Morgan trolleys

For even indoor and outdoor floors

## Wheel ø 125x28 mm

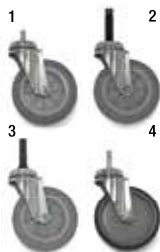

REF.	NOTES
2795	1. for Teddy, Jumbo, Ecology and Panda trolleys
23011250	2. for Alpha and Emotion trolleys
33011250	3. for Morgan trolleys
13011273	4. for supporting plate art. P314001U - Morgan Hotel trolleys

For even indoor and outdoor floors

## Wheel ø 125x28 mm with brake



REF.	NOTES
2795/1	1. for Teddy, Jumbo, Ecology and Panda trolleys
23011251	2. for Alpha and Emotion trolleys
33011251	3. for Morgan trolleys

For even indoor and outdoor floors



CARRY BASKETS

PAPER HOLDERS  
FOR PAPER ROLLS

QUIVERS

DOOR STOPPERS

HOSES FOR  
BUCKET FILLING

NOTE BOARDS

HOOKS

BAGS

**WHEELS**

## Rubber wheel $\phi$ 125 mm



REF.	NOTES
24011298	1. for Alpha and Silver trolleys
34011274	2. for Morgan trolleys
54011274	3. for supporting plastic plate ref. P314005U - for Morgan Hotel trolleys
64011274Q	4. for supporting plastic plate ref. P075130Q - for Emotion trolleys

Quiet castors for indoor floors

## Rubber wheel $\phi$ 125 mm with brake



REF.	NOTES
24011299	1. for Alpha and Silver trolleys
34011283	2. for Morgan trolleys

Quiet castors for indoor floors

## $\phi$ 150 mm rubber wheel



REF.	NOTES
24011295	1. for Alpha and Silver trolleys
34011276	2. for Morgan trolleys
54011276	3. for supporting plastic plate ref. P314005U - for Morgan Hotel trolleys
64011276Q	4. for supporting plastic plate ref. P075130Q - for Emotion trolleys

Quiet castors for indoor floors - Can take heavy loads

## Rubber wheel $\phi$ 150 mm with brake

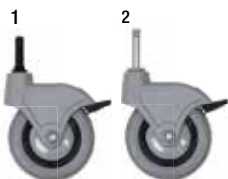

REF.	NOTES
24012296	1. for Alpha and Silver trolleys
34012301	2. for Morgan trolleys

Quiet castors for indoor floors - Can take heavy loads

## ■ Castors for bumper $\phi$ 130

### 125mm $\phi$ rubber castor with long pin for bumper item no. P190611U



REF.	NOTES
84011298	for Silver trolleys

CARRY BASKETS

PAPER HOLDERS  
FOR PAPER ROLLS

QUIVERS

DOOR STOPPERS

HOSES FOR  
BUCKET FILLING

NOTE BOARDS

HOOKS

BAGS

**WHEELS**

125mm  $\phi$  rubber castor with long pin for bumper item no. P190611U lockable



REF.	NOTES
84011299	for Silver trolleys

## Wheels for maxi bumper

Rubber wheel  $\phi$  125 mm with long pin for bumper art. P190610U



REF.	NOTES
44011298	1. for Alpha trolleys
44011298Q	2. for Emotion trolleys

Quiet castors for indoor floors

Rubber wheel  $\phi$  125 mm with long pin for bumper art. P190610U and brake



REF.	NOTES
44011299	1. for Alpha trolleys
44011299Q	2. for Emotion trolleys

Quiet castors for indoor floors

Rubber wheel  $\phi$  150 mm with long pin for bumpers ref. P190610U

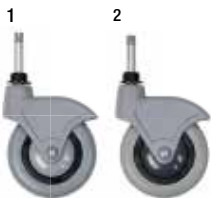

REF.	NOTES
44011295	1. for Alpha trolleys
44011295Q	2. for Emotion trolleys

Quiet castors for indoor floors - Can take heavy loads

Rubber wheel  $\phi$  150 mm with long pin for bumpers ref. P190610U and brake

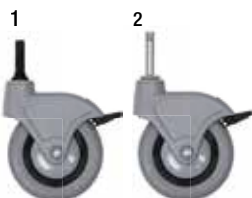

REF.	NOTES
44012301	1. for Alpha trolleys
44012301Q	2. for Emotion trolleys

Quiet castors for indoor floors - Can take heavy loads





CARRY BASKETS

PAPER HOLDERS  
FOR PAPER ROLLS

QUIVERS

DOOR STOPPERS

HOSES FOR  
BUCKET FILLING

NOTE BOARDS

HOOKS

BAGS

**WHEELS**

## Wheels with plate

Wheel Ø 100x28 mm with flange



REF.	NOTES
23011282	1. with rotating plate - for Alpha and Emotion (long base), Morgan and Morgan Hotel trolleys
23011284	2. with fixed plate - for Alpha and Emotion (long base), Morgan and Morgan Hotel trolleys
23011278	3. with rotating plate and brake - for Alpha and Emotion (long base), Morgan and Morgan Hotel trolleys

For even indoor and outdoor floors

Wheel Ø 125x35 mm with plate



REF.	NOTES
23011254	1. with rotating plate - for Alpha and Emotion (long base), Morgan and Morgan Hotel trolleys
23011255	2. with fixed plate - for Alpha and Emotion (long base), Morgan and Morgan Hotel trolleys
23011259	3. with rotating plate and brake - for Alpha and Emotion (long base), Morgan and Morgan Hotel trolleys

Rubber wheel Ø 125 mm with plate



REF.	NOTES
24011293	1. with rotating plate - for Alpha and Emotion (long base), Morgan and Morgan Hotel trolleys
24011294	2. with fixed plate - for Alpha and Emotion (long base), Morgan and Morgan Hotel trolleys
24011292	3. with rotating plate and brake - for Alpha and Emotion (long base), Morgan and Morgan Hotel trolleys

Quiet castors for indoor floors

Rubber wheel Ø 150 mm with plate



REF.	NOTES
24011264	1. with rotating plate - for Alpha and Emotion (long base), Morgan and Morgan Hotel trolleys
24011266	2. with fixed plate - for Alpha and Emotion (long base), Morgan and Morgan Hotel trolleys

Quiet smooth-gliding castors for indoor floors, including uneven floors

Rubber wheel for outdoor use Ø 200x50 mm with plate



REF.	NOTES
23011285	1. with rotating plate - for Alpha and Emotion trolleys (long base)
23011286	2. with fixed plate - for Alpha and Emotion trolleys (long base)

For outdoor floors - Can take heavy loads

Wheel Ø 200x45 mm with plate



REF.	NOTES
23011289	2. with fixed plate - for Alpha and Emotion trolleys (long base)
23011290	1. with rotating plate - for Alpha and Emotion trolleys (long base)

For indoor floors - Can take heavy loads - Can also be used on carpet

CARRY BASKETS

PAPER HOLDERS  
FOR PAPER ROLLS

QUIVERS

DOOR STOPPERS

HOSES FOR  
BUCKET FILLING

NOTE BOARDS

HOOKS

BAGS

**WHEELS**

## ■ ø 80 mm wheels with brake

Wheel ø 185 mm



REF.	NOTES
2797	1. for Scala and Panda trolleys
2798	2. for trolleys art. 8076-8077

Set of axial wheels ø 200 mm complete with screws

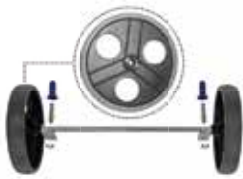

REF.	NOTES
0000SM00128	for plastic mopping trolleys

## ■ Bumpers

Maxi bumper ø 200 mm with rubber profile



REF.	NOTES
P190610U	for Alpha trolleys
P190610Q	for Emotion trolleys

Plastic bumper



REF.	NOTES
8065A	for mopping trolleys, single buckets, Panda and Teddy trolleys



Bumper with rubber outside



REF.	NOTES
8095	for Jumbo and Ecology trolleys

Bumper ø 85 mm



REF.	NOTES
P190600A	for Morgan trolleys 
P190600U	for Morgan Hotel trolleys 

Bumper ø 130 mm



REF.	NOTES
P190611U	for Silver and Morgan Hotel trolleys

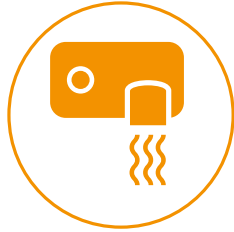

## Aura line

Hand towel dispensers

Toilet paper dispensers

Soap dispensers

Hairdryers

Air hand dryers

Bathroom accessories

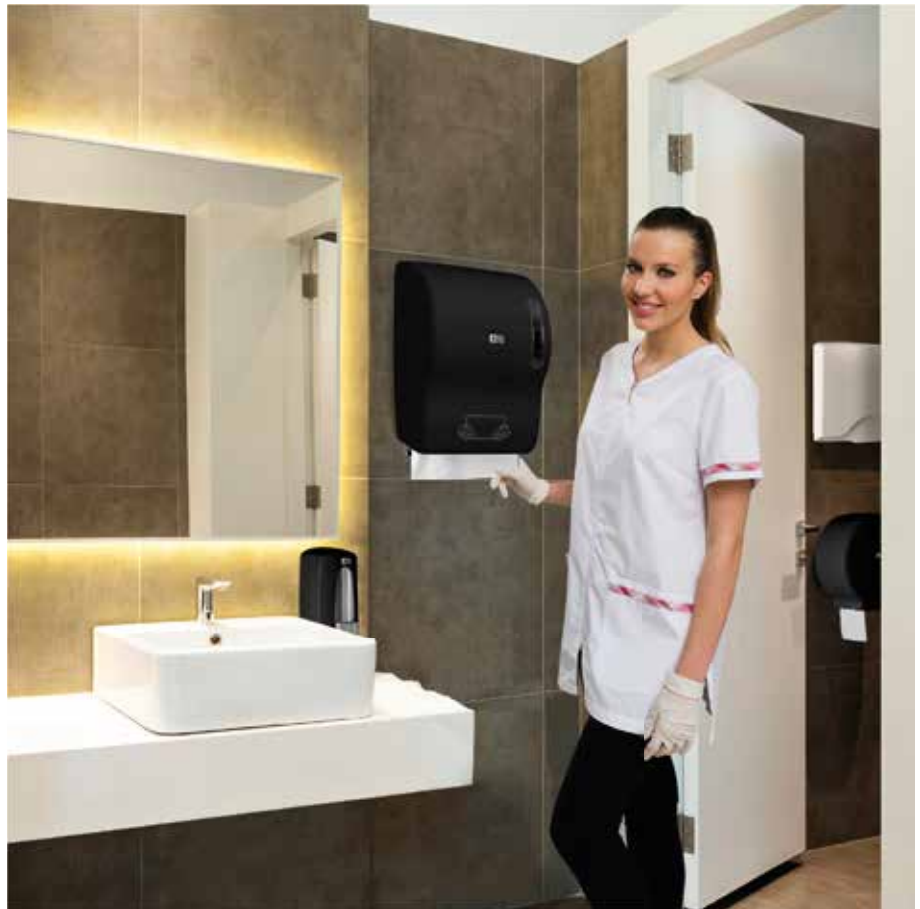

## Aura: bathroom furnishing with style!



**Aura** is a line of products particularly used in bathrooms. **Impeccable bathroom furnishing**, elegant and functional at the same time

- **STYLE:** the products of the Aura range feature stylish materials and different shades, capable of meeting all needs and offering perfect integration in all environments
- **ERGONOMICS:** what sets Aura apart is the ergonomic design, specifically conceived to make each product intuitive and easy to use.
- **HYGIENE:** Aura items and accessories have rounded shapes and smooth surfaces, making cleaning and maintenance easier and facilitating the preservation of hygiene standards

## **NEW** Fresh, Deluxe and Shine: the 3 new Aura ranges

Items made of **nickel-plated** plastic.

**Fresh** and **Deluxe** lines offer the possibility to customize restroom articles by printing your own logo in the tile made in two different colours.



## Stainless steel hand towel dispensers

Hand towel dispenser **TRAIL LINE** stainless steel for "C" or "Z" - shaped paper towels



REF.	NOTES	PCK	VOLUME (m <sup>3</sup> )	GROSS WEIGHT (kg)	SIZE (cm) ↓ ↓ ↓
AU1MS010A0	capacity 600 pcs	1	0,014	2,15	26,1x13,3x34,2

Hand towel dispenser **TRAIL LINE** stainless steel for towel roll ø 205 mm



REF.	NOTES	PCK	VOLUME (m <sup>3</sup> )	GROSS WEIGHT (kg)	SIZE (cm) ↓ ↓ ↓
AU1MR100A0		1	0,02	2,77	23x25x32

Hand towel dispenser **TRAIL LINE** stainless steel for towel roll ø 130 mm



REF.	NOTES	PCK	VOLUME (m <sup>3</sup> )	GROSS WEIGHT (kg)	SIZE (cm) ↓ ↓ ↓
AU1MR300A0		1	0,006	1,51	15x14x28

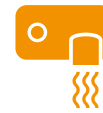

## Nickel-plated plastic dispensers for paper towels

Hand towel dispenser **SHINE LINE** nickel-plated plastic for "C" or "Z" - shaped paper towels

**NEW**

REF.	NOTES	PCK	VOLUME (m³)	GROSS WEIGHT (kg)	SIZE (cm) ↓ ↓ ↓
AU1MS020P9	capacity 600 pcs	1	0,014	0,85	27x13,5x35

**SHINE LINE** nickel-plated plastic dispenser for ø 210 mm paper towel roll with automatic cutter

**NEW**

REF.	NOTES	PCK	VOLUME (m³)	GROSS WEIGHT (kg)	SIZE (cm) ↓ ↓ ↓
AU1MR900P9		1	0,03	2,51	28,5x23,5x36

## White plastic hand towel dispensers

Hand towel dispenser **SNOW LINE** white plastic (ABS) for "C" or "Z" - shaped paper towels and paper roll ø 120 mm



REF.	NOTES	PCK	VOLUME (m³)	GROSS WEIGHT (kg)	SIZE (cm) ↓ ↓ ↓
AU1MD010P0	Capacity: 400 pcs / 1 roll ø 120 mm and 23, mm long	1	0,006	1,07	26x18x26

Hand towel dispenser **FRESH LINE** in white plastic (ABS) for "C" or "Z" - shaped paper towels

**NEW**

REF.	NOTES	PCK	VOLUME (m³)	GROSS WEIGHT (kg)	SIZE (cm) ↓ ↓ ↓
AU1MS020P0	capacity 600 pcs	1	0,014	0,85	27,5x13x36,5

Hand towel dispenser **SNOW LINE** white plastic (ABS) for towel roll ø 130 mm



REF.	NOTES	PCK	VOLUME (m³)	GROSS WEIGHT (kg)	SIZE (cm) ↓ ↓ ↓
AU1MR300P0		1	0,009	0,57	14,1x13,9x28,7

Hand towel dispenser **FRESH LINE** in white plastic (ABS) for towel roll ø 205 mm

**NEW**

REF.	NOTES	PCK	VOLUME (m³)	GROSS WEIGHT (kg)	SIZE (cm) ↓ ↓ ↓
AU1MR010P0		1	0,02	1,09	23x23x33,4



**HAND TOWEL DISPENSERS**

TOILET PAPER DISPENSERS

SOAP DISPENSERS

HAIRDRYERS

AIR HAND DRYERS

BATHROOM ACCESSORIES

**FRESH LINE** in white plastic (ABS) dispenser for  $\varnothing$  210 mm paper towel roll with automatic cutter

**NEW**



REF.	NOTES	PCK	VOLUME (m <sup>3</sup> )	GROSS WEIGHT (kg)	SIZE (cm) ↓ ↓ ↓
AU1MR900P0		1	0,03	2,51	28,5x23,5x36

## Black plastic dispensers for paper towels

Hand towel dispenser **DELUXE LINE** in black plastic (ABS) for "C" or "Z" - shaped paper towels

**NEW**



REF.	NOTES	PCK	VOLUME (m <sup>3</sup> )	GROSS WEIGHT (kg)	SIZE (cm) ↓ ↓ ↓
AU1MS020P7	capacity 600 pcs	1	0,015	0,85	27,5x13x36,5

Hand towel dispenser **DELUXE LINE** in black plastic (ABS) for towel roll  $\varnothing$  205 mm

**NEW**



REF.	NOTES	PCK	VOLUME (m <sup>3</sup> )	GROSS WEIGHT (kg)	SIZE (cm) ↓ ↓ ↓
AU1MR010P7		1	0,02	1,09	23x23x33,4

**DELUXE LINE** in black plastic (ABS) dispenser for  $\varnothing$  210 mm paper towel roll with automatic cutter

**NEW**



REF.	NOTES	PCK	VOLUME (m <sup>3</sup> )	GROSS WEIGHT (kg)	SIZE (cm) ↓ ↓ ↓
AU1MR900P7		1	0,03	2,51	28,5x23,5x36

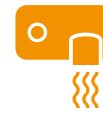

## Stainless steel toilet paper dispensers

Toilet paper dispenser **TRAIL LINE** stainless steel for toilet paper roll  $\phi$  220 mm 300 mt long



REF.	NOTES	PCK	VOLUME (m <sup>3</sup> )	GROSS WEIGHT (kg)	SIZE (cm) ↓ ↓ ↓
AU1CR020A0	$\phi$ 27 x 12,8 cm	1	0,011	1,44	12,8

$\phi$  fitting mandrel: 45 mm - 55 mm - 76 mm (76 mm with adaptor art. AU9C0004P0)

Toilet paper dispenser **TRAIL LINE** stainless steel for standard toilet paper roll



REF.	NOTES	PCK	VOLUME (m <sup>3</sup> )	GROSS WEIGHT (kg)	SIZE (cm) ↓ ↓ ↓
AU1CR500A0	capacity 2 rolls	1	0,005	1,47	15x14x28

**TRAIL LINE** stainless steel dispenser for interfold toilet paper



REF.	NOTES	PCK	VOLUME (m <sup>3</sup> )	GROSS WEIGHT (kg)	SIZE (cm) ↓ ↓ ↓
AU1CS010A0	capacity 400 pcs	1	0,008	1,46	14x14,5x28

## Nickel-plated plastic dispensers for toilet paper

Toilet paper dispenser **SHINE LINE** in nickel-plated plastic

**NEW**



REF.	NOTES	PCK	VOLUME (m <sup>3</sup> )	GROSS WEIGHT (kg)
AU1CR010P9	$\phi$ 27.8 x 13.5 cm - for roll $\phi$ 220 mm, 300 mt long	1	0,011	0,87
AU1CR030P9	$\phi$ 35.3 x 13.5 cm - for roll $\phi$ 310 mm, 500 mt long	1	0,019	1,23

$\phi$  fitting mandrel: 45 mm - 55 mm - 76 mm (76 mm with adaptor art. AU9C0004P0)

## White plastic toilet paper dispensers

Toilet paper dispenser **FRESH LINE** in white plastic (ABS) for maxi toilet paper roll

**NEW**



REF.	NOTES	PCK	VOLUME (m <sup>3</sup> )	GROSS WEIGHT (kg)
AU1CR010P0	$\phi$ 27.5 x 12 cm - for roll $\phi$ 220 mm, 300 mt long	1	0,01	0,61
AU1CR030P0	$\phi$ 33.5 x 12.5 cm - For rolls $\phi$ 260 mm, length 400 m	1	0,016	0,77

$\phi$  fitting mandrel: 45 mm - 55 mm - 76 mm (76 mm with adaptor art. AU9C0004P0)

HAND TOWEL DISPENSERS

**TOILET PAPER DISPENSERS**

SOAP DISPENSERS

HAIRDRYERS

AIR HAND DRYERS

BATHROOM ACCESSORIES

Toilet paper dispenser **SNOW LINE** white plastic (ABS) for standard toilet paper roll



REF.	NOTES	PCK	VOLUME (m <sup>3</sup> )	GROSS WEIGHT (kg)	SIZE (cm) ↓ ↓ ↓
AU1CR500P0	capacity 2 rolls	1	0,006	0,34	14,1x13,8x28,7

**SNOW LINE** white plastic (ABS) dispenser for interfold toilet paper



REF.	NOTES	PCK	VOLUME (m <sup>3</sup> )	GROSS WEIGHT (kg)	SIZE (cm) ↓ ↓ ↓
AU1CS010P0	capacity 400 pcs	1	0,006	0,34	14x14x28

## Black plastic dispensers for toilet paper

Toilet paper dispenser **DELUXE LINE** in black plastic (ABS) for maxi toilet paper roll

**NEW**



REF.	NOTES	PCK	VOLUME (m <sup>3</sup> )	GROSS WEIGHT (kg)
AU1CR010P7	ø 27.5 x 12 cm - for roll ø 220 mm, 300 mt long	1	0,01	0,61
AU1CR030P7	ø 34 x 12.5 cm - for roll ø 260 mm, 400 mt long	1	0,016	0,77

ø fitting mandrel: 45 mm - 55 mm - 76 mm (76 mm with adaptor art. AU9C0004P0)

## Liquid soap dispensers

Liquid soap dispenser **TRAIL LINE** stainless steel

**NEW**



REF.	NOTES	PCK	VOLUME (m <sup>3</sup> )	GROSS WEIGHT (kg)	SIZE (cm) ↓ ↓ ↓
AU3GP020A0	capacity 0.80 L	1	0,006	1,15	12,7x11x27,1

Liquid soap dispenser **JOLLY LINE** white plastic (ABS)



REF.	NOTES	CAPACITY (L)	PCK	VOLUME (m <sup>3</sup> )	GROSS WEIGHT (kg)	SIZE (cm) ↓ ↓ ↓
AU3GP200P0	capacity 1 L	0,8	1	0,003	0,47	13x9,5x23,3

Foam soap dispenser **SNOW LINE** white plastic (ABS)



REF.	NOTES	PCK	VOLUME (m <sup>3</sup> )	GROSS WEIGHT (kg)	SIZE (cm) ↓ ↓ ↓
AU3SP100P0	capacity 0,8 L	1	0,004	0,67	25x10,7x33,5





HAND TOWEL DISPENSERS

TOILET PAPER DISPENSERS

**SOAP DISPENSERS**

**HAIRDRYERS**

AIR HAND DRYERS

BATHROOM ACCESSORIES

Liquid soap dispenser **FRESH LINE** in white plastic (ABS)

**NEW**



REF.	NOTES	PCK	VOLUME (m <sup>3</sup> )	GROSS WEIGHT (kg)	SIZE (cm) ↓ ↓ ↓
AU3GP100P0	capacity 1 L	1	0,004	0,38	11,9x8,9x23,6

Liquid soap dispenser **SHINE LINE** in nickel-plated plastic

**NEW**



REF.	NOTES	PCK	VOLUME (m <sup>3</sup> )	GROSS WEIGHT (kg)	SIZE (cm) ↓ ↓ ↓
AU3GP200P9	capacity 0.9 L	1	0,003	0,48	13x10x23,5

**DELUXE LINE** dispenser in black plastic (ABS) for liquid soap

**NEW**



REF.	NOTES	PCK	VOLUME (m <sup>3</sup> )	GROSS WEIGHT (kg)	SIZE (cm) ↓ ↓ ↓
AU3GP100P7	capacity 1 L	1	0,004	0,46	11,9x8,9x23,6

**DELUXE LINE CONTROL** dispenser in black plastic (ABS) for liquid soap

**NEW**



REF.	NOTES	PCK	VOLUME (m <sup>3</sup> )	GROSS WEIGHT (kg)	SIZE (cm) ↓ ↓ ↓
AU3GP200P7	capacity 0.9 L	1	0,003	0,49	13x10x23,5

## Hairdryer with button

Hairdryer **DELUXE LINE** in black plastic (ABS) with bag

**NEW**



REF.	NOTES	PCK	VOLUME (m <sup>3</sup> )	GROSS WEIGHT (kg)	SIZE (cm) ↓ ↓ ↓
AU5HP310P7	Overall power: 1800 W	1	0,004	0,73	20,5x10x22

Hairdryer with button **SNOW LINE** white plastic (ABS)



REF.	NOTES	PCK	VOLUME (m <sup>3</sup> )	GROSS WEIGHT (kg)	SIZE (cm) ↓ ↓ ↓
AU5HP300P0	power 1200 W, class II	1	0,005	0,76	13x13x14,5

Hairdryer dimensions 17x7x18 cm, support dimensions 13x13x14,5 cm

## Automatic air hand dryers

### Automatic air hand dryer **TRAIL LINE** stainless steel



REF.	NOTES	PCK	VOLUME (m <sup>3</sup> )	GROSS WEIGHT (kg)	SIZE (cm) ↓ ↓ ↓
AU5MA010A0	power 2000 W, class II	1	0,028	4,06	28x22x21

### Automatic air hand dryers **CLASSIC LINE** white laquered



REF.	NOTES	PCK	VOLUME (m <sup>3</sup> )	GROSS WEIGHT (kg)	SIZE (cm) ↓ ↓ ↓
AU5MA010V0	power 2000 W, class II	1	0,025	4,9	28x22x21

### Automatic air hand dryer **TRAIL LINE** stainless steel



REF.	NOTES	PCK	VOLUME (m <sup>3</sup> )	GROSS WEIGHT (kg)	SIZE (cm) ↓ ↓ ↓
AU5MA100A0	power 2000 W, class I	1	0,028	4,1	23x14x31

### Automatic air hand dryer **SNOW LINE** white plastic (ABS)



REF.	NOTES	PCK	VOLUME (m <sup>3</sup> )	GROSS WEIGHT (kg)	SIZE (cm) ↓ ↓ ↓
AU5MA100P0	power 2000 W, class II	1	0,027	3,6	23x14x31

### **SNOW LINE** automatic high-pressure hand dryer made of white plastic (ABS)

**NEW**



REF.	NOTES	PCK	VOLUME (m <sup>3</sup> )	GROSS WEIGHT (kg)	SIZE (cm) ↓ ↓ ↓
AU5MA200P0	Overall power: 1400 w	1	0,028	4	26,5x17x33

### **SNOW LINE ERGONOMIC** automatic high-pressure hand dryer made of white plastic (ABS)

**NEW**



REF.	NOTES	PCK	VOLUME (m <sup>3</sup> )	GROSS WEIGHT (kg)	SIZE (cm) ↓ ↓ ↓
AU5MA500P0	power 1550 W, class II	1	0,062	8,49	32x18x54

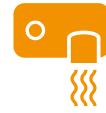

## Air hand dryers with button

### Air hand dryers with button **TRAIL LINE** stainless steel

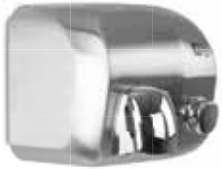

REF.	NOTES	PCK	VOLUME (m³)	GROSS WEIGHT (kg)	SIZE (cm) ↓ ↓ ↓
AU5MP010A0	power 2000 W, class II	1	0,028	4,06	28x22x21

### Air hand dryers with button **TRAIL LINE** white lacquered



REF.	NOTES	PCK	VOLUME (m³)	GROSS WEIGHT (kg)	SIZE (cm) ↓ ↓ ↓
AU5MP010V0	power 2000 W, class II	1	0,025	4,93	28x22x21

## Sanitary towel bag dispensers

### Sanitary towel bag dispenser **SNOW LINE** white plastic (ABS)



REF.	NOTES	PCK	VOLUME (m³)	GROSS WEIGHT (kg)	SIZE (cm) ↓ ↓ ↓
AU1AW200P0	capacity: 1 recharge with 25 bags	1	0,001	0,27	15,3x6,5x13,5

### High density polyethylene sanitary towel bags



REF.	NOTES	PCK	VOLUME (m³)	GROSS WEIGHT (kg)	SIZE (cm) ↓ ↓ ↓
AU9PAC1000	pck: 48 recharges with 25 bags	1	0,012	1,73	12,5x9x2

## Toilet seat cover dispensers

### Toilet seat cover dispenser **SNOW LINE** white plastic (ABS)



REF.	NOTES	PCK	VOLUME (m³)	GROSS WEIGHT (kg)	SIZE (cm) ↓ ↓ ↓
AU1AW210P0	capacity: 125 tissue paper	1	0,043	1,38	42x4x31

## Toilet brush

Toilet brush **TRAIL LINE** stainless steel



REF.	NOTES	PCK	VOLUME (m <sup>3</sup> )	GROSS WEIGHT (kg)	SIZE (cm) ↓ ↓ ↓
AU1AW220A0	ø 9 x 39 cm	1	0,004	0,89	39

## Dispenser accessories

Blank insert for Fresh and Deluxe line



REF.	NOTES	PCK	GROSS WEIGHT (kg)
AU9PRS1021		1	0,04
AU9PRS1020		1	0,04

Adaptor for toilet paper roll with mandrel ø 76 mm



REF.	NOTES	PCK	GROSS WEIGHT (kg)
AU9C0004P0		1	0,02



Index by item number

TECHNICAL CATALOGUE 2019

# Index by item number

ART.	PAGES	ART.	PAGES	ART.	PAGES
000010100A	29	0000247DA	16, 63	00009014FD	39
000010100F	29	0000264A	62	00009312DD	38
000010104A	27	0000265A	62	00009313AD	38
000010104B	27	0000311AA	51, 92	00009313BD	38
000010104C	27	0000311BB	51, 92	00009313CD	38
000010104F	27	0000311CC	51, 92	00009313DD	38
000010104H	27	0000311D	51, 92	00009313FD	38
000010105A	28	0000311FF	51, 92	00009314DD	38
000010105B	28	0000312D	51	0000AM30005	125
000010105C	28	0000511D	51, 92	0000AM30010	126
000010105F	28	0000512D	51	0000AM30015	125
000010105H	28	00005830	231	0000AM30015B	125
000010404A	27	00005835	231	0000AM30015C	125
000010404B	27	00005836	231	0000AM30015F	125
000010404C	27	00005850	231	0000AM30015U	125
000010404F	27	00005851	231	0000AM30020	126
000010404H	27	00005852	231	0000AM30025	125
000010405A	28	00005860	232	0000AM3040FZ	123, 354
000010405B	28	00005861	232	0000AM3045A	122
000010405C	28	0000611D	45	0000AM3045UA	122
000010405F	28	0000612D	46	0000AM3045UB	122
000010405H	28	00008116AB	43	0000AM3045UC	122
0000121AA	45	00008316AB	43	0000AM3045UF	122
0000121BB	45	00008916AB	43	0000AM3045UU	122
0000121CC	45	00009011AD	39	0000AM3060A	123
0000121D	45	00009011AH	39	0000AM3070A	106, 122
0000121FF	45	00009012AD	39	0000AM3070UA	106, 122
0000122D	46	00009012AH	39	0000AM3070UB	106, 122
000020100A	29	00009012BD	39	0000AM3070UC	106, 122
000020100F	29	00009012CD	39	0000AM3070UF	106, 122
0000204A	62	00009012DD	39	0000AM3070UU	106, 122
0000205A	62	00009012FD	39	0000AM3090A	106, 122
0000214AA	63, 119	00009013AD	39	0000AM3170A	122
0000214BB	63, 119	00009013AH	39	0000AS21150A	103
0000214CC	63, 119	00009013BD	39	0000AT0110A	442
0000214FF	63, 119	00009013CD	39	0000AT0110B	442
0000243DA	62, 72, 90, 118	00009013DD	39	0000AT0110E	442
0000244DA	62, 72, 90, 118	00009013FD	39	0000AT0120E	382, 441
0000244DB	62, 72, 90, 118	00009014AD	39	0000AT0160A	441
0000244DC	62, 72, 90, 118	00009014AH	39	0000AT0160B	441
0000244DF	62, 72, 90, 118	00009014BD	39	0000AT0160E	441
0000245DA	62, 72, 90, 118	00009014CD	39	0000AT0170A	441
0000246DA	16, 63	00009014DD	39	0000AT0170B	441

ART.	PAGES	ART.	PAGES	ART.	PAGES
0000AT0170E	441	0000C03030D	225	0000C04121D	201
0000AT0180C	441	0000C03031D	225	0000C04122D	201
0000AT0185E	403, 441	0000C03032D	225	0000C04123D	201
0000AT0190A	441	0000C03033D	225	0000C04124D	201
0000AT0190B	441	0000C03034D	225	0000C04220D	201
0000AT0190E	441	0000C03060D	225	0000C04221D	201
0000AT0200A	441	0000C03061D	225	0000C04222D	201
0000AT0200B	441	0000C03062D	225	0000C04223D	201
0000AT0210A	79, 442	0000C03063D	225	0000C04224D	201
0000AT0210B	79, 442	0000C03064D	225	0000C04300D	202
0000AT0210C	79, 442	0000C03090F	220	0000C05050D	217
0000AT0210F	79, 442	0000C03090I	220	0000C05050DUA	217
0000AT0211A	79, 442	0000C03091I	220	0000C05050DUB	217
0000AT0211B	79, 442	0000C03092I	220	0000C05050DUC	217
0000AT0212A	79, 442	0000C03093I	220	0000C05050DUD	217
0000AT0212B	79, 442	0000C03094I	220	0000C05050DUF	217
0000AT0300A	441	0000C03130D	225	0000C05050DUU	217
0000AT0300B	441	0000C03131D	225	0000C05050U	217
0000AT0310A	441	0000C03132D	225	0000C05150D	218
0000AT0310B	441	0000C03133D	225	0000C05150U	218
0000CO1017D	231	0000C03134D	225	0000C06170E	215, 300
0000CO1023D	231	0000C03160D	225	0000CP1104T	193
0000CO1120D	224	0000C03161D	225	0000CP1108U	188
0000CO1120F	224	0000C03162D	225	0000CP1114U	188
0000CO2010DE	236	0000C03163D	225	0000CP1122U	188
0000CO2012U	235, 306	0000C03164D	225	0000CP1128U	36, 183, 194
0000CO2017DE	237	0000C03190F	221	0000CP1204FZ	359
0000CO2023DE	237	0000C03190I	221	0000CP1204T	87, 193
0000CO2025D	237	0000C03191I	221	0000CP1205T	87, 193
0000CO2090I	221	0000C03192I	221	0000CP1206T	87, 193
0000CO2091I	221	0000C03193I	221	0000D225000	82
0000CO2092I	221	0000C03194I	221	0000D235000	82
0000CO2093I	221	0000C03230D	226	0000D250000	82
0000CO2094I	221	0000C03231D	226	0000D253000	82
0000CO2120D	224	0000C03232D	226	0000FD0501D	50
0000CO2120F	224	0000C03233D	226	0000FD0502D	51
0000CO2190I	222	0000C03234D	226	0000FD1401D	50
0000CO2191I	222	0000C03260D	226	0000FD1402D	51
0000CO2192I	222	0000C03261D	226	0000FD2401D	50
0000CO2193I	222	0000C03262D	226	0000FD2402D	50
0000CO2194I	222	0000C03263D	226	0000FS0122D	46
0000CO2910DE	236	0000C03264D	226	0000GI1001A	30
0000CO3023D	237	0000C04120D	201	0000GI1006A	30

# Index by item number

ART.	PAGES	ART.	PAGES	ART.	PAGES
0000GI1009A	30	0000LP0309A	141	0000MP3060A	313
0000GI2000A	31	0000LP0321A2	150	0000MP3080A	314
0000GI2001A	31	0000LP0322A2	150	0000MP4010A	314
0000GI2002A	31	0000LP1211A2	151	0000MP7010A	316
0000GI2003D	31	0000LP1221A2	151	0000MP7020A	316
0000HA5302U98	412	0000LP1401C	167	0000MP8010A	315
0000HP3100U	395	0000LP1402C	166	0000MP8020A	315
0000HP3101U	397	0000MA1100U00	257	0000OM0013D	81
0000HP3103U	397	0000MA1101U00	258	0000OM02230	81
0000HP3110Q5	384	0000MA1102U00	196	0000OM02530	81
0000HP3110U	396	0000MA1104U00	266	0000PA0101C	437
0000HP3140U	396	0000MA1105U00	266	0000PA01020U	29
0000HP3300U	389	0000MA1670U00	279	0000PA0102C	437
0000HP3301U	389	0000MA1671U00	279	0000PA0104C	437
0000HP3302U	390	0000MA1673U00	280	0000PA10300	26
0000HP3303U	390	0000MA2101U00	258	0000PA10400	25
0000HP3341U	394	0000MA2103U14	259	0000PA20300	26, 97
0000HP3342U	394	0000MA2672U00	281	0000PA20400	25, 97
0000HP3343U	395	0000MA4101U00	261	0000PM3000A	124
0000HP3360U	391	0000MA4103U00	268	0000PM3000B	124
0000HP3361U	392	0000MA5100U14	261	0000PM3000C	124
0000HP3362U	392	0000MA5101U00	262	0000PM3000D	124
0000HP3363U	393	0000MA5107U00	269	0000PM3000F	124
0000HP4273U	388	0000MA5108U18	270	0000PN01010	184
0000HP4274U	388	0000MA5109U00	271	0000PN02011	63, 72, 90, 119
0000HP4304U	391	0000MA5110U00	272	0000PN02012	63, 72, 90, 105, 119
0000HP4364U	393	0000MA5113U01	263	0000PN02016	105, 119, 184
0000HP4373U	387	0000MA5671U00	282	0000PN02030	71
0000HP4374U	387	0000MA6103U00	273	0000PN02040	67
0000LF0030YU	135	0000MA6105U00	263	0000PN02060	24
0000LF0031YU	136	0000MA6670U00	283	0000PN02069	24
0000LF0050YU	135	0000MA7103U00	198	0000PN03011	63, 72, 90, 119
0000LF0051YU	136	0000MP1000A	309	0000PN03012	63, 72, 90, 105, 119
0000LF1030YU	135	0000MP1010A	200	0000PN03016	105, 119, 184
0000LF1050YU	135	0000MP1030U	200	0000PN03021	63, 72, 90, 119
0000LM30003	124	0000MP1040A	310	0000PN03022	63, 72, 90, 105, 119
0000LM30023	124	0000MP1050A	311	0000PN04011	52, 93
0000LP0302A	140	0000MP1060A	311	0000PN04012	52, 93
0000LP0303A	141	0000MP2010A	312	0000PN04012EZ	354
0000LP0304A	140	0000MP2050A	309	0000PN0501	23
0000LP0305A	140	0000MP2150A	312	0000PN0502	23
0000LP0307A	141	0000MP3000A	310	0000PN06012	52, 93
0000LP0308A	140	0000MP3010A	313	0000PN07011	47



ART.	PAGES	ART.	PAGES	ART.	PAGES
0000PN07012	47	0000SE1210B	188	0000SM00122U	439
0000PN07032	47	0000SE1214A	188	0000SM00126	434, 435
0000SC00200	26	0000SE1214B	188	0000SM00128	448
0000SC00211	27	0000SE1214FT	188	0000SM00129U	439
0000SC01010	28	0000SE1222A	35, 108, 188	0000SM00130U	440
0000SC01020	28	0000SE1222B	35, 108, 188	0000SM00139U	439
0000SC10200	26	0000SE1222U	35, 108, 188	0000SM00140U	439
0000SE0104A	191	0000SE1308A	94, 187	0000SM00141U	439
0000SE0104B	191	0000SE1308B	94, 187	0000SM00145U	440
0000SE0104C	191	0000SE1308C	94, 187	0000SM00146U	440
0000SE0104F	191	0000SE1310A	94, 187	0000SM00147FZ	355
0000SE0104FAZ	359	0000SE1310B	94, 187	0000SM00149U	440
0000SE0104FBZ	359	0000SE1314A	94, 187	0000SM00155U	440
0000SE0104FCZ	359	0000SE1314B	94, 187	0000SM00163	293, 378, 418
0000SE0104FFZ	359	0000SE1314FT	94, 187	0000SM00165	293, 378, 418
0000SE0106U	191	0000SE1322A	94, 187	0000SM00165Z	355
0000SE0106UA	191	0000SE1322B	94, 187	0000SM00205U	439
0000SE0106UB	191	0000SE1322FAZ	359	0000SM00206U	439
0000SE0106UC	191	0000SE1322FBZ	359	0000SM00208U	439
0000SE0106UF	191	0000SE1322U	94, 187	0000SM00209U	440
0000SE0108A	190	0000SE1428A	36, 191	0000SM00210U	440
0000SE0108B	190	0000SE1428B	36, 191	0000SM00211U	440
0000SE0108C	190	0000SE1628U	182	0000SM00212U	439
0000SE0115UA	190	0000SE1725UB	170	0000SM00213U	303, 383, 401
0000SE0115UB	190	0000SL2601C	166	0000SM00214U	303, 383, 401
0000SE0125UA	190	0000SL2602C	162	0000SM00215U	439
0000SE0125UB	190	0000SL2700C	162	0000SM00227D	303, 383, 401
0000SE0204FAZ	359	0000SL2800C	165	0000SM00228D	303, 383, 401
0000SE0204FBZ	359	0000SLA30401	179	0000SM00244D	423
0000SE0204FCZ	359	0000SLA30402	179	0000SM00244E	423
0000SE0204FFZ	359	0000SM00030C	168	0000SM00245D	424
0000SE0204U	87, 191	0000SM00031U	168	0000SM00245E	424
0000SE0204UA	87, 191	0000SM00032H	168	0000SM00250U	438
0000SE0204UB	87, 191	0000SM00097U	439	0000SM00260	381, 420
0000SE0204UC	87, 191	0000SM00098U	439	0000SM00286	88
0000SE0204UF	87, 191	0000SM00100U	439	0000SM00297	324
0000SE0628U	182	0000SM00102U	439	0000SM00298	307
0000SE0725UB	170	0000SM00110U	440	0000SM00299	157
0000SE1128B	191	0000SM00111	224	0000SM00300	324
0000SE1208A	188	0000SM00112U	439	0000SM00301	308
0000SE1208B	188	0000SM00113U	439	0000SM00401	307
0000SE1208C	188	0000SM00115U	440	0000SM00402	382
0000SE1210A	188	0000SM00121U	440	0000SM00600	219

# Index by item number

ART.	PAGES	ART.	PAGES	ART.	PAGES
0000SM00602	400	0000TD0400A	73, 127	0020SE2742U	300
0000SM00603	400	0000TD0910AB	49, 89	0022LP0303A	141
0000SM00606	306	0000TD0920AB	49, 89	0022LP1280A	144
0000SM00607	400	0000TP0004AB	54	0022LP1281A	144
0000SM00610	216, 301	0000TP0005AB	54	0022LP1282A	145
0000SM00612	88	0000TP0303U	58	0022LP1283A	145
0000SM00617	292, 418	0000TP0304AB	54	0022LP1284A	146
0000SM00619	106	0000TP0904AB	54	0022LP1285A	146
0000SM00621	106	0000VA01010	29	0022SL2800C	165
0000SM00632	106	00018045A	205	00BL1000	308, 385, 420
0000SM00635	307	00018045B	205	00DU04L0L00	59
0000SM00640	430	00018070	205	00DU04L1L10	59
0000SM00645	307	00018075	206	00FC0402D00	55
0000SM0131I	223	0001TD0451A	70	00FM0401D00	55
0000SM0132I	223	0002TD1147A	33	00FM0501D00	55
0000SM0133I	224	0003CO4220D	202	00PD04LOA01AA	59
0000SM01340	223	00059078A	103	00PD04LOA01BA	59
0000SP1200D	421	00059081A	103	00PD04L0L00AA	58
0000SP1200E	421	00059082A	103	00PD04L0L00AB	58
0000SP1300D	421	00059083A	103	00PD04L0L00BB	58
0000SP1300D16	422	00059084A	104	00PD04L0L00CC	58
0000SP1300E	421	00059085A	104	00PD04L0L00FF	58
0000SP1300E16	422	00059086A	104	00PD04L0L10AA	59
0000SP1301D	422	00059087A	104	00PD04L0L10BA	59
0000SP1301D16	422	0005LP1250A	147	00PD04L0L30AF	58
0000SP1301E	422	0005LP1251A	147	00PD04L0L30BF	58
0000SP1301E16	422	0005LP1252A	147	00PD04L1L10AA	58
0000SP1310D	422	0005LP1253A	148	00PD04S0S00EE	58
0000SP1310E	422	0005LP1254A	148	00PN0309A00DA	62, 89, 119
0000SP2410E	423	0005LP1255A	149	00PN0309A00DB	62, 89, 119
0000SP2510E	423	0006LP1280A	142	00PN0309A00DC	62, 89, 119
0000TA0001A	21, 34	0006LP1281A	142	00PN0309A00DF	62, 89, 119
0000TD0010AB	49, 89	0006LP1282A	142	00PN0403A00	34, 64, 90
0000TD0020AB	49, 89	0006LP1283A	143	00PN0403A00E	34, 64, 90
0000TD0120A	69	0006LP1284A	143	00PN0403B00	52, 93
0000TD0130A	71	0006LP1285A	144	00PN0403B00E	52, 93
0000TD0145A	70	0006SL2800C	165	00PN0403C00	47
0000TD0151A	70, 385	0010SE0628U	182	00PN0403C00E	47
0000TD0151U	70, 385	0010SE0725UB	164	00PN0403D00	55
0000TD0161A	70, 385	0010SE1725UB	164	00PN0403D00E	55
0000TD0310AB	49, 89	0020SE0628U	182	00PN0403H00	64, 91
0000TD0320AB	49, 89	0020SE0725UB	164	00PN0403H00E	64, 91
0000TD0320FZ	354	0020SE1725UB	164	00PN0406A00	65, 91

ART.	PAGES	ART.	PAGES	ART.	PAGES
00PN0406A00E	65, 91	00PN0511D00	56	00TM0414D00	55
00PN0406B00	52, 93	00PN0513B00	53, 94	00TM0501B00	51
00PN0406B00E	52, 93	00PN0513B00E	53, 94	00TM0501C00	46
00PN0406C00	47	00PN0513D00	56	00TM0501D00	55
00PN0406C00E	47	00PN0513D00E	56	00TM0514B00	52
00PN0406D00	55	00PN0603A00	34, 64, 90	00TM0514C00	46
00PN0406D00E	55	00PN0603A00E	34, 64, 90	00TM0514D00	55
00PN0406H00	64, 91	00PN0603H00	64, 91	00TM0601A00	63
00PN0406H00E	64, 91	00PN0603H00E	64, 91	00TM0614A00	63
00PN0409A00DA	62, 89, 119	00PN0606A00	65, 91	0100LF0030YU	135
00PN0409A00DB	62, 89, 119	00PN0606A00E	65, 91	0100LF0050YU	135
00PN0409A00DC	62, 89, 119	00PN0606H00	64, 91	020P2199906EZ	356
00PN0409A00DF	62, 89, 119	00PN0606H00E	64, 91	020P2199907EZ	356
00PN0411A00	66, 92	00PN0609A00DA	62, 89, 119	03007960A/P	137
00PN0411B00	53, 94	00PN0609A00DB	62, 89, 119	03007965A/P	137
00PN0411C00	48	00PN0609A00DC	62, 89, 119	0300HA2300U05	410
00PN0411D00	56	00PN0609A00DF	62, 89, 119	0300HA3300U05	415
00PN0411H00	65, 92	00PN0611A00	66, 92	0300HA5300U06	411
00PN0413A00	65, 91	00PN0611H00	65, 92	0300HA5300U98	413
00PN0413A00E	65, 91	00PN0613A00	65, 91	0300HA5304U06	412
00PN0413B00	53, 94	00PN0613A00E	65, 91	0300HR5300U98	409
00PN0413B00E	53, 94	00PN0613H00	65, 92	0300MA5143U00	197
00PN0413C00	48	00PN0613H00E	65, 92	04007960A/P	138
00PN0413C00E	48	00PU0001000	23	04007965A/P	138
00PN0413D00	56	00PU0101000	23	0500HA5301U06	411
00PN0413D00E	56	00PU0102000	112	0500HA5301U98	413
00PN0413H00	65, 92	00PU0102001	112	0500MA2107U00	196
00PN0413H00E	65, 92	00PU0102002	113	0C08414	44
00PN0418A00A	64, 90	00PU0415A00	66, 67	0C08414/M	44
00PN0418A00B	64, 90	00PU0415B00	53	0C08420	44
00PN0418B00A	52, 93	00PU0416A00	66, 67	0C08420/M	44
00PN0418B00B	52, 93	00PU0416B00	53	0C08511	45
00PN0418C00A	47	00SSSL2601C	169	0C08511/M	45
00PN0418C00B	47	00SSSL2602C	168	0C08512	48
00PN0503B00	52, 93	00SSSL2700C	168	100/5212A	21
00PN0503B00E	52, 93	00SSSL2800C	168	100/5213A	21
00PN0503D00	55	00TM0401A00	63	10000A	174
00PN0503D00E	55	00TM0401B00	51	1000MA8104U00	275
00PN0506B00	52, 93	00TM0401C00	46	1000MA8125U00	198
00PN0506B00E	52, 93	00TM0401D00	55	1008	32
00PN0506D00	55	00TM0414A00	63	1012	32
00PN0506D00E	55	00TM0414B00	52	10200	234
00PN0511B00	53, 94	00TM0414C00	46	10201	234

# Index by item number

ART.	PAGES	ART.	PAGES	ART.	PAGES
10202	234	2036	79	2082F	171
10203	235	2036B	79	2084A	112
10204	235	2037	79	2085	112
10250	234	2037B	79	2085A	112
10300	233	2037C	79	2086	112
10305	233	2037F	79	21002	185
10315	234	2038	80	21003	193
1053A	125	2039	80	21004	189
1054	125	2040	80	21005U	183
1057	124	2040B	80	21021A	35, 185
1059	126	2040C	80	21030U	181
1063	125	2040F	80	21040U	181
1069E	126	2045	79	23011250	444
1070	124	2046	80	23011251	444
1084A	112	2051A	170, 192	23011254	447
1085	112	2051B	170, 192	23011255	447
1085A	112	2051C	170, 192	23011259	447
1086	112	2051F	170, 192	23011262	444
12000A	174	2060A	167	23011272	444
13011273	444	2060B	167	23011278	447
14000A	174	2061A	170	23011282	447
1400A	111	2061B	170	23011284	447
1402A	111	2062A	170	23011285	447
1422A	111	2062B	170	23011286	447
1430	113	2070A	164	23011289	447
1440A	111	2070B	164	23011290	447
16000A	192	2070C	164	24011264	447
1600A	111	2070F	164	24011266	447
1602A	111	2071A	171, 192	24011292	447
1622A	111	2071B	171, 192	24011293	447
1640A	111	2071C	171, 192	24011294	447
172000A	21	2071F	171, 192	24011295	445
172001A	21	2072A	171	24011298	445
18070	205	2072B	171	24011299	445
18075	206	2072C	171	24012296	445
2000CO4120D	202	2072F	171	2793	185, 186, 189, 194, 233, 443
2000CO4220D	202	2080A	164	2795	444
2000MA7101U00	274	2080B	164	2795/1	444
2000MA8100U00	264	2080C	164	2797	448
2012	113	2080F	164	2798	448
2015	127	2082A	171	3000CO4120D	202
2035	79	2082B	171	3000CO4220D	202
2035B	79	2082C	171		

ART.	PAGES	ART.	PAGES	ART.	PAGES
3000MA8670U00	285	3639A	323, 330, 340	44011295	446
3010	335	3639B	323, 330, 340	44011295Q	446
30141	328	3640	329, 338, 346	44011298	446
30300CL	328	3641A	323, 341	44011298Q	446
30302	329	3642	323, 341	44011299	446
3036	80	3644A	323, 330, 340, 346	44011299Q	446
3037	80	3644B	323, 330, 340, 346	44012301	446
3048	192	3645A	232	44012301Q	446
3050	331	3645B	232	50001	23
3054	331	3645C	232	50002	23
3061	332	3645E	232	50003	23
3064	332	3645F	232	50011	23
3072	333	3645G	232	50100S	23
3080	333	3645T	232	5101	15
3082	334	3647	339	5102	16
3090	334	3648A	233	5104	16
3100	209	3648B	233	5107	16
33011250	444	3648C	233	5111	14
33011251	444	3648E	233	5111/1	14
33011262	444	3648F	233	5112	14
33011272	444	3648G	233	5112/1	15
34011274	445	3648T	233	5114	15
34011276	445	3650A	441	5114/1	15
34011283	445	3650B	441	5117	15
34012301	445	3655	321	5126/2	15
3600	339	3657	329	5128/2	15
3601	338	3659	329	5136/2	15
3604	337	3663CL	337	5138/2	15
3606	337	3665	339	5141	14
3607	337	3667A	232, 340	5141/1	14
3610	338	3667B	232, 340	5142	14
3611	338	3667C	232, 340	5142/1	15
3612	338	3667E	232, 340	5144	15
3613	338	3667F	232, 340	5144/1	15
3614	339	3667G	232, 340	5147	15
3615	337	3667T	232, 340	5156/2	15
3624	337	3669U	107, 432	5158/2	15
3626	339	3671	329	5161	14
3631	339	3690U	107, 432	5161/1	14
3633	337	3691U	432	5162	14
3635U	432	4008A	22, 61, 67	5162/1	15
3637	337, 346	4028AB	22, 61, 67	5164	15
3638	329, 338	42100A	170	5164/1	15

# Index by item number

ART.	PAGES	ART.	PAGES	ART.	PAGES
5167	15	5240	22	5560	17
5176/2	15	5241	17	5706	16
5178/2	15	5241/PA	17	5716	15
5181	14	5247	22	5746	15
5181/1	14	5248	32	5766	15
5182	14	5251	18	5786	15
5182/1	15	5251/PA	18	5803	62
5184	15	5252A	21	5807	62
5184/1	15	5253A	32	5830	231
5187	15	5254A	21	5835	231
5201	18	5256	61	5836	231
5201/1	18	5259A	60, 88	5850	231
5201/21	18	5260A	60, 88	5851	231
5201/28A	18	5261	17	5852	231
5202	19	5261/PA	17	5860	232
5203	19	5263A	60, 88	5861	232
5206	23	5264A	66	5959A	61, 88
5210	23	5271	18	5960A	61, 88
5211	17	5271/PA	18	5964A	66
5211/PA	17	5278A	61	6000	76
5212A	21	5279A	61	60005A	173, 175, 177, 178
5213A	21	5281	17	6001	76
5215	22	5281/PA	17	60057	180
5216	22	5311A	17	60059	180
5217	22	5329A	37	60060	180
5219	22	5341A	17	60062U	22, 61, 107
5220	22	5342H	17	60068614	129
5221	18	5359A	60, 88	60068624	129
5221/PA	18	5360A	60, 88	60068654	129
5222	37	5361A	17	60072EZ	360
5222F	37	5362H	17	60072U	439
5222G	37	5364A	66	60080U	439
5222H	37	5381A	17	60082EZ	360
5223	21	5388U	105	60082U	439
5224	21	5389U	105	60107A	178
5225A	21	5390U	184	60108A	178
5228A	36	54011274	445	60119	230
5229A	36	54011276	445	60119A	230
5231	18	5442	18	60119B	230
5231/PA	18	5462A	18	60119C	230
5233U	89, 105, 118, 184	5503	19	60119E	230
5234U	89, 105, 118, 184	5540	17	60119F	230
5239	22	5544	48	60119G	230

ART.	PAGES	ART.	PAGES	ART.	PAGES
6013	76	6025A	81	6202DA	77
6014	76	6027F	81	6202DB	77
601421	233	60294U	185	6202DC	77
601422	233	60295A	155	6202DF	77
601424	233	6030	76	6204D	77
601425	233	60307A	177	6205D	77
601426	233	60308A	177	6206A	77
601428	233	6031	76	6207A	77
6015	76	60311H	177	6207B	77
60152A	170	6035	76	6207C	77
60152C	170	60356A	176	6207F	77
60156A	178	6036	76	6208A	77
6016	76	6040	82	6211A	78
60185	230	60402A	154, 433	6211D	78
60185A	230	60404U	433	6211DA	78
60185B	230	60405U	432	6211DB	78
60185C	230	60406Y	154	6211DC	78
60185E	230	6041	82	6211DF	78
60185F	230	6042	82	6300AA	80
60185G	230	6043	82	6300B	80
60193	230	6047	82	6300C	80
60193A	230	6048	82	6300D	80
60193B	230	60500	173	6300F	80
60193C	230	60501	173	6310B	80
60193E	230	60502	173	6310C	80
60193F	230	60503	173	6310D	80
60193G	230	6050A	76	6310F	80
6020A/1-10	78	6050B	76	6320A	81
6020A-10	78	6050F	76	6320B	81
6020B/1-10	78	6073	79	6320C	81
6020B-10	78	6074	79	6320F	81
6020C/1-10	78	6109	76	6400B	80
6020C-10	78	6110	76	6400C	80
6020F/1-10	78	6111	76	6400D	80
6020F-10	78	6112	76	6400F	80
6020U/1-10	78	6113	76	64011274Q	445
6020U-10	78	6201A	78	64011276Q	445
6021	79	6201D	77	7002A	176
60222	193	6201DA	77	7004A	172
60230	193	6201DB	77	7004E	172
60232	193	6201DC	77	701421	223, 227
60233U	330	6201DF	77	701422	223, 227
60234	340	6202D	77	701424	223, 227

# Index by item number

ART.	PAGES	ART.	PAGES	ART.	PAGES
701425	223, 227	7932AGB	169	8050	207
701426	223, 227	7932CGB	169	8052	430, 443
701428	223, 227	7940CGB	162	8052/1	430, 443
701431	223, 227	7941CGBSS	168	8053	210
701432	223, 227	7949	36, 108, 185, 186, 189, 194, 233, 443	8054	211, 430
701434	223, 227			8054	430
701435	223, 227	7960A	136	8054/1	211, 430
701436	223, 227	7960A/P	137	8055B	210
701436	227	7961A	138	8056DB	210
701438	223, 227	7961A/I	139	8057A	442
7106	342	7961A/P	139	8057B	442
7108	342	7962A	138	8057C	442
7151	344	7962A/I	139	8057F	442
7152	344	7962A/P	139	8058	212
7153	344	7963A	153	8062	161
7154	344	7964A	155	8062/1	161
7155	344	7965A	136	8063	443
7156	345	7965A/P	137	8063/1	443
7157CL	345	7966A	153	8063/3	443
7159	344	7970CGB	162	8063/4	443
7160CL	345	7971CGBSS	168	8063/6	443
7161CL	344	7990AGB	166	8063/7	443
7163	345	7990CGB	166	8063/9	443
7164CL	345	8000A	179	8064	444
7165	345	8002/1A	177	8064/1	444
7166	338, 345	8002A	177	8064/3	444
7167CL	346	8004A	179	8064/8	444
7169	337, 346	8010	158	8065A	448
7170	346	8016	158	8066	179
7200	343	8017	159	8068	180
72000A	20	8018	160	8070	205
72001A	20	8020	159	8071	211
72002A	20	8024	158	8072	211
7230	336	8032	159	8073B	212
7235	336	8036	160	8074	211
73000A	20	8040	207	8075	206
79000A	20	8042	205	8076	206
7914A	185, 35	8042/1	205	8077	206
7915A	186	8043	429	8077/1	206
7930AGB	166	8044	429	8079	211
7930CGB	166	8045A	205	8079/1	211
7931AGBSS	169	8045B	205	8080X	325
7931CGBSS	169	8049	209	8083X	209



ART.	PAGES	ART.	PAGES	ART.	PAGES
8089X	325	8169E	229	8225U	330, 340
8090X	326	8169F	229	8227	211, 329, 346
8092F	210	8169G	229	8229U	430
8095	448	8170	229	8234	328
8098X	326	8170/1	229	8235	439
8107A	190	8170/2	230	8252	329, 338
8107B	190	8170A	229	8253	329, 338
8108A	190	8170B	229	8257	347
8108B	190	8170C	229	8267	328
8115U	50	8170E	229	8269/1	424
8119AB	50	8170F	229	8271	213
8125AB	43	8170G	229	8272	213
8130AB	50	8171	213	8331SS	152
8132AB	50	8172	213	8332SS	152
8136	71	8174C	208	8335SS	152
8145G	235	8175	208	8337SS	152
8149	71	8181A	430, 442	8338SS	152
8150	33	8181B	430, 442	8369	228
8151	178	8181C	430, 442	8369A	228
8154	177	8181F	430, 442	8369B	228
8162	229	8182A	430, 443	8369C	228
8162/1	229	8182B	430, 443	8369E	228
8162A	229	8182C	430, 443	8369F	228
8162B	229	8182F	430, 443	8369G	228
8162C	229	8191F	208	8370	228
8162E	229	8200X	327	8370A	228
8162F	229	8203/2	328	8370B	228
8162G	229	8205	211	8370C	228
8167	214	8205/1	161	8370E	228
8168/1A	230	8205/2	210, 328	8370F	228
8168/1B	230	8211/1A	190	8370G	228
8168/1U	230, 385	8211/1B	190	8400A	210
8168A	230	8213	330, 340, 347	8400B	210
8168B	230	8214U	439	8400C	210
8168C	230	8215	161	84011298	445
8168F	230	8218A	191	84011299	446
8168U	230, 405	8218B	191	8414	44
8169	229	8218C	191	8414/M	44
8169/1	229	8218F	191	8420	44
8169/2	230	8220/1	212	8420/M	44
8169A	229	8220A	212, 330, 347	8422	50
8169B	229	8221U	439	8422/M	50
8169C	229	8223U	439	8423	50

# Index by item number

ART.	PAGES	ART.	PAGES	ART.	PAGES
8423/M	50	9007	39	9086A	104
8440	208	9008	39	9087A	104
8450	207	9009	39	9088A	104
8472	214	9020	31	9089/2A	104
8511	45	9021	31	9090A	104
8511/M	45	9022	32	9091	108
8512	48	9025	31	9095	108
8516	46	9026	32	9096A	104
8516A	46	9028	32	9100	34
8516B	46	9029	32	9101	99
8516C	46	9039	30	9102	99
8516F	46	9041	33	9103	99
8518/M	45	9044	33	9104	99
8571	214	9045	29	9105	100
8599	172, 179	9051	102	9106	100
8601	180	9052	102	9107	100
8608/1	179	9053	102	9108	100
8611U	330, 340, 347	9054	102	9109	34
8613	180	9055	102	9110	109
8614	129	9056	102	9111	109
8614.0	129	9057	102	9112	109
8614D	129	9058	103	9113	101
8614F	129	9059	103	9114	109
8614GB	129	9060	103	9114/1	109
8615	341	9061	102	9115	109
8617A	178	9063	102	9115/1	109
8623E	178	9064	102	9116	108
8624	129	9065	102	9117	108
8624.0	129	9066	102	9119	101
8624D	129	9067	102	9120	109
8624F	129	9068	102	9121	30
8624GB	129	9069	102	9122	30
8633A	176	9075	103	9131	99
8634	130	9076	103	9132	99
8640	172	9077	103	9133	99
8645	173	9078A	103	9134	99
8654	129	9079A	103	9135	100
8654.0	129	9080A	103	9136	100
8654D	129	9081A	103	9137	100
8654F	129	9082A	103	9138	100
8654GB	129	9083A	103	9141	99
8730YSS	152	9084A	104	9142	99
8731Y	153	9085A	104	9143	99

ART.	PAGES	ART.	PAGES	ART.	PAGES
9144	99	9333	99	AU1CR030P7	454
9145	101	9335	100	AU1CR030P9	453
9146	101	9336	100	AU1CR500A0	453
9147	34	9337	100	AU1CR500P0	454
9148	184	9351	102	AU1CS010A0	453
9149	101	9352	102	AU1CS010P0	454
9150	101	9353	102	AU1MD010P0	451
9151	37	9354	102	AU1MR010P0	451
9152	37	9355	102	AU1MR010P7	452
9153	37	9356	102	AU1MR100A0	450
9154	37	9357	102	AU1MR300A0	450
9161	100	9361	101	AU1MR300P0	451
9162	100	9400	34	AU1MR900P0	452
9163	100	9401	34	AU1MR900P7	452
9200/PRO	35	9402	34	AU1MR900P9	451
9206A	35, 108	9461	103	AU1MS010A0	450
9251	101	9501	99	AU1MS020P0	451
9252	101	9502	99	AU1MS020P7	452
9253	101	9503	99	AU1MS020P9	451
9254	101	9504	99	AU3GP020A0	454
9255	101	9505	100	AU3GP100P0	455
9256	101	9506	100	AU3GP100P7	455
9257	101	9507	100	AU3GP200P0	454
9261	101	9508	100	AU3GP200P7	455
9263	102	9531	99	AU3GP200P9	455
9264	102	9532	99	AU3SP100P0	454
9265	102	9533	99	AU5HP300P0	455
9266	102	9534	99	AU5HP310P7	455
9267	102	9535	100	AU5MA010A0	456
9268	102	9536	100	AU5MA010V0	456
9269	102	9537	100	AU5MA100A0	456
9271	102	9538	100	AU5MA100P0	456
9272	102	A1110810	175	AU5MA200P0	456
9301	99	A250004	130	AU5MA500P0	456
9302	99	A8644A	173	AU5MP010A0	457
9303	99	AU1AW200P0	457	AU5MP010V0	457
9305	100	AU1AW210P0	457	AU9C0004P0	458
9306	100	AU1AW220A0	458	AU9PAC1000	457
9307	100	AU1CR010P0	453	AU9PRS1020	458
9308	100	AU1CR010P7	454	AU9PRS1021	458
9310	132	AU1CR010P9	453	C30075CL	328
9331	99	AU1CR020A0	453	C30139CL	328
9332	99	AU1CR030P0	453	C30140/2	328

# Index by item number

ART.	PAGES	ART.	PAGES	ART.	PAGES
C30152	161	MA0701500U000	247	MX0236704U000	246
C3605CL	337	MA0706800U000	249	MX3336700U001	246
C3629CL	337	MA0706804U000	250	MZ0503700Z000	350
C3662	339	MA0706805U000	250	MZ0603700Z000	350
C8201CL	328	MA0706806U000	251	MZ0803700Z000	352
HA0603002U000	414	MA0706855U000	254	MZ0803701Z000	352
HA0603003U000	415	MA0801014U000	276	MZ1603702Z000	351
HA0603004U000	416	MA0801114U000	248	MZ3603701Z000	351
HA0603005U000	414	MA0801406U000	276	MZ3803702Z000	353
HA0648003U000	408	MA0801500U000	248	P0190047UA	183
HA0648005U000	408	MA0806700U001	286	P0190047UB	183
HR0603003U000	409	MA0806708U000	285	P0190049U	183
HR0603006U000	410	MA0806709U000	288	P019004U	318
I1050072	300	MA0806800U000	252	P025011U	290
I1900011	429	MA0806803U000	251	P025031U	290
I1900050	401	MA0848703U000	244	P025061U	290
I2190039	183	MA0901005U002	199	P059011U	290, 417
I2190044	189	MA0901006U000	197	P059031U	290, 417
L0220014	400	MA0901019U000	199	P059061U	290, 417
L4220013	400	MA2606701U000	243	P059361UX	290
L4220014	400	MA3301000U000	260	P06000A	104
L4220015	400	MA3306700U000	282	P064000A	321, 399
L5220013	400	MA3601400U000	273	P064000U	321, 399
MA0001000U000	267	MA3606700U000	284	P066011U	290, 417
MA0001003U000	259	MA3606705U000	288	P066031EZ	355
MA0001101U000	247	MA3801000U001	264	P066031U	290, 417
MA0101003U000	257	MA3801400U002	277	P066061U	290, 417
MA0101405U000	267	MA3801500U000	249	P066231Q	376
MA0201000U000	271	MA3806700U001	286	P066251Q	376
MA0206703U000	287	MA3806701U002	284	P066281Q	376
MA0301002U000	260	MA3806710U000	289	P074000A	321
MA0306702U000	287	MA3806711U000	289	P074000U	321
MA0401402U000	269	MA3806800U000	252	P075060Q	377
MA0401403U000	268	MA3806809U000	253	P075060U	291
MA0406700U000	280	MA3848400U002	244	P075130Q	377
MA0406701U000	281	MA3848711U000	245	P104001D	423
MA0501006U000	262	MA4601400U000	274	P104001E	423
MA0501414U000	270	MA4801400U002	277	P104002D	423
MA0506700U003	283	MR0601400U017	254	P104002E	423
MA0601000U000	272	MR0806703U000	256	P104003D	423
MA0601019U000	265	MR3606701U000	255	P104003E	423
MA0701402U000	275	MR3801400U000	255	P110004A	87
MA0701450U000	278	MR3806814U000	253, 256	P110014U	88

ART.	PAGES	ART.	PAGES	ART.	PAGES
P114011A	155	P166081Q	376	P190914I	222
P114021U	429	P166131Q	376	P190915I	222
P119001A	319	P166141Q	376	P190916A	305
P119001U	319	P166261Q	376	P190920U	320
P119002A	319	P175000Q	377	P190921U	320
P119002U	319, 405	P175000U	291, 417	P190926D	226
P119003A	319	P1780010	175	P190927U	429
P119003U	319	P1780029U	175	P190928U	429
P1190041U	95, 189	P179001A	434, 434, 435	P190938D	229
P1190042FZ	360	P179002A	154, 434, 434, 435	P190939D	229
P1190042U	95, 189	P179040A	123	P190972D	204
P1190043A	36	P179041A	111	P190973D	204
P1190044U	192	P179080U	424	P190974D	204
P1190048UB	184	P190010E	437	P190975N	204
P1190050U	192	P190020U	437	P1909901U	438
P119008U	324	P190060A	218	P1909914U	299
P1191100EZ	357	P190060B	218	P1909925U	95, 303
P1191100U	295, 384, 406, 419	P190060C	218	P1909926U	299
P1199900U	296	P190060D	218	P1909927U	299
P120004E	156	P190060F	218	P1909932U	193
P120007A	155, 435	P190060U	218	P1909933U	96, 304
P120008A	155, 435	P190061H	219	P1909937EZ	358
P1220203E	322	P1901109U	290	P1909937U	304
P1228802Q	380	P1901112U	296	P1909940U	433
P1229900U	302, 420	P1901113U	434, 434, 435	P1909948U	307
P1229906FZ	358	P190208U	440	P1909957U	299, 320, 381
P1229906U	95, 302, 383, 400	P190209U	440	P1909961U	95, 303
P1229906UX	302	P190301H	169	P1909966U	301
P1229907FZ	358	P190350E	94, 188	P1909967U	297
P1229907U	302, 383, 400	P190350FZ	359	P1909968U	297
P1229907UX	302	P190371H	169	P191000T	73, 97
P1229909U	95, 302, 383, 400	P190600A	448	P191021T	74
P130001Q	436	P190600U	448	P191045T	74
P159061Q	376	P190610Q	448	P191061E	22
P159081Q	376	P190610U	448	P191068U	61, 107
P159131Q	376	P190611U	448	P191069U	61, 107
P159141Q	376	P1908839E	378	P191070U	61, 107
P159261Q	376	P190908U	203, 218, 223, 306, 322, 359, 404, 420	P191071U	61, 107
P165000EZ	355			P191077U	61, 107
P165000Q	377	P190914A	222	P191084A	74
P165000U	291, 399, 417	P190914B	222	P191085U	61, 107
P165001U	291	P190914C	222	P191099U	73
P166061Q	376	P190914F	222	P1918802E	378

# Index by item number

ART.	PAGES	ART.	PAGES	ART.	PAGES
P1919969U	438	P2191102U	433	P2400F1C	131
P192000T	73, 97	P2191103U	433	P2400F3C	131
P1929969U	438	P2199904U	419	P2400F4B	131
P1948802E	378	P2199906U	294, 419	P240GB1C	131
P202001A	317	P2199907U	295, 419	P240GB2C	131
P202002A	317	P220001E	156	P240GB3C	131
P202008U	398	P2228800Q	379	P240GB4B	131
P202012U	398	P2228803Q	380	P250001C	130
P202017A	317	P2229906A	302, 322, 383, 400	P250002	131
P202050A	317	P2229906B	302, 322, 383, 400	P2780030	175
P202051U	398	P2229906FZ	358	P2780040	175
P202053A	317	P2229906U	302, 322, 383, 400	P2780060	175
P202058U	398	P2229906UX	302	P278006A	175
P202063U	398	P2229907FZ	358	P279042A	112
P202067A	317	P2229907U	302, 322, 383, 400	P281001E	155
P202075U	398	P2229907UX	302	P290068E	216, 301
P2031102U	291	P2229909U	302, 322, 383, 400	P290800A	154, 434, 434, 435
P2031103U	291	P2229910Q	382	P2908820Q	380
P2038805E	377	P2229911Q	382	P2908821Q	380
P2038806E	377	P2229911U	420	P2908822Q	380
P2038807E	378	P2229913U	301	P2908823Q	380
P2038808E	378	P2229914U	301	P290914A	222
P2039903E	292, 417	P224002E	156	P290914B	222
P2039903EX	292	P225001A	434	P290914C	222
P2039903FZ	355	P225004A	154, 434	P290914F	222
P2039904E	292, 417	P225005U	434	P290914I	222
P2039904FZ	355	P225006I	224	P290929A	430
P2039906E	292	P230001B	131	P290929B	430
P2059963E	294	P230001Q	436	P290929C	430
P206002A	154	P230002A	131	P290929F	430
P206003A	154	P230003C	131	P290934A	226
P206010E	156	P2300D3C	131	P290934B	226
P206020U	299, 320, 381	P2300F3C	131	P290934C	226
P206030U	299, 320, 381	P230GB3C	131	P290934D	226
P206040U	299, 320, 381	P2328801Q	380	P290934F	226
P210017TA	87	P240001C	131	P290976A	203
P210017TB	87	P240002C	131	P290976B	203
P210022TA	87	P240003C	131	P290976C	203
P210022TB	87	P240004B	131	P290976D	203
P219004U	404	P2400D1C	131	P290976F	203
P219005U	404	P2400D2C	131	P290977D	203
P219007U	433	P2400D3C	131	P290978D	203
P2191101U	433	P2400D4B	131	P290979D	203

ART.	PAGES	ART.	PAGES	ART.	PAGES
P290981D	203	P299001C	437	P390986D	203
P290989D	203	P3038804E	377	P390987D	203
P2909912EZ	357	P3059953E	293, 418	P3909915U	304
P2909912U	299	P3059953EX	293	P3909918U	304
P2909915U	304	P3059954E	293, 418	P3909952E	294
P2909918FZ	358	P3059954EX	293	P3909952FZ	356
P2909918U	304	P3059967E	294	P3909953FZ	356
P2909920EZ	357	P3059974E	294, 418	P3909954FZ	356
P2909920U	296	P3059977E	418	P3909955A	305
P2909920UX	296	P306010A	156	P3909955B	305
P2909921EZ	357	P306020U	299, 320, 381	P3909962U	304
P2909921U	296, 419	P314001U	398	P3909966U	302
P2909921UX	296	P314005U	398	P391070E	216, 300
P2909934E	318	P3199903EZ	356	P3928802E	379
P2909946A	305	P3199903U	295	P3938802E	379
P2909946B	305	P3199903UA	295	P3958802E	379
P2909946FZ	358	P3199903UB	295	P3968802E	379
P2909955A	305	P3199903UC	295	P402050U	317
P2909955B	305	P3199903UF	295	P402053U	317
P2909960U	297	P3199903UX	295	P402067U	317
P2909962U	304	P3199905U	295	P406020U	299, 320, 381
P2909966U	301	P3199905UA	295	P414001U	398
P291029A	73	P3199905UB	295	P414005U	398
P291029B	73	P3199905UC	295	P4199903U	295
P291029C	73	P3199905UF	295	P4199903UA	295
P291029F	73	P3199908U	419	P4199903UB	295
P291030A	73	P320100UA	87	P4199903UC	295
P291030B	73	P320101UA	87	P4199903UF	295
P291030C	73	P320200UA	87	P514000U	398
P291030F	73	P320201UA	87	P515010U	290
P291050H	67	P3228800QU	379	P515030U	290
P291051H	67	P3228801QU	380	P515060Q	376
P291070E	216, 300	P3229915U	303, 382	P515060U	290
P291918A	304, 322	P390300C	169	P515130Q	376
P291918B	304, 322	P3908833Q	380	P516010U	319, 403
P291918FZ	358	P3908834Q	380	P606010A	156
P291919A	304, 323, 381	P3908835Q	380	P716010U	319
P291919B	304, 323, 381	P3908836Q	380	P816010U	319, 403
P291919T	304, 323, 381	P390914A	223	P8161110U	297
P291920U	305, 323, 382, 404, 420	P390914B	223	P8161111U	297
P291920UA	305, 323, 382, 404, 420	P390914C	223	P8161111UX	297
P291920UB	305, 323, 382, 404	P390914F	223	P8161112U	297
P2919943U	305	P390914I	223	P8161113U	297, 419

# Index by item number

ART.	PAGES	ART.	PAGES	ART.	PAGES
P8161114EZ	357	Q1400123E	384	R2200041	321
P8161115U	297, 419	Q1400130G	401	R2200050	405
P8168800Q	381	Q1400210G	402	R2200051	406
P8168801Q	381	R1030010	317	R2200120	321
P8168802Q	381	R1030040	318	R2240030	433
P8168803Q	381	R1030103	318	R2240040	433
P8169900U	298	R1030113	399	R3010	335
P8169901U	298	R1030122	399	R3030133	96, 306
P8169903U	298	R1030125	318	R3030135	406
P8169904U	298	R1030134	318	R3061	332
P8169905EZ	357	R1030137	317	R3064	332
P8169905U	298	R1030142	399	R3090	334
P8169906U	298	R1030144	399	R3659	320
P8268800Q	380	R1030146	399	R7230	336
P8268801Q	380	R1030147	317	R7235	336
P8268802Q	380	R1040010	306, 321	R8017	159
P8268803Q	380	R1050040	157	R8018	160
P8269907U	298	R1050050	157	R8024	158
P906010U	319	R1180050	404	R8036	160
PA50028D	424	R1180080	384	R8061/1	153
Q0400070G	402	R1200020	320	R8061/2	153
Q0400073Q	384	R1200042	307	R8062	161
Q0400101G	402	R1200103	156	R8083X	209
Q0400102G	402	R1200104	156	R8089	325
Q0400103G	402	R1200113	157	R8090	326
Q0400104	404	R1200114	157	R8098	326
Q0400105A	72	R1230110	399	R8200	327
Q0400106B	72	R1230111	399	R8218	153
Q0400107A	73	R1230112	399	R8377	207
Q0400108	72	R1230113	399	R9156	428
Q0400117	404	R1900050	405	R9157	428
Q0400122P	403	R2030106	405	R9158	428
Q0400220G	403	R2030120	96, 322	R9159	429
Q0400221G	403	R2030154	434	R9166	427
Q0400230G	403	R2030161	399	R9167	427
Q0400231G	403	R2050010	324	R9168	427
Q1400010G	401	R2060010	320	R9169	427
Q1400011E	401	R2060031	298	R9176	425
Q1400030G	401	R2060080	405	R9177	426
Q1400050G	402	R2060081	403	R9178	426
Q1400090G	402	R2180085	384	R9179	426
Q1400110G	402	R2180400	231, 237	R9256	428
Q1400118U	404	R2200040	306, 320, 406	R9257	428



ART.	PAGES	ART.	PAGES	ART.	PAGES
R9266	426	TCH101030	115	TCH120029	117
R9267	427	TCH101039	115	TCH401020	116
R9276	425	TCH101040	115	TCH401029	116
R9277	426	TCH101049	115	TCH404030	117
SAC025	26, 97	TCH101120	115	TCH404039	117
SE0000020AE01	374	TCH101129	115	TCH601010	116
SE0104020AE01	375	TCH101210	115	TCH601019	116
SE0105020AE00	373	TCH101219	115	TCH601020	116
SE0105021AE00	373	TCH101220	115	TCH601029	116
SE0106020AE00	374	TCH101229	115	TCH601030	116
SE0300020AE00	364	TCH101230	115	TCH601039	116
SE0301020AE00	365	TCH101239	115	TCH601040	116
SE0301021AE00	365	TCH101240	115	TCH601049	116
SE0304004AE00	367	TCH101249	115	TCH602030	117
SE0304020AE00	366	TCH101410	116, 354	TCH602039	117
SE0304020PE00	363	TCH101419	116, 354	TCH603040	117
SE0305020AE00	368	TCH101420	116, 354	TCH603049	117
SE0305020PE00	364	TCH101429	116, 354	TCH803000	117
SE0305021AE00	368	TCH101430	116, 354	TCH803009	117
SE0306020AE00	370	TCH101439	116, 354	U100007	175
SE0306021AE00	370	TCH101440	116, 354	V1010801	175
SE0316020AE00	372	TCH101449	116, 354	V190062	219
SE0317020AE00	371	TCH101510	115	V2030122	96, 307, 322
SE0318021AE00	372	TCH101519	115	V8618	178
SE0400020PE02	363	TCH101520	115	V8632	176
SE0401021AE00	366	TCH101529	115	V8643	173
SE0404021AE00	367	TCH101530	115	Z2060104	212
SE0505021AE06	369	TCH101539	115	Z30130	180
SE0506021AE00	371	TCH101540	115	Z30131	180
SE0605021AE00	369	TCH101549	115	Z30132	180
SLP015000001D	218	TCH102020	116	Z30133	180
SLP015000001U	218	TCH102029	116		
SLP015000004D	219	TCH103020	117		
SLP015000004U	219	TCH103029	117		
SLP015000007H	219	TCH104010	114		
SLP015000009H	218	TCH104019	114		
T121012	111	TCH104020	114		
TA50029	424	TCH104029	114		
TA50066	424	TCH104030	114		
TCH101010	115	TCH104039	114		
TCH101019	115	TCH104040	114		
TCH101020	115	TCH104049	114		
TCH101029	115	TCH120020	117		

# General information

The items manufactured and sold by **FILMOP® INTERNATIONAL** Srl satisfy all safety requirements and are suitable for use. Colours, data, weights, descriptions and pictures in the current catalogue are to be considered as an indication.

**FILMOP® INTERNATIONAL** Srl, whose policy aims at continuous improvements, reserves the right to make all the necessary changes without notice and at any moment to its products.

The images, photos, drawings and any other representation of **FILMOP® INTERNATIONAL** Srl products, whether contained or not in catalogues, price lists, brochures and in any advertising material, belong exclusively to **FILMOP® INTERNATIONAL** Srl and, therefore, cannot be used in any form or in any way by customers or third parties without a specific written authorization by **FILMOP® INTERNATIONAL** Srl.

The commercialization or advertising of **FILMOP® INTERNATIONAL** Srl products in any way or by any means by customers or third parties cannot be made anonymously, but must always show **FILMOP® INTERNATIONAL** Srl logo, unless otherwise authorized by **FILMOP® INTERNATIONAL** Srl.

**FILMOP® INTERNATIONAL** Srl trademark on products or in advertising material cannot ever be erased, covered or made invisible. Any customer's trade mark may be added to **FILMOP® INTERNATIONAL** Srl logo, but avoiding any confusion concerning the identity of the manufacturer of the goods.



[www.filmop.com](http://www.filmop.com)





**FILMOP INTERNATIONAL s.r.l.** (Soc. a Socio Unico)  
 Via dell'Artigianato, 10/11 - 35010 VILLA DEL CONTE (PD) - ITALY  
 Tel. +39 049 9325066 - Fax +39 049 9325317  
 www.filmop.com - filmop@filmop.com

Reg. Imp. di PD / C.F.: 04848400281 - R.E.A.: PD n° 423341  
 Cod. ISO / VAT / P.IVA: IT 04848400281 - Cap. Soc. € 6.000.000 int. vers.



Certification valid for Rapido Super microfiber mop

Certification valid for Alpha trolley art. MA2606701U000

Distributor

